

\$1.25 ■ JAN. 1980

# Radio-Electronics®

THE MAGAZINE FOR NEW IDEAS IN ELECTRONICS

## SATELLITE TV

How to receive broadcasts

## CONFERENCE CALLER

Easy-to-build telephone accessory

## RADIO 73 YEARS AGO

The way it was in the 1900's

## HI-FI TURNTABLES

They do more than spin records

## DIGITAL SLOT MACHINE

Easy to build, fun to play

## IDENTIFY UNMARKED IC'S

Step-by-step how-to guide

## TRS-80 BREADBOARD

Application circuits and programs

## HOUSEHOLD ANDROIDS

Get started designing your own

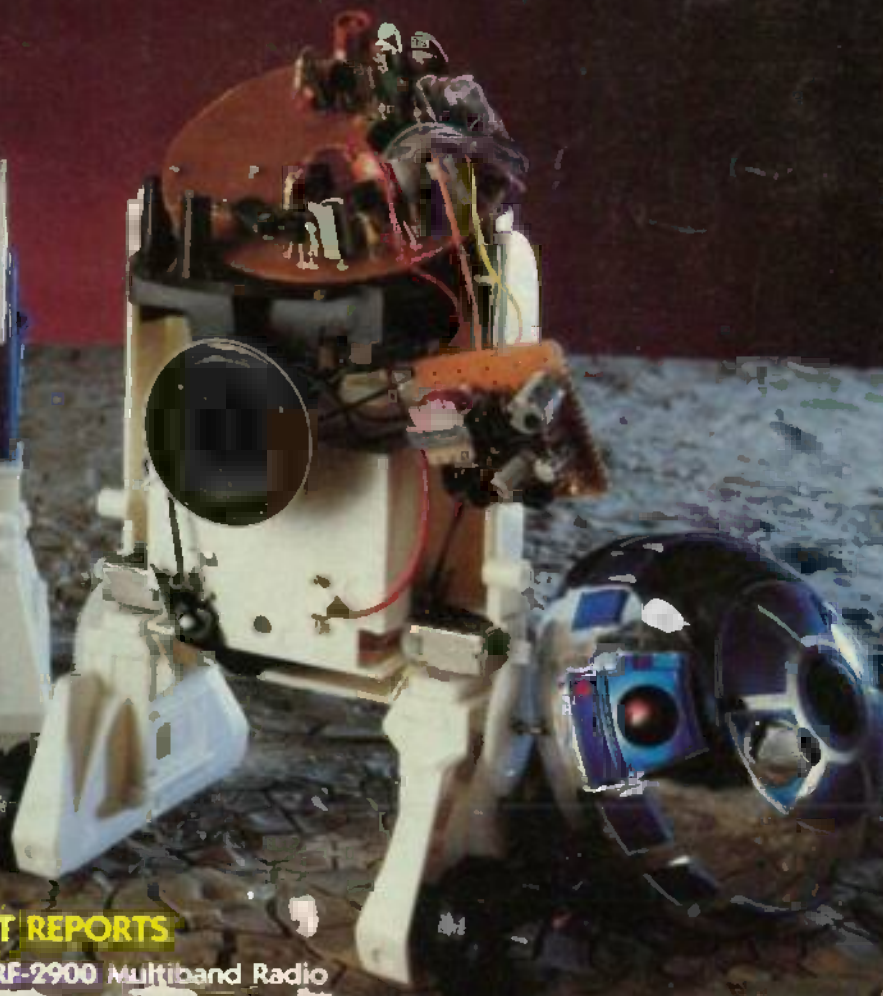

A  
GERNSBACK  
PUBLICATION

## EQUIPMENT REPORTS

Panasonic RF-2900 Multiband Radio  
Radio Shack Seven Stereo  
B&K E-200D RF Sig Gen



# First aid.

When digital circuitry isn't behaving as logically as it should, you need answers—fast. A quick, unambiguous look at what's happening. To show you at a glance the state of any point or port in the circuit.

That's the logic behind our logic probes. A pocket-size, circuit-powered family of multi-family instruments that dramatically cut the time (and cost) of diagnosing logic. They're quick enough to catch narrow pulses, one-shot events and transitions—to 10 nanoseconds and past 50 MHz—that even fast scopes might miss. They help keep track of pulse trains, even approximate the duty cycles of asymmetrical waveforms.

All with higher speed, precision, versatility and economy than any other testing method (or any other logic probes, for that matter).

Available singly, or in Logic Analysis Test Kits, with our Logic Monitors and Digital Pulser, CSC logic probes dramatically simplify maintenance and field service—as well as design, production and education.

CSC logic probes. When it comes to digital testing, no wonder so many people come to us.

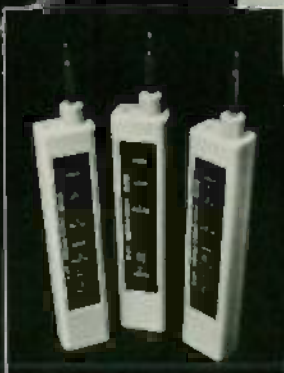

CSC logic probes capture pulses as narrow as 10 nanoseconds, to over 50 MHz. Priced from \$28.00 to \$77.00\*.

**Smarter tools for testing and design.**

CONTINENTAL SPECIALTIES CORPORATION



Call toll-free for details  
**1-800-243-6077**  
8:30AM-5:00PM Eastern Time

Fulton Terr., New Haven, CT 06509 (203) 624-3103, TWX 710-465-1227  
OTHER OFFICES: San Francisco (415) 421-8872; TWX 910-372-7992  
Europe: CSC UK LTD, Phone Saffron-Walden 0799-21682, TLX 817477  
Canada: Len Finkler Ltd., Ontario

\*Suggested US resale. Available at selected local distributors. Prices, specifications subject to change without notice. © Copyright 1979 Continental Specialties Corporation

CIRCLE 11 ON FREE INFORMATION CARD



# Power Chopper™

*A new invention by America's space agency will help all Americans save energy and make some companies very wealthy.*

Exxon has it. So does about a dozen other manufacturers. And if our hunches are correct, a new space-age product invented by NASA may not only save Americans millions of dollars but make fortunes for the companies that sell it.

The new NASA invention uses the latest space-age technology to save energy. Your refrigerator for example, is a major energy user. With this new device, your refrigerator compressor will run quieter, there will be considerably less heat generated from the motor, and it will run more efficiently saving up to 30% in energy.

The invention requires no installation. Just plug it into your outlet and plug your refrigerator into the device.

#### OVER PRICED UNIT

But there's a catch. Most manufacturers sell the device for as much as \$200. Using it with your refrigerator, it will take many years before it will pay dividends. On a powerful motor, however, the device will pay for itself much quicker.

Manufacturers who have announced their units are selling them like hot cakes. Although you may have heard a great deal of publicity about the product, you may not have seen any advertising because most manufacturers are currently sold out.

Watch for it! We predict great success for all those associated with the product. The power-saving device invented by NASA is a big hit. It will grow in popularity and save energy and make many companies very successful.

#### A SMALL COMPANY

There is one small company however, that is credited with improving the device and developing it for the consumer market. Called ERI (Electronic Relays, Inc.) the company has developed several models to service specific products such as a refrigerator, a washing machine, dishwasher, swimming pool and a typewriter.

This small company actually improved the NASA invention by adding its own refinements. ERI had a great deal of experience in solid state relays which use TRIACs and integrated circuits—two important elements in the NASA invention. A TRIAC is a bidirectional thyristor which controls AC from a single control input. TRIACs also produce a great deal of heat.

ERI's experience taught them how to control the TRIAC and its heat dissipation and thus they were able to reduce the device's cost through more efficient handling of the heat problem. They were already one of the nation's largest purchasers of TRIACs—thus

their costs were already low.

#### NATIONAL PUBLICITY

They called their product a Power Factor Controller and sent a sample to a national magazine for their review. In several tests, the device out-performed even the claims made by the manufacturer and the magazine ran a glowing article on their findings.

The manufacturer felt that the product might at first be misleading. Although it does save up to 30% on energy and in many cases up to 60%, ERI felt most consumers would expect a 30% reduction in their total electric bill—which of course the product will not do. Consumers will only get up to a 30% savings on the particular appliance used with the unit.

#### STILL PESSIMISTIC

The manufacturer also felt that the product was primarily for the industrial market—restaurants with large banks of refrigerators. The consumer must wait a few years before the device would pay for itself. And finally, the manufacturer did not feel that the consumer would respond in great numbers to the article which ran in the July, 1979 edition of *Popular Science* magazine.

Well, the consumer did respond. So much so that the small manufacturer, with absolutely no marketing staff, was buried with mail. The president of ERI called JS&A to help him out.

#### TEST ONE YOURSELF

We called it the Power Chopper and agreed to offer it to the consumer market for \$29.95—a major price breakthrough.

Even if Exxon lowers their prices considerably, they'll never come close to the low cost of the Power Chopper. ERI's expertise with the TRIAC and JS&A's direct-to-consumer marketing, make the new NASA invention a practical power-saving accessory for every home.



*The sophisticated electronics of the Power Chopper consist of a TRIAC, two integrated circuits and several solid-state devices.*

We urge you to test just the refrigerator module. Order one from JS&A on a 30-day no-obligation trial. In the meantime, while you are waiting for your unit, feel the heat generated from the bottom of your refrigerator. Listen to the sound level of your compressor.

When the Power Chopper arrives, plug it in and notice how much quieter and cooler your refrigerator runs. See how much less time the compressor must run. The compressor not

only will run more efficiently but will save energy every day you use it.

#### AWARD WINNER

If after 30 days you are not convinced that the Power Chopper will save you energy and money while making your refrigerator run smoother, then just unplug it and send it back for a prompt and courteous refund, including the \$2.50 postage and handling. But if you've definitely noticed the difference, you'll want to purchase more units for the remainder of your motor-based appliances.

JS&A feels that ERI's technology, their improved NASA design and their low manufacturing costs will catapult them to the forefront of those introducing the new NASA invention. ERI's Power Chopper is one of the nation's major new innovative products and just recently won the Industrial Research IR-100 Award.

To order your Refrigerator Power Chopper, send \$29.95 for each unit plus \$2.50 for postage and handling to JS&A Group, Inc., One JS&A Plaza, Northbrook, Illinois 60062. (Illinois residents please add 5% sales tax.) Credit card buyers may call our toll-free number below. We'll send your Refrigerator Power Chopper, one-year limited warranty and you'll be ready to save. If you wish to order additional units for other appliances at \$29.95, you may, but we suggest you test the refrigerator module first and totally convince yourself.

#### GOVERNMENT REBATE

Purchase of the Power Chopper entitles you to a full 15% energy tax credit on your income tax return. It's like having the government give you a \$4.50 rebate.

JS&A is America's largest single source of space-age products—further assurance that your purchase will be backed by service for years to come.

NASA technology was responsible for the development of the integrated circuit and many other space-age products. Their latest product could not have been developed at a better time. Start saving and order a Power Chopper at no obligation, today.

**JS&A** PRODUCTS  
THAT  
THINK

Dept. RA One JS&A Plaza  
Northbrook, Ill. 60062 (312) 564-7000  
Call TOLL-FREE ..... 800 323-6400  
In Illinois Call ..... (312) 564-7000

©JS&A Group, Inc., 1979

**BK PRECISION****PHILIPS****TRIPLETT VIZ *ראי* LEADER****HICKOK Hitachi Simpson****FLUKE NLS Non-Linear Systems****DORIC DATA PRECISION****SUPER SPECIAL****HICKOK 385  
500MHz COUNTER  
Reg 419<sup>95</sup>****NOW 199<sup>95</sup>**

LIMITED QUANTITIES

**Model L80-520  
30 MHz Dual Trace  
Scope with Delay Line**List Price \$1100  
**\$879<sup>95</sup>**

- High Sensitivity.  
Wide Bandwidth.  
Single Shot Trigger. P-D-A CRT.
- 5mV sensitivity facilities accurate signal viewing from low level sources
  - Built-in delay line makes it easy to view the leading edge of a pulse.
  - Single shot trigger (CH-1, CH-2) captures transient phenomena — no guesswork, no "double-takes".

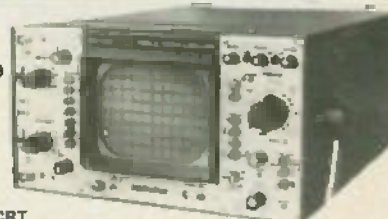
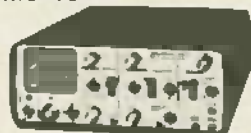
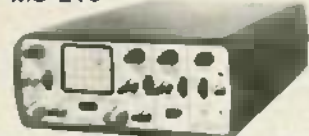
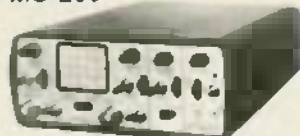
**PORTABLE  
OSCILLOSCOPES  
BATTERY OPERATED****NLS Non-Linear Systems****MS-15**Single Trace 15MHz  
Reg. price \$349.  
**\$299<sup>95</sup>****MS-215**Dual Trace 15 MHz  
Reg. price \$465.  
**\$399<sup>95</sup>****MS-230**Dual Trace 30MHz  
Regular price \$598  
**\$499<sup>95</sup>****New Portable Digital Capacitance Meter****BK PRECISION****MODEL 820**

Call For Our Price

- Measures CAPACITANCE from 0.1pF to 1 Farad
- Resolves to 0.1pF
- 10 ranges for accuracy and resolution
- 4 digit easy-to-read LED display
- 0.5% accuracy
- Special lead insertion slots or banana jacks
- Fuse protected
- Uses either rechargeable or disposable batteries
- Overrange indication

**New Low Distortion Function Generator****BK PRECISION****MODEL 3010**

- Generates sine, square and triangle waveforms
- Variable amplitude and fixed TTL square-wave outputs
- 0.1 Hz to 1MHz in six ranges
- Push button range and function selection
- Typical sine wave distortion under 0.5% from 0.1Hz to 100kHz
- Variable DC offset for engineering applications
- VCO external input for sweep frequency tests

**New Sweep/Function Generator****BK PRECISION****MODEL 3020**

- Four instruments in one package—sweep generator, function generator, pulse generator, tone-burst generator.
- Covers 0.02Hz-2MHz
- 1000:1 tuning range
- Low-distortion high-accuracy outputs
- Three-step attenuator plus vernier control
- Internal linear and log sweeps
- Tone-burst output on front panel or externally programmable

**8020A**

- 28 Ranges—5 Functions Plus New Conductance Function for up to 10,000 M $\Omega$  Leakage Measurements
- Extensive Overload and Transient Protection
- Rugged Construction—2 Year Warranty
- Hi/La Power Ohms for In-circuit Resistance and Diode Testing
- 10 M $\Omega$  AC/DC Input Impedance Doesn't Load Circuit
- 200 Hour, 9V-Battery Life—Low Battery Indicator
- Large LCD Readout—8000 Counts
- 0.1% Basic dc accuracy
- One-Hand Operation
- Complete with Battery and Test Leads

The new Fluke 8020A continues the standard of accuracy set by the highly acclaimed 8000A multimeter family. Many features set the 8020A apart as a truly exceptional instrument. Twenty-four ranges and 5 functions include measuring capability up to 1000V ac, 750V dc, 2A ac/dc and 20 mA Hi/La. Ohms are indicated for in-circuit resistance and diode test capability. In addition, a new Conductance function allows resistance and leakage measurements up to 10,000 M $\Omega$ , a must for circuit board and PCB component checking.

The 8020A has been designed with the user in mind and features exclusive one-hand operation. For harsh service environments, the 8020A has a rugged case and extensive overload/transient protection backed up by a 1-year warranty. Long-term stability (1-year calibration cycle) is accepted with only minor CB adjustments. Up to 200 hours of continuous operation can be expected from a single 9V alkaline battery.

**NOW  
\$169.****FREE CASE WITH 8020A** 0.1% Basic dc accuracy

	10 Vdc	10 Vrms	100 Vdc	100 Vrms	1000 Vdc
Range	0.5	0.5	100	100	1000
Resolution	100 $\mu$ V	100 $\mu$ V	1 $\mu$ A	1 $\mu$ A	0.20
Accuracy	0.25+D	1.0+D	0.75+D	0.5+D	0.2+D

**FLUKE DIGITAL MULTIMETERS**

**THE TEST EQUIPMENT SPECIALISTS**  
TOLL FREE HOT LINE  
**800-223-0474**



54 WEST 45th STREET, NEW YORK, N.Y. 10036 212-687-2224

**ADVANCE  
ELECTRONICS**

# Radio-Electronics®

THE MAGAZINE FOR NEW IDEAS IN ELECTRONICS  
Electronics publishers since 1908

JANUARY 1980 Vol. 51 No. 1

## SPECIAL FEATURES

- 37 **PUT AN ANDROID IN YOUR HOME**  
Hints on designing an intelligent robot. **Martin Weinstein**
- 55 **BACKYARD SATELLITE TV RECEIVERS**  
So you want to build an inexpensive earth station—we'll here's what you need to know. **Robert Cooper**

## BUILD

- 40 **SLOT MACHINE**  
Easy to build; fun to use. Hit the jackpot if you can. **Fred Blechman and David McDonald**
- 49 **CONFERENCE CALLER FOR YOUR PHONE**  
Add one to your phone today. **Jules Gilder**
- 52 **TRS-80 BREADBOARD**  
Part 3: Now that it's complete here are some practical applications. **Jon Titus, Chris Titus, David Larsen**

## TECHNOLOGY

- 5 **LOOKING AHEAD**  
Tomorrow's News Today. **David Lachenbruch**
- 45 **HOW TO IDENTIFY UNMARKED IC's**  
Computer board bargains really pay off when you know how. **Kirtland H. Olson and Ann L. Zevnik**
- 50 **50 YEARS OF RADIO**  
Reprinted from 1956, this article tells how radio was 73 years ago.
- 66 **NEW IDEAS**  
A winning circuit application from our readers.
- 68 **HOBBY CORNER**  
Easy to build circuit monitors sound level; lets you know if it rises above or falls below a preset level. **Earl (Doc) Savage**

## STEREO

- 60 **R.E.A.L. SOUND LAB TESTS REALISTIC RECEIVER**  
Realistic model STA-2200 rates Very Good. **Len Feldman**
- 63 **WHAT'S IMPORTANT IN TURNTABLE DESIGN**  
A look at the factors in turntable design that affect how your records wear and play. **Len Feldman**

## VIDEO

- 74 **JACK DARR'S SERVICE CLINIC**  
Christmas-tree pattern reveals itself again. **Jack Darr**
- 74 **SERVICE QUESTIONS AND ANSWERS**  
R-E's Service Editor solves technician problems.

## RADIO

- 72 **COMMUNICATION CORNER**  
Recording tells all about shortwave listening plus a tri-band monitor antenna. **Herb Friedman**

## EQUIPMENT REPORTS

- 24 **PANASONIC RF-2000 PORTABLE MULTIBAND RADIO**
- 26 **RADIO SHACK SYSTEM SEVEN STEREO**
- 32 **B & K E-200D RF SIGNAL GENERATOR**

## DEPARTMENTS

- |                              |                    |
|------------------------------|--------------------|
| 102 Advertising Index        | 81 Market Center   |
| 12 Advertising Sales Offices | 77 New Products    |
| 12 Editorial                 | 79 Stereo Products |
| 103 Free-Information Card    | 14 What's News     |
| 22 Letters                   |                    |

## ON THE COVER

The radio-controlled R2-D2™ robot toy manufactured by Kenner Products contains two PC boards, 3 motors, a 3-cell battery pack and even a speaker, but it has nowhere near the capability of a true android. To find out what a household android would require and how you can go about designing your own, turn to page 37.

TM-Trademark of Twentieth Century-Fox Film Corp. Character. Copyright 1977, Twentieth Century-Fox Film Corp.

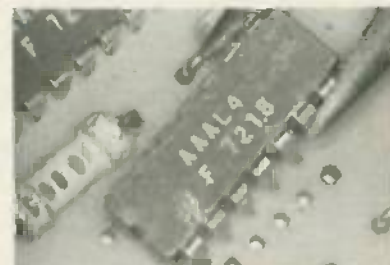

IDENTIFYING UNMARKED IC's can be a real headache unless you know how to go about it. The full story starts on page 45.

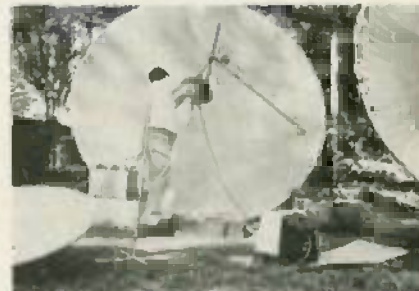

THIS INEXPENSIVE SATELLITE ANTENNA makes backyard reception of satellite TV broadcasts a reality. If you're interested in building an inexpensive earth station, turn to page 55.

Radio-Electronics, Published monthly by Gernsback Publications, Inc., 200 Park Avenue South, New York, NY 10003. Phone: 212-777-6400. Controlled Circulation Postage Paid at Concord, NH. One-year subscription rate: U.S.A. and U.S. possessions, \$9.98, Canada, \$12.98. Other countries, \$14.98. Single copies \$1.25. © 1979 by Gernsback Publications, Inc. All rights reserved. Printed in U.S.A. (ISSN 0033-7882)

Subscription Service: Mail all subscription orders, changes, correspondence and Postmaster Notices of undelivered copies (Form 3579) to Radio-Electronics Subscription Service, Box 2520, Boulder, CO 80322.

A stamped self-addressed envelope must accompany all submitted manuscripts and/or artwork or photographs if their return is desired should they be rejected. We disclaim any responsibility for the loss or damage of manuscripts and/or artwork or photographs while in our possession or otherwise.

As a service to readers, Radio-Electronics publishes available plans or information relating to newsworthy products, techniques and scientific and technological developments. Because of possible variances in the quality and condition of materials and workmanship used by readers, Radio-Electronics disclaims any responsibility for the safe and proper functioning of reader-built projects based upon or from plans or information published in this magazine.

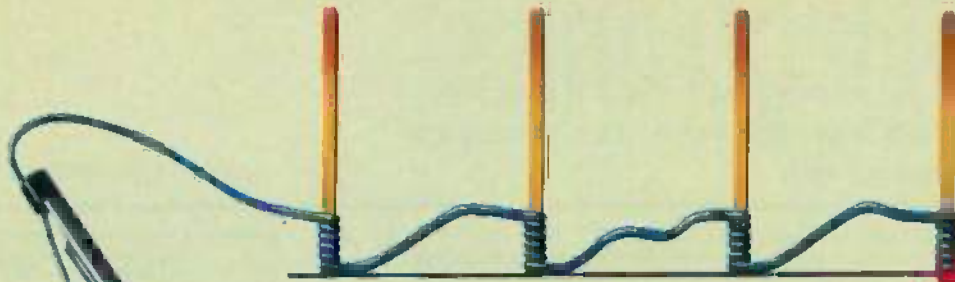

WHY CUT? WHY STRIP? WHY SLIT?  
WHY NOT...



# JUST WRAP™

WIRE WRAPPING TOOL

- AWG 30 Wire
- .025" Square Posts
- Daisy Chain or Point To Point
- No Stripping or Slitting Required
- ...JUST WRAP™...
- Built In Cut Off
- Easy Loading of Wire
- Available Wire Colors:  
Blue, White, Red & Yellow

traditional Wire-Wrapping



JUST WRAP Wire-Wrapping



U.S.A. FOREIGN  
PATENTS PENDING

JUST WRAP TOOL WITH ONE 50 FT. ROLL OF WIRE		
COLOR	PART NO.	U.S. LIST PRICE
BLUE	JW-1-B	\$ 14.95
WHITE	JW-1-W	14.95
YELLOW	JW-1-Y	14.95
RED	JW-1-R	14.95
REPLACEMENT ROLL OF WIRE 50 FT.		
BLUE	R-JW-B	\$ 2.98
WHITE	R-JW-W	2.98
YELLOW	R-JW-Y	2.98
RED	R-JW-R	2.98
JUST WRAP-UNWRAPPING TOOL		
	JUW-1	\$ 3.49



OK MACHINE & TOOL CORPORATION 3455 CONNER ST.,  
BRONX, N.Y. 10475 (212) 994-6600/TELEX 125091

\* MINIMUM BILLING \$ 25.00/ADD SHIPPING CHARGE \$ 2.00/NEW YORK CITY/STATE RESIDENTS ADD APPLICABLE TAX.

CIRCLE 15 ON FREE INFORMATION CARD

# looking ahead

**Earth-station bonanza:** The direct satellite-to-home market is expected to open up wide as a result of the latest FCC action—virtual “deregulation” of receive-only earth stations. This followed by two months the Commission’s decision to “routinely” grant such applications (*Radio-Electronics*, November 1979). Under the new ruling, an earth station may now be built without any license and without the necessity for frequency coordination. This opens the way for the use of dishes smaller than 4.5 meters, which generally has been the minimum size the FCC would approve. It also means cheaper and faster installations.

Sidney Topol, chairman and president of Scientific-Atlanta, hailed the decision as opening the way to thousands of home receiving stations. The FCC proposed that operators who want the anti-interference protection of frequency coordination should be able to use a “self-licensing” procedure by simply notifying the Commission of their intention to build the station following frequency coordination—but amateurs aren’t expected to follow that procedure. This doesn’t mean that privately owned programs are now free to all. The Commission noted that copyright statutes and the Crime Control Act are adequate to take care of this problem, along with scrambling. The last-named is now being explored by companies which provide programming for pay cable.

**Victory for tapists:** A tapist, in my lexicon, is someone who tapes TV programs off the air (“taper” sounds too much like some kind of South American animal). Anyway, tapists won an important victory in Los Angeles District Court when Judge Warren Ferguson ruled that the home videotaping of copyrighted television programs for personal use is completely legal. In the suit brought by MCA and Walt Disney Studios against Sony and others, the judge ruled flatly: “Non-commercial home-use recording of material broadcast over public airwaves does not constitute copyright infringement.” He specifically said his ruling didn’t apply to pay TV, cable TV, tape-swapping or home duplication of copyright tapes because these weren’t included in the suit.

**High-resolution home TV:** Have you often wondered why somebody hasn’t developed a compatible television broadcast system with double the number of lines of today’s TV to make possible high-resolution television for those who want it? Well, so have I. And we can stop wondering right now. Because such a system is under development. By the Japanese, of course—and anything they do must be taken seriously. It’s too early to say much about it, but watch this space. With the development of giant-screen projection, and eventually electroluminescent TV displays, this is bound to be one of the hottest topics of the 1980’s—not only in Japan, but in North America and Europe. Remember where you read this first.

**Videodisc progress:** The optical videodisc is gaining new adherents in Japan. Sony and Philips have agreed to cross-license videodisc and videotape developments, giving Sony access to Philips’ patents on the optical disc system. Sony has already built, and is demonstrating, an optical system compatible with the Philips/MCA technique.

Sharp of Japan has taken out a license to build a Philips-type disc player. And at the Japan Electronics Show, Sanyo and Toshiba also displayed optical disc systems. But all of this doesn’t necessarily mean the optical technique will sweep the videodisc field. Toshiba is a licensee of the RCA capacitance disc system and has demonstrated an RCA-compatible machine. Sanyo is a licensee of the Telefunken-Decca TED mechanical system. Sony has also signed a cross-licensing pact with Matsushita and JVC covering videodisc developments. Matsushita has developed the Visc-O-Pac mechanical system and JVC developed a capacitance system. What this means is that the Japanese are keeping all their options open as they await a governmental ruling on videodisc standards. There are some who feel that the optical system will get the go-ahead as an institutional-industrial-educational and advanced consumer system, and a simpler technique will be designated for the mass market.

**Heath joins Zenith:** Zenith, one of America’s “Big Two” television set manufacturers, is entering the small computer and consumer kit field through its recent purchase of the Heath Company. As soon as the merger was consummated, Zenith established a Data Systems Division, charged with developing Zenith-brand microcomputer products and systems in the small computer field for homes and businesses. The Zenith line will be marketed through Zenith dealers, retail computer stores and through Heath Electronic Centers and the Heath catalog. Of course, the entire Heath line will be continued and augmented under its new ownership.

Zenith has already been in the computer component field through manufacture of color monitors for Texas Instruments’ new small computer. Other consumer electronics makers are eyeing computers, too. RCA’s Solid-State Division has been manufacturing small computers for two years. GTE Sylvania will market the Mattel Intellivision video game, which is convertible to a computer. Magnavox’s Odyssey line, now equipped with alphanumeric keyboard, is beginning to look suspiciously like a series of products that can easily be converted to a computer.

**FCC on videoplayers:** The FCC has modified its policy on interference so as not to discourage the growing home video field. The Commission has proposed to make it easier for manufacturers to comply with interference rules for videocassette recorders and videodisc players. It proposes to eliminate the necessity for FCC testing of such products, and to permit a fairly large increase in RF radiation from them. This, says Commission staffers, is a calculated decision. One member put it this way: “We now feel we have the responsibility to protect the neighbors of people using these devices, but not reception within the same residence.”

This is the same rationale that led to the FCC’s adoption of a rule permitting the use of stand-alone RF modulators as intermediaries between home computers and TV sets (*Radio-Electronics*, December 1979). R-E

DAVE LACHENBRUCH  
CONTRIBUTING EDITOR

# Facts from Fluke on low-





# low-cost digital multimeters.

When you're looking for genuine value in a low-cost DMM you have a lot more to consider than price. You need information about ruggedness, reliability and ease of operation. Accuracy is important. And so are special measurement capabilities. But above all, you must consider the source, and that company's reputation for service and support.

Fact is, as electronics become more a part of our daily lives, dozens of new manufacturers are rushing to market their "new" DMM's. In theory, this is healthy; but in practice, crowding is confusion.

To help you deal with this flood of new products, here are some facts you should know about low-cost DMM's.

## The economics of endurance.

Even the least expensive DMM isn't disposable. Accidents happen, and test instruments should be built to take the abuses of life as we live it.

Look for a DMM with a low parts count for reliability, and rugged internal construction protected by a high-impact shell. Make sure the unit meets severe military tests for shock and vibration.

Another feature to check out is protection against overloading, whether from unexpected inputs, transients, or human errors.

Just for the record, all Fluke low-cost DMM's meet or exceed military specs, and feature extensive overload protection.

## The importance of being honest.

Just because a multimeter is digital doesn't mean it's automatically more accurate than a VOM — even though the LCD might give you that impression. The benchmark for accuracy in DMM's is basic dc accuracy. The specs will list it as a percentage of the reading for various dc voltage ranges.

Of course accuracy is more critical in some applications than others, and increasing precision and resolution in a DMM usually means increasing price. In the Fluke line, you can choose a model with a basic accuracy of 0.25% (the 8022A), others rated at 0.1%, or the new 8050A bench/portable at 0.03%.

## Special measurements: getting more from your DMM.

Actually, for all the variations in size, shape and semantics, most DMM's perform five basic measurements: ac and dc voltage and current, and resistance. Prices vary according to the number of ranges and functions a DMM delivers.

PRODUCT	FUNCTIONS	RANGES	DIGITS	BASIC DC ACCURACY	CONDUCTANCE	OTHER SPECIAL FEATURES	U.S. PRICE
8022A	6	24	3½	0.25%		Basic six-function DMM; lowest priced	\$129
8020A	7	26	3½	0.1%	X	High accuracy; Pioneer in conductance; exclusive two year warranty.	\$169
8024A	9	26	3½	0.1%	X	Direct temperature readings; continuity/ input level detector with selectable audible signal; peak hold capability.	Available soon
8010A	7	31	3½	0.1%	X	True RMS; extra 10A range.	\$239
8012A	7	31	3½	0.1%	X	True RMS; two extra low resistance ranges.	\$299
8050A	9	39	4½	0.03%	X	True RMS; selectable reference impedances with direct readouts in dBm; offset feature.	\$329

The Fluke line includes DMM's with from 24 to 39 ranges, 3½ and 4½-digit resolution, and some unique functions you won't find in any other DMM. Additional measurement capabilities like temperature, dB, conductance and circuit level detection.

If your work involves temperature measurements, the new 8024A delivers direct temperature readings via any K-type thermocouple. This is especially useful in testing component heat rise and checking refrigeration systems.

Another talented instrument is our new 8050A bench/portable. The micro-processor-based 8050A features a self-calculating dB mode in which dBm readings are displayed automatically referenced to one of 16 selectable impedance ranges — a real timesaver when servicing audio equipment.

And of course no discussion of DMM's is complete without considering conductance — a Fluke exclusive featured on five of our low-cost DMM's — which allows you to make accurate resistance measurements to 100,000 Megohms. You can't do that with any ordinary multimeter, but it's a must for checking leakage in capacitors and measuring transistor gain.

## A handful of efficiency.

When every minute matters, your schedule is tight and so is your work space, you need a portable DMM that's fast and easy to operate. We designed our handheld DMM's with color-coded in-line pushbuttons for true one-hand operation: no need to hang onto the meter with one hand while twisting a

rotary dial with the other.

But there's more to convenience than fingertip control. The 8024A, for example, is also designed to function as an instant continuity tester, with a selectable audio tone to indicate shorts or opens. It also has a peak hold feature to capture transients.

## A word about warranties.

Last but not least, look closely at the company that manufactures a low-cost DMM. Their service is just as important as their product. Look for no-nonsense warranties, a large family of accessories, an established network of service centers and technical experts you can rely on.

That's how you'll recognize a knowledgeable supplier of low-cost DMM's, a company with experience, resources and a commitment to leadership in the industry.

Incidentally, you'll find it all at Fluke.

Look for more facts from Fluke in future issues of this publication. Or call toll free 800-426-0361; use the coupon below; or contact your Fluke stocking distributor, sales office or representative.

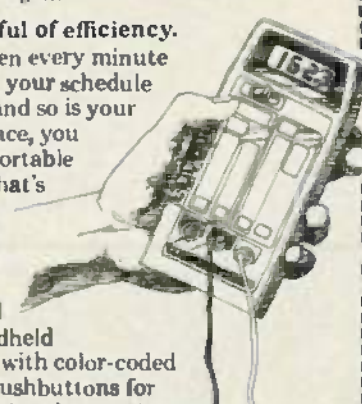
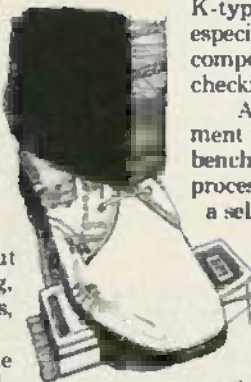

IN THE U.S. AND NON-EUROPEAN COUNTRIES:  
John Fluke Mfg. Co., Inc.  
P.O. Box 43210 MS-2B  
Mountlake Terrace, WA 98043  
(206) 774-2481  
Telex: 32-0013

IN EUROPE:  
Fluke (Holland) B.V.  
P.O. Box 5053, 5004 EB  
Tilburg, The Netherlands  
(0131) 673 973  
Telex: 52237

- Please send the facts on Fluke low-cost DMM's — specifications, applications information, and selection considerations.
- Please have a salesman call.

Name \_\_\_\_\_

Title \_\_\_\_\_ Mail Stop \_\_\_\_\_

Company \_\_\_\_\_

Address \_\_\_\_\_

City \_\_\_\_\_ State \_\_\_\_\_ Zip \_\_\_\_\_

Telephone ( ) \_\_\_\_\_ Ext. \_\_\_\_\_

For literature circle no. 34 RE 1/80

# Microcomputers are here! Get in on the ground floor with NRI's new "at home" training in computer technology.

Only NRI Gives You "Hands-on" Experience as You Build Your Own  
Designed-for-learning Microcomputer

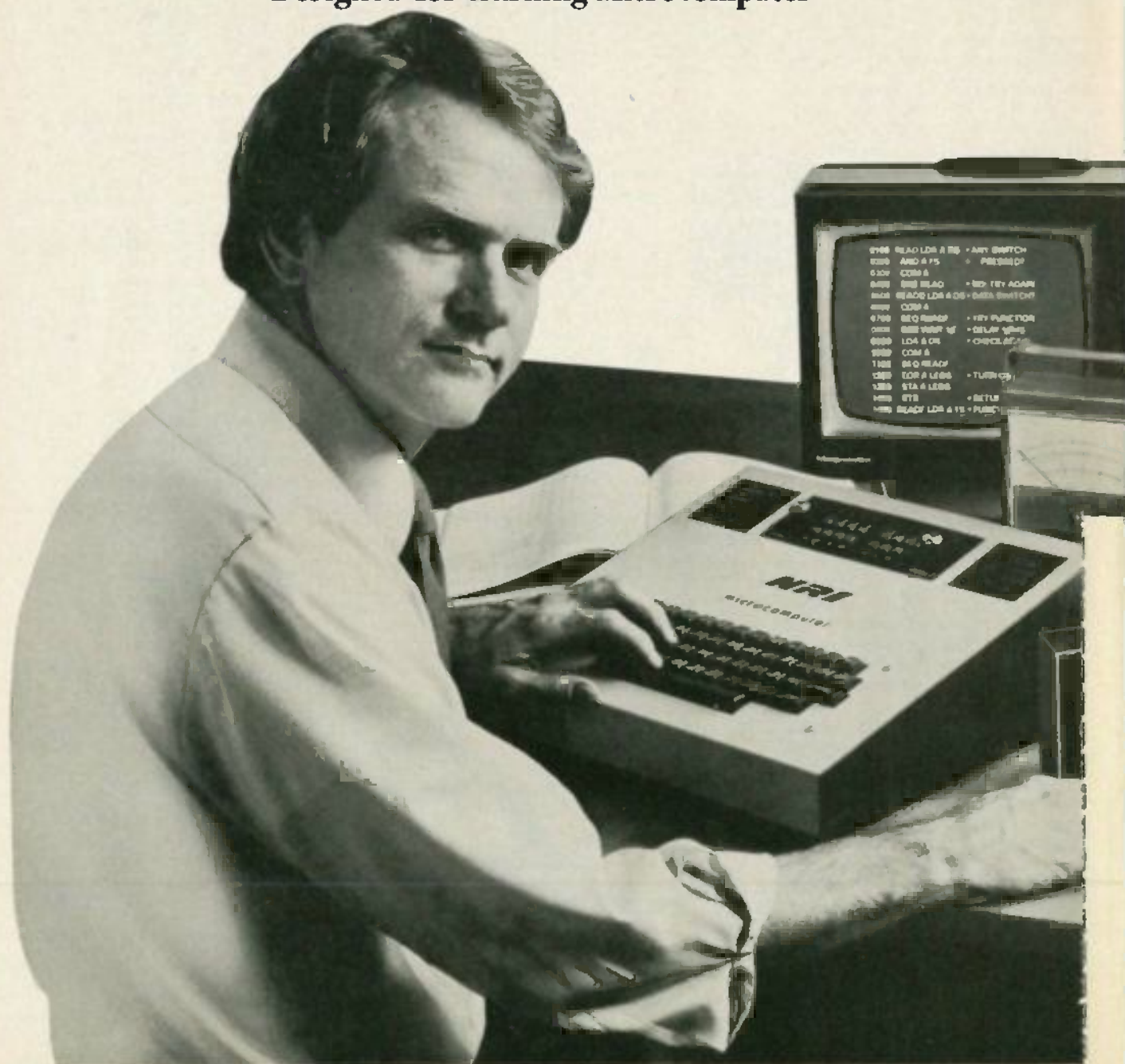

The microprocessor, that amazing little chip which shrinks electronic circuitry to microscopic size, has changed the world of the computer with dramatic speed. Now, big-performance computers are here in compact sizes...priced to make them practical for thousands of medium and small businesses, even homeowners and hobbyists.

Microcomputers are already being put to work on jobs like inventory control, payrolls, cost analysis, billing, and more. In homes, they're able to handle budgets and tax records, control environmental systems, index recipes, even play sophisticated games. And hobbyists across the country are expanding the state of the art while developing their own programs.

**Become a Part of This Incredible World ...  
Learn at Home  
in Your Spare Time**

NRI can give you the training and background you need for this exciting new science. Microcomputers require a new discipline, a broader viewpoint...the ability to think in both hardware and software terms. And NRI's new course in computer technology is geared to bridge the gap.

You get a firm foundation of digital theory while you get



practical, "hands-on" experience working with the NRI Discovery Lab,<sup>®</sup> assembling test instruments you keep, and even building your own fully-functional microcomputer.

Best of all, you do it at your own convenience. You learn at home with clearly written, "bite-size" lessons that carry you through the course in logical progression. There's no need to go to night school or quit your job...you progress at the pace that's most comfortable to you, backed by your personal NRI instructor and individual counseling whenever you want it.

**Assemble an Advanced Microcomputer with Exclusive Designed-for-Learning Features**

Only NRI trains you with a microcomputer that's specifically designed to teach you important principles as you build it. This state-of-the-art unit performs every function of comparable commercial units, has capabilities well beyond many. But each step of construction provides specific training, reinforces theory to make it come alive. And once you've finished, your microcomputer is ready to go to work for you. Or you can even sell it commercially.

You also assemble professional test instruments for use in your training. You get your own CMOS digital frequency counter and transistorized volt-ohm meter to keep and use in diagnosing problems and servicing computers. Together with up-to-the-minute lessons and NRI's 60-plus years of home study experience, you get the most in training and value.

**Other Courses in Today's Electronics**

Even the servicing of home entertainment equipment has taken quantum jumps forward. NRI keeps you right up with the latest, with training in stereo, video tape and disc players, and the latest TVs. You even build your own 25" diagonal color TV, the only one complete with built-in digital clock, varactor tuning, and computer control that lets you program an entire evening's entertainment. In our complete communications course, you learn to service two-way radio, microwave transmitters, radar, AM and FM transmitters, CB radio, paging equipment, and more. And you build your own 2-meter transceiver or 40-channel CB while you learn.

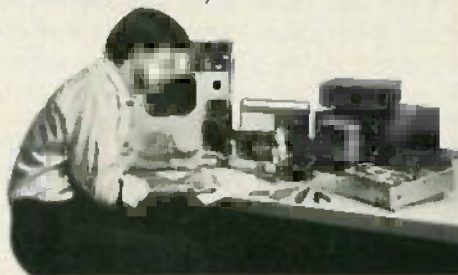

**Free 100-Page Catalog No Salesman Will Call**

Send the postage-paid card today for your personal copy of the NRI electronics course catalog. It shows all the equipment, training kits, and complete lesson plans for these and many other courses. There's no obligation of any kind and no salesman will ever bother you. Find out how you can learn new skills, keep up with technology, advance your future with training for new opportunities. Get in on the ground floor now! If card has been removed, write to:



**NRI Schools**  
McGraw-Hill Continuing  
Education Center  
3939 Wisconsin Ave.  
Washington, D.C. 20016



## A New Decade

The decade of the 70's has come to a close, and the decade of the 80's has begun. The new electronics decade, however, is already under way and is going full blast. To get a feel for the latest technology and what the 80's will hold in store for us, let's glance at some of the happenings and some of the terms and acronyms that are presently being used in the semiconductor industry—the foundation upon which tomorrow's electronics industry is built.

Do you remember when C-MOS (complementary-MOS) was the greatest thing to happen since the invention of the light bulb? Now there's also n-MOS (N-channel MOS). This logic family has several different names, depending on who is doing the manufacturing. They include HMOS, X-MOS and S-MOS. The HMOS (high-performance n-MOS) family also has a sister (brother?) called HMOS II. On top of this, Advanced Micro Devices has a scaled-down MOS process called PolyPlanar. How about a P<sup>2</sup>C-MOS which is a double-polysilicon process! Other logic families around include ISL (Injection Schottky Logic), STL (Schottky Transistor Logic), Isoplanar-S, and even BEST (Basic-Emitter Self-Aligned Technology). Manufacturers even mix technologies within the same IC. Matsushita has an IC that combines p-channel MOS with I<sup>2</sup>L and ion-implanted NPN transistors. One last one: we've all heard about MOSFET's, but how about a MESFET (Metal Semiconductor Field Effect Transistor).

Where is all this technology leading us? Not long ago, the jump from 4K to 16K RAM's opened many new doors. Today, semiconductor manufacturers have introduced 64K RAM's. Bubble memories were introduced in the 70's with a capacity of 256K. Two bubble memory devices were introduced in 1978, each with a capacity of 1 megabit. Now manufacturers are talking of 8-megabit capacities per device within the next few years.

Microprocessors have also come a long way. From the original 4004, through the 8008, 8080 and Z-80, we now have the Z-8000. It is a 16-bit processor that has many 32-bit attributes. In other words, it behaves like a 32-bit processor in many ways. There are also the 68000 and NS16000, both 16-bit processors. Many, many processors have been introduced, and if I were to list them, they would fill several more paragraphs. One introduction however, cannot go without mention, the analog microprocessor. Intel's 2920 is a digital microprocessor that includes D/A and A/D converters on the input and output ports. It's a digital processor that connects to analog signals.

Remember SSI (Small Scale Integration) and MSI (Medium Scale Integration)? We're now working with LSI (Large Scale Integration) but the push is on for VLSI (Very Large Scale Integration). Oh well, I remember working with RTL (Resistor Transistor Logic) and DTL (Diode Transistor Logic). I wonder what we'll be using in 1990?



ART KLEIMAN  
MANAGING EDITOR

Hugo Gernsback (1884-1967) founder  
M. Harvey Gernsback, editor-in-chief and publisher  
Larry Steckler, CET, editor  
Arthur Kleiman, managing editor  
Robert F. Scott, CET, W2PWG, technical editor  
Jack Darr, CET service editor  
Leonard Feldman contributing high-fidelity editor  
Karl Sevon, semiconductor editor  
Herb Friedman, communications editor  
David Lachenbruch, contributing editor  
Earl "Doc" Savage, K4SDS, hobby editor  
Ruby Yee, production manager  
Robert A. W. Lowndes, production associate  
Marie J. Stolfi, production assistant  
Gabriele Margules, circulation director  
Arline R. Fishman, advertising coordinator

Cover design by Louis G. Rubsam  
Cover photo by Robert Lewis

Radio Electronics is a member of the *Institute of High Fidelity* and is indexed in *Applied Science & Technology Index* and *Readers Guide to Periodical Literature*.

Gernsback Publications, Inc.  
200 Park Ave. S., New York, NY 10003  
(212) 777-6400  
President: M. Harvey Gernsback  
Vice President: Larry Steckler  
Secretary/Treasurer: Carol A. Gernsback

### ADVERTISING SALES

Paul McGinnis  
Director of Marketing

### EAST

Stanley Levitan  
Radio-Electronics  
200 Park Ave. South  
New York, NY 10003  
(212) 777-6400

### MIDWEST/Texas/Arkansas/Okla.

Ralph Bergen  
The Ralph Bergen Co.  
540 Frontage Road—Suite 361-A  
Northfield, Illinois 60093  
(312) 446-1444

### PACIFIC COAST

Mountain States  
Jay Eisenberg  
J.E. Publishers Representative Co.,  
8732 Sunset Blvd.,  
4th Floor,  
Los Angeles, CA 90069  
(213) 659-3810  
Sales Mart Building  
1485 Bayshore Blvd., Box 140  
San Francisco, CA 94124  
(415) 467-0125

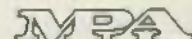

# The Protectors

The two products shown below are the latest in Space-Age Electronic Home Security. Do you know which one is right for you?



The GE Zonar Burglar Alarm is a Superior Fail-Safe unit that has an invisible ultrasonic beam to detect intruders.



The Micro FM Wireless Mike has a range of over 300 ft. and transmits through any standard FM Radio.

The two new products shown in this ad are the latest in space-age electronics. The Zonar Burglar Alarm compares with similar burglar alarms selling for \$200 or more. The Micro FM Wireless Mike, the worlds smallest wireless microphone, represents new technology in the field of FM Radio-Electronics.

We bought both of these products from the manufacturers and tested them under every possible condition. The following are the results of our experiments with both the Zonar Burglar Alarm and the Micro FM Wireless Mike. Please read on. The results may surprise you!

### THE GE ZONAR BURGLAR ALARM

The new GE Zonar Burglar Alarm sounds a loud (85db) alarm — so loud that it can cause pain — and scare away intruders that cross the invisible ultrasonic beam.

The Zonar Burglar Alarm requires no installation and it is portable, so you can place it anywhere in your home. Operating the Zonar is as easy as turning on your television. To arm the unit, you simply press the On Instant or On Delay button. You now have 35 seconds to leave your home. When you return, you enter and you have 10 seconds to press in your secret code numbers. This will disarm your unit. The personalized code numbers for alarm shut-off means that only you or your family knows the code to disarm the alarm.

The Zonar Burglar Alarm looks like a handsome piece of furniture and its small unobtrusive design helps to make it less noticeable. It measures only 7" X 4" X 3" and weighs less than two pounds. To help protect your home or office, it comes with warning decals for windows or doors that state, "WARNING Protected by Electronic Surveillance Equipment", to help deter potential burglars.

The GE Zonar Burglar Alarm is battery operated, so even if a burglar cuts off your power, the unit will still be operational to alert you and your neighbors.

The GE Zonar Burglar Alarm comes with

complete instructions and a One-Year limited warranty backed by General Electric. Should your unit ever malfunction, you may drop it off at any authorized General Electric Dealer or you may use GE's convenient service-by-mail center.

To order your unit for a 30-day test, simply send your check for \$69.95 plus \$2.50 postage and handling to Chandler's, One Chandler Plaza, Chantilly, Virginia 22021 (Virginia residents please add 4% sales tax.) Credit Card Buyers may call our 24-hour Toll-Free number below.

### THE MICRO FM WIRELESS MIKE

The micro FM Wireless Mike is a miniature microphone that picks up your voice and transmits it through any standard FM radio.

The new Micro FM Wireless Mike measures only 1 1/2" X 1/2" and weighs less than one ounce. We found that the superior electronic components put into the microphone surpass anything else on the market. It has a transmitting range of over 300 feet (the length of a football field) and its exceptional fidelity gives you clear reception with practically no interference. Unlike citizen band radios, which operate in the 27 to 29 Megahertz range, the Micro FM Wireless Mike uses the 88 to 108 Megahertz range, giving you the freedom to operate from your car radio, portable radio or home stereo.

**BUT WAIT, THERE'S MUCH MORE.** The Micro FM Wireless Mike is capable of more than just being a remote mike. It can be used as an intercom in both your home and office. For example, if you are in the garage and your wife or children are in the upstairs bedroom, you can turn on the mike and use it just like an intercom. Secondly, it is small and can be clipped to your jacket while in meetings or during a speech in your conference room or office. The Micro FM Wireless Mike is FCC approved for use in homes, apartments, offices or factories.

Finally, it's inexpensive — only \$29.95 complete with 27" flexible antenna, carrying case, operating instructions and a fresh 1.3 volt

mercury battery (which can be replaced at any hearing aid or radio-electronics store).

Your Micro Mike comes with a 90 day limited warranty backed by two substantial companies. Should a malfunction ever occur, there's a complete service-by-mail center as close as your postman.

The Micro FM Wireless Mike can be ordered by calling our 24-hour toll-free number below or by sending your check for \$29.95 for one or \$58.00 for two. Please add \$1.25 each for postage and handling and Virginia residents add 4% sales tax.

### OUR OPINION

We are convinced that both of these new products are superior in value and quality.

The Micro FM Wireless Mike and the GE Zonar Burglar Alarm are backed by two substantial American companies. MLI Industries and General Electric both have years of experience in manufacturing and design leadership. Chandler's is one of America's innovative companies specializing in bringing the American public new and unique products — additional assurance that your prudent investment is well secured.

With any Chandler's product, you may return it within 30 days for a full, courteous and prompt refund with positively no questions asked and we even refund our postage and handling charge. There's no risk when you can own the best. Order one or both of our remarkable new products, at no obligation today.

## Chandler's

Innovative Products

Dept. ZZ One Chandler Plaza, Box 137  
Chantilly, Virginia 22021 (703) 631-2024  
**CALL TOLL-FREE... 800-638-1287**  
**In Maryland Call... 800-492-1275**  
ASK FOR OPERATOR #1091

Chandler's, Inc. © 1979

# what's news

## Second satellite seminar scheduled for Miami

Following the highly successful satellite seminar held at Oklahoma City last August, a second one will be held in Miami, February 5, 6, and 7. The three-day program will include more than two dozen technology lecture sessions by three authorities on satellite technology, as well as special sessions on marketing and selling low-cost satellite terminals.

The cost of the three-day seminar is \$150. Pre-registration is mandatory. Because a large number had to be turned away at Oklahoma City, where 506 attended, facilities for a thousand or more are being obtained at Miami. Full information is available from Satellite Television Technology, P.O. Box G., Arcadia, OK (phone 405-396-2574).

## Olympic ski communications to get power from the sun

The 1980 Winter Olympics command post (Lake Placid, NY) and the top of 4,867-foot Whiteface Mountain, on which the ski events take place, will be linked by a communications system powered in part by 20 photovoltaic solar panels. Each of these panels consists of 36 three-inch single-crystal silicon cells in a weatherproof assembly. Power output of each panel averages 1.2 amperes at 16.2 volts (approximately 20 watts of peak power).

There will be two primary links and one standby system for communication between the peak of Whiteface Mountain and the base camp below. The first, a wired system, consists of 12 semi-portable telephones between the peak and base of the mountain. The second system, which acts as an intercom, uses a dozen fixed-position telephones. The standby system works with a General Electric UHF radio.

All the systems can be powered by the group of 20 large panels. Eight panels of an 18-panel array on the roof of White Mountain Ski Lodge supply 2.4 amperes at 48 volts for the first race communications system; the remaining ten can provide 6 amperes at 10 volts for the second, electrically independent intercom setup.

A two-panel array powers the emergency standby system and charges a bank of storage cells. Should the regular electric power fail completely, it will be able to supply energy for all the communications systems, as well as the lighting required for the games, for as long as two hours.

## New evaporated recording tape increases density ten times

A recording tape in which the magnetic recording layer is evaporated directly onto the base film surface has a density ten times that of conventional tape. States its developer, Matsushita Electric Industrial Co. This means that a 3-hour tape for

microcassette recorders can be made. The new tape, called Angrom, was scheduled for test marketing in Japan this fall. No plans for export were announced.

In all ordinary tapes (including "metal" tapes) the magnetic material is mixed with resins in about a 30:70 ratio. Only 30% of the surface is actual magnetic material. The surface of the new tape is 100% magnetic. Because the adhesive material is not needed, the coating is thinner—0.3 micron instead of the usual 3 microns. This reduces bulk, making it possible to put a longer tape in a given cassette. The all-magnetic surface will record shorter waves, thus high-frequency response is improved.

The new tape was made possible by overcoming production problems in connection with applying the coating and securing its adhesion to the film base.

## American scientists, German machine head search for newest particle

The elusive particle that is believed to hold all matter together—the whimsically named gluon—was discovered by a research team headed by University of Wisconsin physicist Sau Lan Wu, aided by Georg N. Sobering, the University of Wisconsin—Madison reports. The team spent the last two years at Hamburg, working with the new electron accelerator (which is known by its German acronym PETRA), to observe events following collisions between high-energy electrons and oppositely charged positrons.

When high-energy electrons and positrons collide they convert all their energy and mass into an energy bundle called a virtual photon. From that energy bundle a quark and an antiquark are produced. These move apart in opposite directions. This causes the quark and antiquark to form a stream of particles in a narrow cone, called a jet.

One jet is formed from each of the original quark and antiquark that are produced from the virtual photon. If the energies of the colliding electrons and positrons are high enough (in this case 15 billion volts each) then one of the quark jets can radiate a gluon, which also turns into a jet of particles.

Using a method devised by Drs. Wu and Sobering, the research team developed a computer program to analyze the data from the electron-positron annihilations, and the third jet—evidence for the gluon—was discovered. "If the 3-jet events we detected are not from the gluon," Dr. Wu told the conference in Geneva, Switzerland, last June, at which the information was first presented, "then something very

*continued on page 16*



10 PANEL SOLAR ARRAY being installed on the roof of Whiteface Mountain Ski Lodge by Arthur Rudin (left) of Arco Solar, Inc., and Ronald Stewart of the State University of New York, in a project coordinated by the Northeast Solar Energy Center of Cambridge, MA. The solar array will provide power to communications systems for downhill ski events at the 1980 Winter Olympics.

# Sabtronics NEW Hand-held Digital Multimeters . . .

## The only thing that beats their performance is their price.

Accurate performance you can rely on, time after time. That's what you expect from a quality DMM. But don't expect to pay as much for it any more. Because now Sabtronics brings you top quality DMMs with more features and better accuracy than other comparable units on the market today. And they cost surprisingly less!

**We cut the price.  
Not the quality.**

What you get is a precision crafted unit that features single-chip LSI logic, laser trimmed resistor network and a stable band-gap reference element for better long term accuracy. Basic DCV accuracy is 0.1%. The Model 2035A gives you 32 measurement ranges over 6 functions and the Model 2037A an additional two temperature ranges.

**First in features.  
First in price.**

Both models feature touch-and-hold capability with the optional probe — its so convenient, you'll wonder why the expensive models haven't got it yet! And two-terminal input for all measurement functions — this eliminates lead switching and makes your job easier. The Model 2037A even has a built-in temperature measuring circuit with a  $-50^{\circ}\text{C}$  to  $+150^{\circ}\text{C}$  range ( $-58^{\circ}\text{F}$  to  $+302^{\circ}\text{F}$ ) and is supplied complete with the sensor

probe. Of course, auto zero, auto polarity and overload protection are standard. And you get 200 hour operation from a single 9V transistor battery. A low battery indicator warns you of the last 20% of battery life. The large, crisp LCD readouts allow easy viewing even in bright sunlight.

Assembling either kit is simple with our easy-to-follow, step-by-step instructions. And the built-in calibration references allow you to calibrate the unit any time, any place.

We've even eliminated difficult inter-connect wires. All parts mount on the PC board. The only wires you solder are the two battery-snap leads.

**Biggest value in small DMMs**

To sell hand-held DMMs with all these features at such low prices, we had to sacrifice profits. But we never sacrificed quality or performance. We are so sure that the Model 2035A and 2037A are the best values available that we offer a money-back guarantee. Examine either unit in your own home for 10 days, and if you are not convinced that it is the best value for your money, return it in its original condition for a prompt

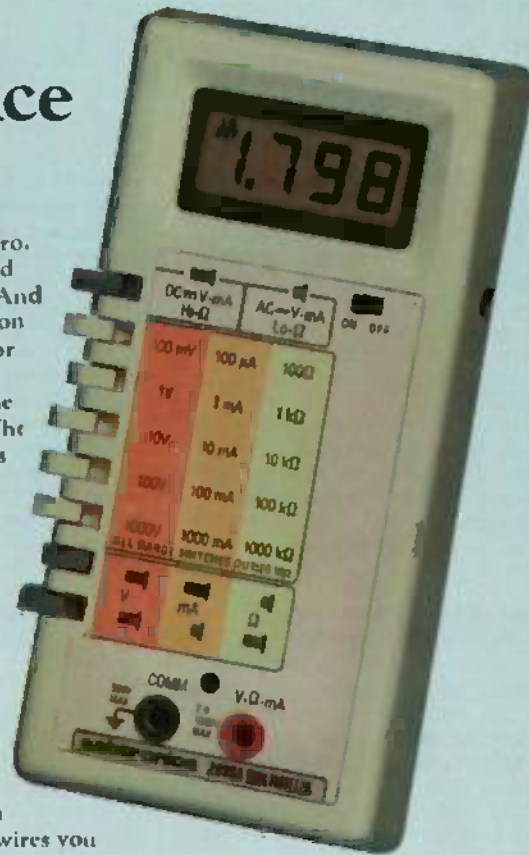

and courteous refund of the purchase price (less shipping and handling). Order yours today! Use the convenient order form or call us with your Master Charge or Visa number.

*Making Performance Affordable*

**sabtronics**   
INTERNATIONAL INC.

13426 Floyd Circle M/S 35 - Dallas Texas 75243  
Telephone 214/783-0994

### BRIEF SPECIFICATIONS:

DC VOLTS: 100 $\mu$ V - 1000V, 5 ranges  
AC VOLTS: 100 $\mu$ V - 1000V, 5 ranges  
DC CURRENT: 0.1 $\mu$ A - 2A, 5 ranges  
AC CURRENT: 0.1 $\mu$ A - 2A, 5 ranges  
HI-OHMS: 0.1 $\Omega$  - 20M $\Omega$ , 6 ranges  
Lo-OHMS: 0.1 $\Omega$  - 20M $\Omega$ , 6 ranges  
TEMPERATURE:  $-50^{\circ}\text{C}$  -  $+150^{\circ}\text{C}$   
( $-58^{\circ}\text{F}$  -  $+302^{\circ}\text{F}$ ), 2 ranges  
(Model 2037A only).

WEIGHT 11 oz (excl battery)

OVERLOAD PROTECTION, 1000V DC or AC peak all voltage ranges, 250V DC or AC peak all Ohms ranges, 2A/250V fuse all current ranges.

Mail to: Sabtronics International, Inc., 13426 Floyd Circle, M/S 35, Dallas, Tx 75243.

Please send me . . .

_____ Model 2035A Hand-held Multimeter kit(\$)	@ \$74.95 each	_____ \$
_____ Model 2035A Hand-held Multimeter assembled	@ \$99.95 each	_____ \$
_____ Model 2037A Hand-held Multimeter kit(\$)	@ \$89.95 each	_____ \$
_____ Model 2037A Hand-held Multimeter assembled	@ \$119.95 each	_____ \$
_____ #THP-20 Touch-and-hold Probes	@ \$19.95	_____ \$
_____ Shipping and Handling	@ \$5.00 per instrument*	_____ \$

For delivery in Texas, add 5% Sales Tax

Enclose  check  money order  Master Charge  Visa  **TOTAL** . . . \$

(Allow 2-3 weeks clearance time for personal checks, 10% deposit for C.O.D.)

Charge my credit card \$ \_\_\_\_\_ Expiry Date \_\_\_\_\_

Name \_\_\_\_\_

Street \_\_\_\_\_ Apt. \_\_\_\_\_

City \_\_\_\_\_ State \_\_\_\_\_ Zip \_\_\_\_\_

\*Continental U.S. only, AK, HI & PR: \$6.00, Canada: \$7.50, Foreign: \$19.00 Airmail.

# what's news

continued from page 14

exciting is just around the corner."

Why is the gluon so important to physicists? Scientists since Einstein have proposed the existence of four forces, electromagnetic, gravitational, strong, and weak, each of which has elementary carriers of force. The photon is the carrier of force of electromagnetism and until now it was the only one known.

The existence of the gluon, the carrier for the strong force, is encouraging to physicists who are seeking the carriers of the gravitational and weak forces. It is the hope of many physicists to eventually combine all four forces into one grand unified theory of matter.

## Marriage of sound and print in new audio-visual system

What the manufacturer, Microsonics Corp, calls a "totally new dimension in publishing" has just been introduced. It consists of a miniature handheld player, called a "Microphonograph" and a 2-inch transparent record that can be applied direct to a page of a book or to a card designed for the purpose. The record plays for a minute and a half.



HOW THE MICROPHONOGRAPH is used. The device adds sound to the information obtainable from a printed book.

The user simply places the Microphonograph on the page, locates the record and presses the "play" button. Instantly he has his own multimedia system, combining pictures, print and sound.

The system would seem especially valuable in the language field, giving even a home student practically the services of a native-speaking teacher. In other subjects the added sound can make a dry text come

alive, with the author's voice commenting on the texts (in historical or biographical works, often with the voice of the subject). Special formats for combining sight and sound in training courses are already being produced by several firms.

In the card format, one side can display photos, maps or diagrams that will complement information on the record, and the back can carry additional information or instructions. The system can even be adapted to existing printed material, making it one of the least expensive of audio-visual systems.

The system—Microphonograph and records—is priced from \$20 up, depending on the choice of hardware and quality and quantity of software. Updating or extending is easy, simply by adding new microrecords and cards.

## Lights three times as good are forecast for year 2000

A research study just conducted by Westinghouse Electric scientists concludes that—while electric costs will triple by the year 2000—improvements in lighting will mean that the lighting part of the average user's bill will rise only slightly.

High-intensity mercury vapor, metal halide and high-pressure sodium vapor discharge lamps—already in use in industry—will make great energy savings in residential lighting. Up to 150-175 lumens per watt is attainable with such lamps, the Westinghouse scientists predict. (Standard bulbs in use today have an efficiency of only 15-20 lumens per watt—a 100-watt bulb is rated at 1710 lumens.)

The average homeowner, the study found, pays \$57 per year, or 27 percent of his total electric bill, for lighting. By the year 2000, this should decrease to about 8 percent. But—the new light bulbs will cost more, maybe \$5 to \$15 each. The cost of lighting will have to be calculated on the price of the bulb together with the amount of light it will give in its useful lifetime.

The fluorescent lamp—already at least four times as efficient as the tungsten bulb—will take over in the home, through color improvement and new design. Already screw-in types are being made to use in existing incandescent fittings.

Further new developments are predicted: Lighting will be used for home security; proximity sensors installed around the perimeter of a residence and activated by an intruder will turn on the inside lighting. New products will improve perception, reduce eyestrain and satisfy specific health requirements. Special lighting will be introduced for older people. A major area of research will be devoted to the psychological, behavioral and physiological effects of lighting on people.

## Students do original research in summer training session

A near-unique type of industrial "student training" program is being cosponsored by GTE Laboratories and the National Science Foundation. Some 40 students, representing 19 colleges and universities, are participating in research projects at GTE facilities.

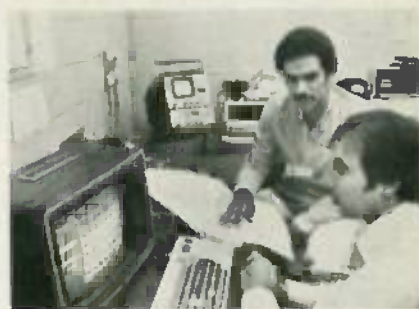

ALFREDO ARCHILLA, of the university of Puerto Rico, working with GTE staffer William Hertz on his "smart telephone" project.

Unlike many "student training" programs, this one provides the student with genuine research and real work. If they succeed in their tasks, they have the realization that they have added to the world's knowledge, technology or convenience.

For example, Alfredo Archilla of the University of Puerto Rico at Mayaguez, is working on a "smart telephone" that will not only accept voice commands but will talk back. "Right now," says Mr. Archilla, "you can tell a telephone to perform a task in your home (such as turning the oven on or off) from a remote location by touch tone. When you ask it it has finished the job, it also answers in tone. We want it to answer in words, and my job is to develop such a program."

## Subscription TV stations now permitted to proliferate

The FCC voted, in a meeting late in September, to rescind the rule that permitted only one pay-TV station in a community.

The opposition to subscription television by broadcasters and movie theaters that was so marked when pay-TV was first proposed has decreased to only token opposition, FCC sources reported. It is possible that the extensive development of cable television has reduced the relative importance of over-the-air subscription systems.

There are at present only six pay-TV stations on the air. The largest, KBSC, Corona, CA, which serves the Los Angeles region, has 210,000 subscribers. The others are KNOV in Phoenix, AZ; KWHY, Los Angeles, CA; WQTV, Boston, MA; WWHT, Newark, NJ, and WXON, Detroit, MI. R-E



# Sabtronics new counter gives you 600 MHz capability for only \$89.95



This highly accurate frequency counter can be yours at the unbelievably low price of \$89.95. The Sabtronics 8610A is your best buy today in a lab-quality instrument.

We spent our efforts where they count: applying Sabtronics' advanced digital technology in the design and engineering of a superior frequency counter — in simple kit form.

#### You count your savings:

You spend a little time (and a lot less

#### BRIEF SPECIFICATIONS

- Frequency Range: 10 Hz to 600 MHz guaranteed (5 Hz to 750 MHz typical).
- Sensitivity:  $\leq 10$  mV RMS, 10 Hz to 100 MHz, prescaler mode; 50 mV RMS, 100 MHz to 450 MHz; 70 mV RMS, 450 MHz to 600 MHz.
- Impedance: 1 M $\Omega$ , 10 MHz & 100 MHz range; 50 $\Omega$ , 600 MHz.
- Temperature Stability: 0.1 ppm/ $^{\circ}$ C.
- Gate Time: Switch-selectable, 0.1 sec., 1 sec., 10 sec.
- Ageing Rate:  $\leq \pm 5$  ppm/yr.
- Accuracy: 1 ppm + 1 digit.
- Input Protection: 150 V RMS, 5 Hz to 10 kHz; 90 V RMS, 10 kHz to 2 MHz; 30 V RMS, 2 MHz to 100 MHz; 10 V RMS, 100 MHz to 750 MHz.
- Power Requirement: Battery-operated, 4.5 to 6.5 VDC @ 300 mA. External power supply, 7.5 to 9 VDC @ 300 mA.
- Size: 8"W x 6.5"D x 3"H (203 x 165 x 76 mm).
- Weight: Without batteries, 1.2 lbs. (0.54 kg).

money!) for a compact bench-portable counter that measures up to 600MHz (typically even higher).

#### Measures up on every count:

It has what you want. Guaranteed from 10Hz to 600MHz in three ranges (typically 5Hz to 750MHz). Sensitivity that holds well over the entire range. Selectable gate time for optimum resolution: 0.1, 1, or 10 seconds. With a stability of 0.1 ppm/ $^{\circ}$ C. And the guaranteed frequency range has a measurement accuracy of 1 ppm + 1 digit -0.0001%.

Highly accurate time base and excellent ageing rate. 8-digit LED display with automatic decimal point placement, leading zero suppression and overflow indicator.

Start counting the day you receive it: You can assemble your 8610A in an evening with our easy-to-follow, step-by-step instruction manual.

Count on satisfaction: Keep our kit for 10 days' free trial examination. If you're not completely satisfied for any reason whatsoever, simply return it unassembled for a prompt and courteous refund of your purchase price.

Making Performance Affordable

**sabtronics** INTERNATIONAL INC.

13426 Floyd Circle M/S 35 Dallas, Texas 75243  
Telephone 214/783-0994

To: Sabtronics International, Inc. 13426 Floyd Cr., M/S 35, Dallas, TX 75243 USA

Please send me \_\_\_\_\_ Model 8610A

Frequency Counter Kits @ \$89.95 ea.

\$ \_\_\_\_\_

Shipping & handling, per kit, \$8.00\*

\$ \_\_\_\_\_

Texas residents add 5% sales tax

\$ \_\_\_\_\_

Total enclosed

\$ \_\_\_\_\_

I enclose  check  money order. (For faster delivery, send cashier's check or money order. Please allow time for personal checks to clear bank.)

Charge:  Visa  Master Charge.

Account No. \_\_\_\_\_

Exp. Date \_\_\_\_\_

Name \_\_\_\_\_

Address \_\_\_\_\_

City \_\_\_\_\_

State \_\_\_\_\_

Zip \_\_\_\_\_

\*US only, Canada: \$7.50, Foreign, air mail, \$21.00.

# If you have put off learning more electronics for any of these reasons, act now!

- I don't have the time.
- High school was hard for me and electronics sounds like it may be hard to learn.
- I can't afford any more education.
- I have a family now.
- I'm here. You're there. I've never learned that way before. I'm not sure it will work for me.

**Read the opposite page and see how you can get started today!**

**Be honest with yourself. Are the reasons really excuses? You already know enough about electronics to be interested in reading this magazine. So why not learn more? If you need encouragement, read on and see how excuses can be turned into results.**

**You don't have the time.** Be realistic. All you have in life is a period of time. Use it. Try to know more tomorrow than you do today. That's the proven way to success. CIE studies require just about 12 hours of your time a week, two hours a day. You probably do have the time.

**Electronics sounds like it may be hard to learn.** You already know something about electronics or you wouldn't be reading this. Now, build on that. CIE Auto-Programmed® Lessons help you learn. Topics are presented in simple, logical sequence. All text is clear and concise for quick, easy understanding. You learn step by step, at your own pace. No classes to attend. Nobody pressures you. You can learn.

**You can't afford any more education.** Actually, you can't afford NOT to gain the skills that can put you ahead of the others. You know what inflation is doing to you now. Education—learning a skill—is an inflation-fighter that can be yours. If you are not able to pay full tuition now, CIE will lend you funds on a monthly payment plan.

**You have a family now.** All the more reason why you have the responsibility to advance yourself. For the sake of your family. Do you want them to have what you had or have more than you had? The choice is yours. Electronics is a rewarding career choice. CIE can help you to get started on that career.

**You're there. We're here. How does CIE help you learn?** First, we want you to succeed. You may study at home, but you are not alone. When you have a question about a lesson, a postage stamp gets you your answer fast. You may find this even better than having a classroom teacher. CIE understands people need to learn at their own pace. When CIE receives your completed lesson before noon any day of the week, it will be graded and mailed back the same day with appropriate instructional help. Your satisfaction with your progress comes by return mail. That's how CIE helps you learn.

**NOW, IF YOU AGREE CIE TRAINING CAN WORK FOR YOU, HOW ELSE CAN CIE HELP YOU?**

Cleveland Institute of Electronics is the largest independent home study school in the world that specializes exclusively in electronics. Although "big" does not always mean "best," it is evidence that CIE is a strong, successful institution with the people and resources to help you succeed.



**Step-by-step learning includes "hands-on" training.** The kind of professional you want to be needs more than theory. That's why some of our courses include the Personal Training Laboratory, which helps you put lesson theory into actual practice. Other courses train you to use tools of the trade such as a 5MHz triggered-sweep, solid-state oscilloscope you build yourself—and use to practice troubleshooting. Or a beauty of a 19-inch diagonal Zenith solid-state color TV you use to perform actual service operations.



Pattern simulated

**Your FCC License can impress employers.** For some electronics jobs, you must have your FCC License. For others, employers usually consider it a mark in your favor. Either way, your License is government-certified proof of your knowledge and skills. More than half of CIE's courses prepare you to pass this exam. Surveys show that some 80% of CIE graduates who take the exam are successful.

**Find out more! Today. Now.** There's a card with this ad. Fill it in and return. If some other ambitious person has already removed it, use the coupon.

You'll get a copy of CIE's free school catalog, along with a complete package of personal home study information.

For your convenience, we'll try to arrange for a CIE representative to contact you to answer any questions you may have.

If you are serious about a rewarding career, about learning electronics or building on your present skills, your best bet is to go with the electronics specialists—CIE. Mail the card or



coupon today or write CIE (please mention the name and date of this magazine), 1776 East 17th Street, Cleveland, Ohio 44114.

This could be the best decision you've made all year.

**"If you're going to learn electronics, you might as well learn it right!"**

*John Cunningham  
Senior Technical Director*



**CIE Cleveland Institute of Electronics, Inc.**

1776 East 17th Street, Cleveland, Ohio 44114  
Accredited Member National Home Study Council

**YES...** I want to learn from the specialists in electronics—CIE. Send me my FREE CIE school catalog plus my FREE package of home study information. RE-79

Print Name \_\_\_\_\_

Address \_\_\_\_\_ Apt. \_\_\_\_\_

City \_\_\_\_\_

State \_\_\_\_\_ Zip \_\_\_\_\_

Age \_\_\_\_\_ Phone (area code) \_\_\_\_\_

Check box for G.I. Bill bulletin on Educational Benefits:  Veteran  Active Duty

**MAIL TODAY!**

# letters

## HEART RATE

I am a physician, currently in my fourth year of surgical residency. In addition, I hold a Masters Degree in Electrical Engineering. Because of my background, I am naturally fascinated by articles in your magazine relating to medical applications of electronics. Such an article was Mark C. Worley's "Heart Rate Monitor" (July 1979 issue). I must, however, take exception with several points in the author's description of the device's operation.

The "heart beat waveform" depicted in the article correctly shows a typical electrocardiogram tracing. This is a recording of the electrical activity measured between a pair of electrodes in contact with the skin of the body. It corresponds to the discharge and recovery of the electric charge across the membranes of heart muscle cells, which initiates contraction of the muscle.

The device, that is described in the article is commonly referred to as an optical plethysmograph (from the Greek plethysmos, an enlargement). It measures the minute expansion and contraction of the fingertip in response to the blood pressure

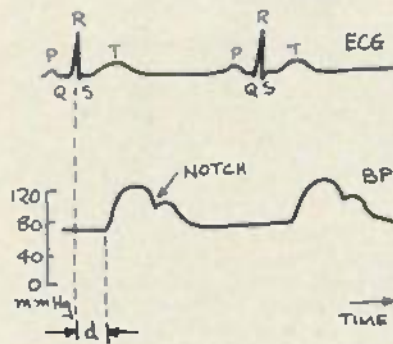

pulsations within its arteries. The enclosed diagram illustrates the relationship of the heart electrical activity (ECG, or electrocardiogram) and the blood pressure (BP). The R-wave, or more correctly the QRS complex, is the activity that initiates the contraction of the main pumping chambers. The T-wave is the activity that accompanies electrical recovery of the charge across the cell membranes.

The pressure tracing is characterized by

a sharp rise to peak (systolic) pressure, and a more gradual falloff to the (diastolic) pressure before the next contraction. The "notch" in the curve on its downslope is caused by the one way valve at the outlet of the heart snapping shut as the pressure falls. The delay,  $d$ , is a function of the response time of the muscle to the electrical stimulation, and the propagation delay of the pressure pulse down the artery.

From this discussion, it can be seen that prevention of multiple triggering is indeed necessary. However, Mr. Worley's statement "triggering on . . . R- and T-waves" is misleading.

Another inaccuracy contained in the article is the reference to the 300 ms (misprinted as 300  $\mu$ s) period of trigger lockout as a Schmitt trigger. A Schmitt trigger is a circuit that has hysteresis, i.e., a different threshold for positive-going and negative-going input changes.

Finally, it must be kept in mind that the heart rate may rise over 200 beats-per-minute under stress or after heavy exercise, and that in a young, well trained athlete the resting heart rate may be as low as

# "I prefer RCA SK's because they have the abilities:



STANLEY J. LYSY

Ready Availability  
Wide Interchangeability  
Excellent Identifiability  
and High Reliability.

All these add up to  
Good Profitability."

These are the words of Stanley J. Lysy  
of Service Plus, Westfield, Massachusetts.

35-40 beats-per-minute. Thus for some applications, it may be desirable to double R21 and R22, and readjust R24 to make the meter range 30-230 beats-per-minute. It is also necessary to reduce R13 to 22K (trigger lockout period 240 ms) to permit heart rates over 200 beats-per-minute to register. Of course, the meter scale would have to be redrawn.

In spite of the above criticisms, I enjoyed the article very much. I am looking forward to more projects along this line. The use of electronics and computers in medicine is rapidly expanding, and I feel that many of your readers would jump at the chance of becoming familiar with some of the technology and principles involved.

EDWARD B. BORDEN, M.D.  
Bronx, NY

#### ETCHANT DISPOSAL

James Temple's "How to Make Your Own PC Boards" (July 1979 Issue) was interesting and I am looking forward to future articles.

With regard to disposal of ferric chloride etchants, the following comments are based partially on my own experience and partially on an excellent reference book, "Printed Circuits Handbook," C.F. Coombs, Jr., Editor, McGraw-Hill Book Co., 1967.

Disposal of expended etchants via a scavenger service is probably the only method that is both completely safe and legal in all communities, but scavenger services are not likely to be interested in handling individual hobbyists' quantities. Perhaps an organized group, such as an elec-

tronics club, could find a way to pool their waste chemicals.

Spent ferric chloride etchant can be made safer by neutralizing the acid with sodium carbonate. Sodium carbonate is sold in grocery stores as "sal soda" or "washing soda." Immediately after the etchant is expended, pour it into a plastic container large enough to allow for foaming. Rinse the tray with fresh water and pour that into the container. Slowly add the sodium carbonate neutralizer, while stirring with a wood or plastic utensil, until foaming ceases.

Disposal of waste chemicals in public sewers is forbidden in many communities, and for valid reasons. In the case of PC etchants, copper dissolved from the boards may upset the role of bacteria required for sewage breakdown and may destroy plants and fish if it ends up in natural waters. Small amounts of etchant would become extremely diluted by the large volume of water in a public sewer and probably would do no harm. On the other hand, hobbyists in rural areas who rely upon a single-dwelling sewage system (septic tank) may have cause for concern if they process a large number of boards.

Direct burial is an inexpensive and frequently used (but not necessarily legal) method of disposal. A disposal sump can be made by filling a hole several feet deep with coarse gravel. Neutralized etchant is poured into the gravel and washed down with fresh water to further dilute and disperse the chemicals.

L. SCOTT HOFER  
Federal Way, WA

GET YOURS FREE



RCA's 1980 CATALOG  
NEW IDEAS IN MUSICAL  
ELECTRONICS

PLEASE RUSH MY  
FREE 1980 CATALOG

name \_\_\_\_\_  
address \_\_\_\_\_  
city \_\_\_\_\_ state \_\_\_\_\_ zip \_\_\_\_\_

RCA ELECTRONICS, Dept. 1 • 1020 W. Wilshire, Oklahoma City, OK 73116

CIRCLE 56 ON FREE INFORMATION CARD

## An Electronic Service Technician speaks out for RCA SK's

To paraphrase Mr. Lysy, one of the ten winners in RCA's recent SK slogan contest, RCA SK's are indeed readily available. As for interchangeability, over 950 SK types replace over 153,000 domestic and foreign types. Our new SK numbering system which incorporates the other leading numbering system used by ECG\* REN and TM makes it easier than ever for you to identify the right SK replacement. And of course, SK reliability means fewer costly call-backs for you.

As Mr. Lysy points out, all these "Abilities" add up to the most important "Ability" of all... Profitability.

See your RCA SK distributor for all your solid state replacement needs and ask for your copy of the new authoritative RCA SK Replacement Guide, SPG 202X, or send your request with check or money order for \$1.50 to RCA Distributor and Special Products, P.O. Box 597, Woodbury, N.J. 08096.

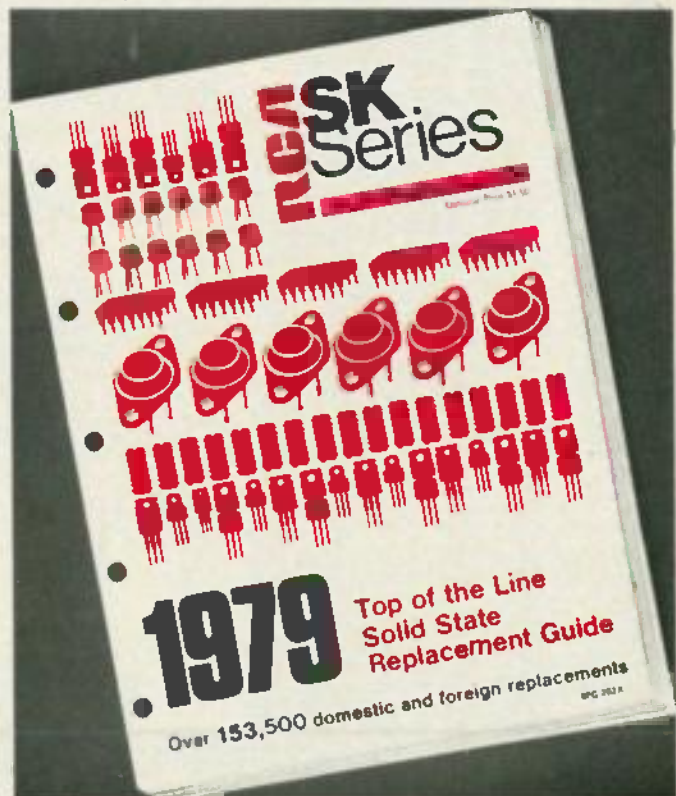

\*ECG is a trademark of GTE Sylvania

**RCA** SK Replacement  
Solid State

# equipment reports

## Panasonic Model RF-2900 Portable Multiband Radio

ONE OF THE MOST ATTRACTIVE MULTIBAND portable radios on the market is the model RF-2900 from Panasonic Corporation. While definitely not of communications quality, it does perform well for its intended applications.

Housed in an attractive black military-type case with chrome accents, the radio has a bright digital fluorescent display that provides an accuracy of 1 kHz through 30 MHz, and 100 kHz on FM.

The circuit is a double-conversion type for good selectivity. The frequency ranges are: 525 Hz-1605 kHz and 3.2 Hz-30 MHz (AM/CW/SSB) and 88 Hz-108 MHz (FM). Power is supplied by a 120 VAC source or by internal batteries (six D-cell batteries, which are not included). A dual-speed main tuning dial handles fine adjustment on all ranges. During battery operation, the dial lights and frequency display can be switched off to conserve power. An integral telescoping whip antenna enhances the receiver's portability; and external antenna



CIRCLE 101 ON FREE INFORMATION CARD

terminals are on the back of the case.

An S-meter acts as a tuning aid and often doubles as a battery tester. An adjustable BFO (beat-frequency oscillator) control permits the manual selection of CW (continuous-wave) pitch or LSB/USB reception.

Front-panel jacks are provided for an exter-

nal speaker (or headphones), a tape recorder output and an audio input to the receiver amplifier. In addition, a detachable sun shade for the frequency display and a carrying strap are included.

Testing the unit, we found the FM reception to be entirely adequate. The audio was clean, and the automatic frequency control was very effective for drift cancellation. The digital frequency display proved to be quite accurate in locating stations.

On the AM broadcast band the unit's selectivity was good. Images were undetectable through most of the tuning range; display accuracy was within 2 kHz; and the audio quality was found very good.

When the unit was used in the shortwave mode, high sensitivity brought in weak signals using only the whip antenna. A front-panel trimmer allows close frequency calibration. A wideband/narrowband selectivity switch provides sharp adjacent-channel rejection in any mode. The receiver displayed good mechanical stability.

It must be remembered that the model RF-2900 is a portable radio. *continued on page 26*

## BATTERY-WRAP WIRE WRAPPING TOOL MODEL BW-2630

- POSITIVE INDEXING
- ANTI-OVERWRAPPING
- BITS AVAILABLE FOR AWG 26, 28 & 30
- BATTERY OPERATED
- LIGHT WEIGHT



# \$19<sup>85</sup>\*

BATTERIES AND  
BIT NOT INCLUDED

U.S.A.  
FOREIGN  
PATENTS  
PENDING



**OK MACHINE & TOOL CORPORATION**  
3455 CONNER STREET, BRONX, N.Y. 10475, U.S.A.  
PHONE (212) 994-6600 • TELEX: 125091

BW-2630	BATTERY-WRAP TOOL	\$19.85
BT-30	BIT FOR AWG 30	\$ 3.95
BT-2628	BIT FOR AWG 26 & 28	\$ 7.95
RB-20	TWO NI-CAD BATTERIES	\$10.75

\*Minimum Billing \$25.00 / ADD SHIPPING CHARGE \$2.00 / NEW YORK CITY / STATE RESIDENTS ADD APPLICABLE TAX.

CIRCLE 25 ON FREE INFORMATION CARD

www.americanradiohistory.com

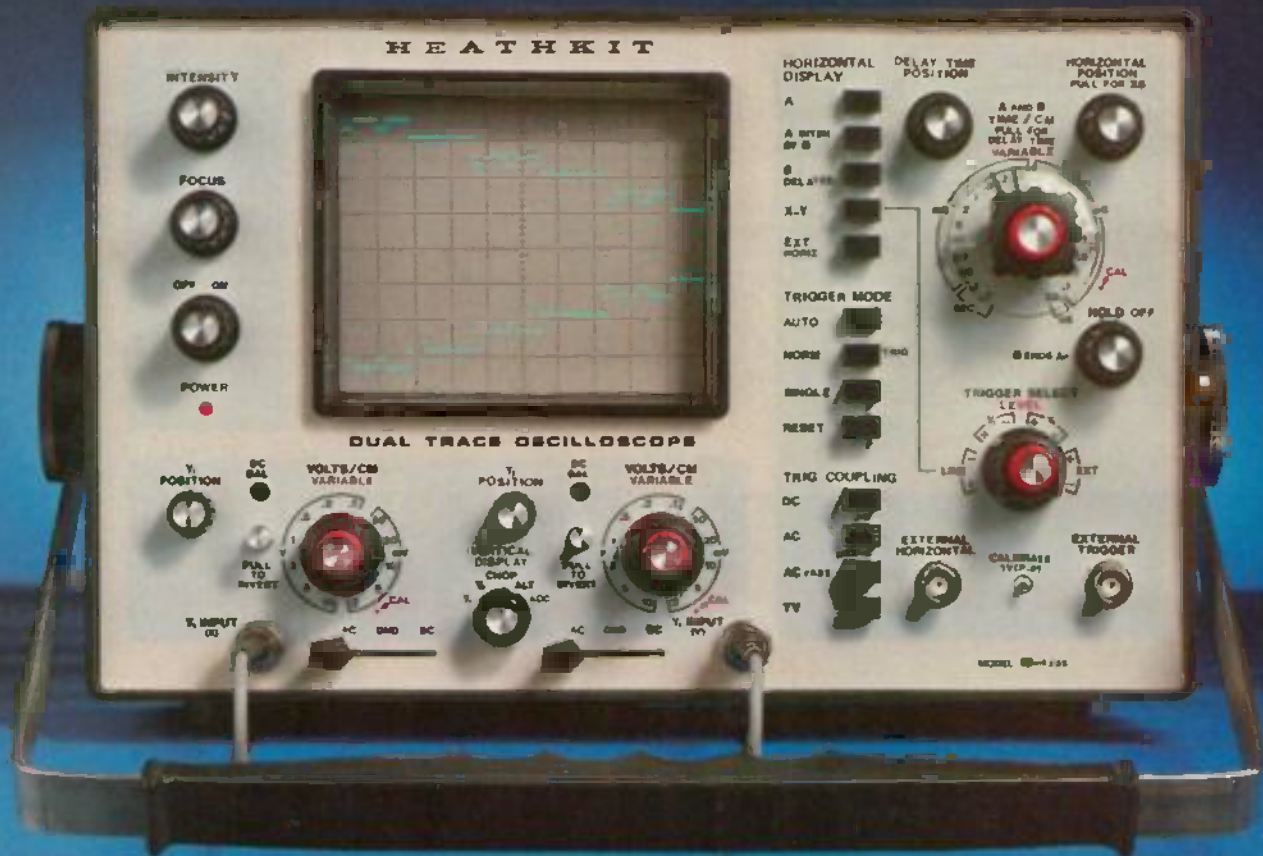

## LABORATORY QUALITY AT SERVICE BENCH PRICES

The most sophisticated scope ever offered in money-saving kit form: the new Heathkit IO-4235! Compare its features...compare prices...and you'll move up to the IO-4235

- DC-35 MHz response with smooth roll-off beyond 50 MHz
- Dual trace — study two signals simultaneously
- Delayed sweep — observe any section of a waveform — magnified as needed
- Fast sweep speeds from 50 nS/cm to 0.2 sec/cm, plus X5 expansion for effective speed of 10 nS/cm at the highest sweep rate \*
- TV triggering for jitter-free display
- 2 mV/cm to 10 V/cm vertical sensitivity
- Algebraic ADD with ability to invert  $Y_1$  or  $Y_2$
- Internal graticule for parallax-free measurements

# THE HEATHKIT® DC-35 MHz DUAL TRACE DELAYED SWEEP OSCILLOSCOPE

- 10 kV post-acceleration voltage — fastest, brightest display in any Heathkit oscilloscope ever

All these features and more, in a scope that's surprisingly easy to build and maintain! Circuit boards swing out for easy access to components even while the scope is operating. This Heathkit scope is one of the best values today... and for years to come!

Kit IO-4235... just \$869.95  
Also available factory assembled and tested....\$1195.00

Prices are mail order net F.O.B., Benton Harbor, Michigan. Prices and specifications subject to change without notice.

### FREE HEATHKIT CATALOG!

Send for your FREE Catalog with full descriptions of the IO-4235 and all the other exciting new Heathkit exclusives! Write to: Heath Company, Dept. 020-614 Benton Harbor MI 49022

Heathkit products are displayed, sold and serviced at Heathkit Electronic Centers nationwide units of Veritechnology Electronics Corporation. See your white pages.

GX-374

CIRCLE 75 ON FREE INFORMATION CARD

## EQUIPMENT REPORTS

continued from page 24

2900 is not designed as a communications receiver. It is primarily a portable radio with shortwave coverage. Serious single-sideband (SSB) or continuous-wave (CW) reception is difficult because of constant oscillator drift. Spurious signals were present throughout the shortwave tuning range. Dial backlash is quite noticeable on the higher frequency ranges. Frequency tuning is rapid, making fine adjustment difficult. Noise-limiter circuitry is not included, making the receiver vulnerable to an electrically noisy environment.

In spite of the receiver's problems with shortwave reception, it performs well for the AM/FM listener who wants good sound, port-

ability, an accurate frequency readout and access to shortwave broadcasts.

The model RF-2900 multiband portable radio sells for \$299.95 and is manufactured by Panasonic Corporation, One Panasonic Way, Secaucus, NJ 07094. R-E

## Radio Shack System Seven Stereo

GOOD THINGS COME IN SMALL PACKAGES! THIS familiar saying could well apply to the Radio Shack (500 One Tandy Center, Fort Worth, TX 7610) System Seven stereo. Although we all have a tendency to take manufacturer's specifications with a grain of salt, it appears that in this case, the manufacturer's good press is well deserved.



CIRCLE 102 ON FREE INFORMATION CARD

System Seven's matching *Minus-7* speakers (No. 40-2030) are reminiscent of the popular *Maximus* bookshelf speakers of more than a decade ago and perhaps even better. The speakers produce an astonishing bass and smooth, silky highs. Measuring only 7 X 4 1/2 X 4 1/2 inches, the cabinets are made of heavy metal casting, each enclosing a 4-inch high-compliance woofer and a 1-inch dome tweeter. Careful placement is one secret means of achieving maximum performance from these miniature dynamos!

The receiver (model STA-7) is handsomely designed. It is enclosed in a low-profile (16 1/2 X 3 1/2 X 12-inch) black-satin-finish metal cabinet. The blackout dial and tuning meter are attractively edge-lighted when the receiver is switched on.

The amplifier specifications are excellent: 15 Hz-30 kHz  $\pm 2$  dB; under 0.5% THD from 20-20,000 Hz into 8 ohms and a full 10-watt output.

The amplifier can accommodate several front-panel switch-selectable inputs. The rear apron houses an array of jacks in order to allow wide amplifier flexibility. A rear apron switch provides 6.5-dB bass enhancement for the matching speakers.

The AM/FM tuner stages are equally impressive: FM sensitivity (IHF) is typically 2.2  $\mu$ V; limiting sensitivity (-3 dB) is 3.2  $\mu$ V; S/N ratio (1 mV) is 60 dB; total harmonic distortion (stereo) is 0.6%; stereo separation (at 1 kHz) is 34 dB; image rejection is 50 dB; IF rejection is 80 dB; and selectivity is 45 dB.

A built-in ferrite loop is provided for AM reception, and line-cord coupling can be used for metropolitan FM listening. External antenna terminals are provided on the rear apron for both AM and FM reception.

Power requirement is either 120 VAC or 240 VAC.

### Our test

Initial hookup and installation were easy; we followed the suggestions outlined in the literature that accompanies the system. Our advice: DO READ the instructions. Speaker placement is critical for optimum performance. You need speaker hookup wire; and use color-coded zip cord of adequate gauge in order to insure proper phasing and efficient power transfer.

The tuning dial markings are well-spaced and easy to read, and the flywheel tuning knob has a professional feel. FM stability is excellent, with warm-up drift undetectable. The bass and treble controls have detent stops, giving the impression of incremental steps; similarly, the balance control has a center-position detent stop. We liked these features. Although the quality of sound from the System Seven would merit using the most expensive stereo headphones, we selected a set of Realistic's new model PRO-20 headphones (\$24.95) to see how well they would perform with the receiver. The results were quite satis-

continued on page 32



## Sometimes It Pays To Have Nosey Friends

... friends that give you a firm grip on fine work in tight places. That make it easy to reach the hard to reach. Long nose pliers by CHANNELLOCK. Slender, perfectly mated jaws with no side wobble. Sharp, hand honed cutters. Beautiful high polished finish. Blue dipped plastic comfort grips. Quality in every detail (at no premium in price). CHANNELLOCK. Be sure that name is on the pliers YOU buy.

# CHAN NEL LOCK

CHANNELLOCK, INC. • Meadville, Pennsylvania 16335

Meet The Rest Of The Family. Send For Free Catalog.

CIRCLE 18 ON FREE INFORMATION CARD





An Extraordinary Offer to introduce you to the benefits of Membership in

# ELECTRONICS BOOK CLUB

take any **6** (up to 9 books) of these 24 unique electronics selections **\$1.99** for **ALL SIX** (values to \$111<sup>55</sup>) for only

with a Trial Membership in the Book Club that guarantees to save you 25% to 75% on a wide selection of electronics books



### Facts About Club Membership

- The 6 introductory book selections of your choice carry publisher's retail prices of up to \$111.55. They are yours for only \$1.99 for all 6 (plus postage/handling) with your Trial Membership.
- You will receive the Club News describing the current Selections, Alternates, and other books, every 4 weeks (13w a year).
- If you want the Selection, do nothing, it will be sent to you automatically. If you do not wish to receive the Selection, or if you want to order one of the many Alternates offered, you simply give instructions on the reply form (and in the envelope) provided, and return it to us by the date specified. This date allows you at least 10 days in which to return the form. If, because of late mail delivery, you do not have 10 days to make a decision and so receive an unwanted Selection, you may return it at Club expense.
- To complete your Trial Membership, you need buy only four additional monthly Selections or Alternates during the next 12 months. You may cancel your Membership any time after you purchase these four books.
- All books—including the introductory Offer—are fully returnable after 10 days if you're not completely satisfied.
- All books are offered at low Member prices, plus a small postage and handling charge.
- Continuing Bonus: If you continue after this Trial Membership, you will earn a Dividend Certificate for every book you purchase. Three Certificates plus payment of the nominal sum of \$1.99 will entitle you to a valuable Book Dividend of your choice which you may choose from a list provided Members.

May we send you your choice of 6 of these practical time-and-money-saving book selections as part of an unusual offer of a Trial Membership in Electronics Book Club?

Here are quality hardbound volumes, each specially designed to help you increase your know-how, earning power, and enjoyment of electronics. Whatever your interest in electronics, you'll find Electronics Book Club offers practical, quality books that you can put to immediate use and benefit.

This extraordinary offer is intended to prove to you through your own experience, that these very real advantages can be yours...that it is possible to keep up with the literature published in your areas of interest, and to save substantially while so doing. As part of your Trial Membership, you need purchase as few as four books during the coming 12 months. You would probably buy at least this many anyway, without the substantial savings offered through Club Membership.

To start your Membership on these attractive terms, simply fill out and mail the coupon today. You will receive the 6 selections (up to 9 books) of your choice for 10-day inspection. YOU NEED SEND NO MONEY. If you're not delighted, return the books within 10 days and your Trial Membership will be cancelled without cost or obligation.

ELECTRONICS BOOK CLUB, Blue Ridge Summit, Pa. 17214  
**CIRCLE 47 ON FREE INFORMATION CARD**

### ELECTRONICS BOOK CLUB

Blue Ridge Summit, Pa. 17214

Please open my Trial Membership in ELECTRONICS BOOK CLUB and send me the 6 selections circled below. I understand the cost of the books I have selected is only \$1.99 for all 6, plus a small shipping charge. If not delighted, I may return the books within 10 days and owe nothing, and have my Trial Membership cancelled. I agree to purchase at least four additional books during the next 12 months, after which I may cancel my membership at any time.

604/882 637/628 678 714 730  
 861/905 952 1053 1085 1097 1101  
 1119 1123 1120 1128 1138 1152  
 1168 1169 1174 1176 1201 1241 6277

Name \_\_\_\_\_ Phone \_\_\_\_\_

Address \_\_\_\_\_

City \_\_\_\_\_

State \_\_\_\_\_ Zip \_\_\_\_\_

(Valid for new Members only. Foreign and Canada add 15%.) RE-180

# Train with NTS for the MicroComputers, digital the first name



Industrial Electronics

## MicroComputers

The world of electronics is daily becoming more challenging. Technology is growing more specialized, and the importance of digital systems increases every day. Test instruments, home entertainment units and Industrial control systems are all going digital. And now, NTS training programs include a wider choice of solid-state and digital equipment than ever before offered in any home study course: Advanced NTS/Heath digital color TV (25" diagonal with optional programming capability), NTS/Heath microcomputer, digital test equipment, digital stereo receiver (70 watts per channel), NTS compu-trainer, plus much more state-of-the-art equipment to make your training exciting and relevant.

The equipment you receive with NTS training programs is selected to provide you with a solid

background in electronic systems. Kits and lessons are designed to work together to demonstrate electronic principles and applications. The kit-building not only shows you how electronic hardware functions, but how various circuit designs accomplish different purposes. Your lessons guide you through any number of experiments associated with many projects. This is the Project-Method, and it works. Step-by-step, you learn how and why digital electronics has become a part of our world, and the even bigger role it is sure to play in the future.

Whether you are looking for training in Consumer, Commercial, or Industrial electronics, NTS offers fourteen courses, some basic, many advanced, in several areas of electronics. An all-new full-color NTS catalog shows you what each course covers.

# electronics of the future.

systems and more...from  
in home study.



Test Instruments

Digital  
Color TV

Basic  
Electronics

Simulated TV Reception

and every piece of equipment included.  
Send for it today, and see for yourself what's really happening in electronics training technology at NTS. Find out how much has changed, and what new directions the field is taking. You'll probably want to be a part of it.  
It's free. Just mail the card or coupon. Today.

NO OBLIGATION. NO SALESMAN WILL CALL.  
APPROVED FOR VETERAN TRAINING.

**NATIONAL TECHNICAL SCHOOLS**

TECHNICAL-TRADE TRAINING SINCE 1905  
Resident and Home-Study Schools  
4000 South Figueroa St., Los Angeles, Calif. 90037

**NATIONAL TECHNICAL SCHOOLS** Dept. 206-010  
4000 South Figueroa Street, Los Angeles, California 90037

Please send FREE Color Catalog and Sample Lesson.

- Color TV Servicing
- B & W TV and Radio Servicing
- FCC License Course
- Electronic Communications
- Electronics Technology
- Audio Electronics Servicing
- Digital Electronics
- MicroComputers/MicroProcessors

Name \_\_\_\_\_

Address \_\_\_\_\_

Apartment Number \_\_\_\_\_ Age \_\_\_\_\_

City \_\_\_\_\_

State \_\_\_\_\_ Zip \_\_\_\_\_

- Check if interested in G.I. Bill information
- Check if interested ONLY in classroom training in Los Angeles

**EQUIPMENT REPORTS**  
continued from page 26

factory; these low-cost phones are a good choice in matching economy stereo headphones for noncritical requirements.

Clearly, the *System Seven* is a product for other manufacturers to reckon with; it should become a standard of comparison among low-cost, high-performance component music systems. The Radio Shack *System Seven* sells for \$219.95. **R-E**

**B & K Model E-200D RF Signal Generator**



CIRCLE 103 ON FREE INFORMATION CARD

A REASONABLY PRICED, METERED-OUTPUT signal generator is a difficult item to find. B & K's model *E-200D* RF Signal Generator helps fill that void.

The *E-200D* is a handsome, husky compact generator featuring straightforward operation. Functions are very clearly marked, and familiarization comes quickly. The accompanying

owner's manual is well written, and very flexible in its subject matter. The usual circuit descriptions and control identifications are provided, but several other text subjects are included. A handy dB-to-microvolt conversion table is provided and is very helpful for sensitivity measurements. Alignment procedures for AM radios, FM receivers, and TV sets are given step-by-step.

The *E-200D* measures 12 1/4 x 7 1/4 x 8 inches, and weighs 14 pounds. It is securely enclosed in a steel cabinet, AC powered through a 3-wire grounded cord.

Fundamental frequency generation ranges from 100 kHz through 54 MHz, with calibrated harmonics usable through 216 MHz (TV Channel 13). Frequency accuracy is advertised as being  $\pm 1.5\%$  of highest frequency on any band, usable to 0.1% with internal calibrator. The calibrator is heterodyned against the signal generator frequency, producing an audio beat note that can be heard from an internal speaker.

RF signal voltage output (maximum) varies from 3 volts (lowest frequencies) to 0.3 volt (highest frequencies). Using the calibrated attenuator and level control, the output level may be selectively adjusted from -106 dB ( $.5\mu\text{V}$ ) to +2 dB (216,000  $\mu\text{V}$ ) at 50 ohms. Accuracy throughout the entire fundamental frequency range is specified as being within 2 dB.

Modulation is provided by an internal 400 Hz ( $\pm 20\%$ ) bridged-T oscillator. Level is set at 1V RMS for 50% modulation. External and internal sources of modulation are both continuously adjustable and metered.

Both a block diagram and circuit schematic are included for servicing the generator, and to

make internal calibration easier. The subject of calibration needs to be mentioned. While it is possible to bring the *E-200D* into specified accuracy, the unit that we evaluated was considerably off in its dial reading. On several lower-frequency segments, (between 100 kHz and 9 MHz) the adjustable hairline could not be offset far enough to coincide with the actual output frequency. Nonlinearity in the dial ranges aggravates the problem. Although we made no attempt to align the unit, our feeling is that it could probably be brought within specifications.

To assist with calibration accuracy, two internal reference oscillators are included. The 1-MHz crystal oscillator is very accurate and stable. It is usable up to about 33 MHz. The 100-kHz oscillator is an L-C unit, and had strayed considerably off frequency. Adjustment of the 100-kHz calibrator is easily accomplished by aligning the slug of the oscillator coil, readily accessible through a small hole in the shielded RF section.

Shielding and mechanical stability are two vital areas in any signal generator design. We were pleased at the RF isolation provided by the extensive copper-plated steel shielding. The cabinet cover is also interlocked to discourage stray radiation.

One of the most serious drawbacks in using inexpensive hobby-type RF signal generators comes with low signal levels. When it is important that very low output signals (in the micro-volt region) must be used to measure maximum sensitivities of radio receiving equipment, stray radiation will wreak havoc! These leakage paths may occur between cabinet/panel cracks, or with poor cable shielding, poor

continued on page 34

# Now, an automotive computer plus cruise control at your fingertips!

This is CompuCruise! The first true computer for your car, truck or RV. It's the most effective and functional cruise control ever designed, PLUS complete trip computing, an efficient fuel management system, and a split-second-accuracy quartz time system.

CompuCruise is a cruise control with a memory. A unique seek-and-hold capability makes highway driving easier and more enjoyable. Fully electronic, making it more accurate and reliable.

CompuCruise is a true computer, constantly reacting via automatic sensors to changing conditions, updating vital data for you every second. Just look at what CompuCruise gives you:

- Time, E. T. Lap timing, Alarm
- Time, Distance, Fuel to arrival
- Time, Distance, Fuel to empty
- Time, Distance fuel on trip
- Current or average MPH, MPG, GPH
- Fuel used, Distance since fillup
- Inside, outside or coolant temp.
- Battery voltage
- English or Metric display

CompuCruise works on foreign or American cars (except Diesel and fuel-injected vehicles). It's priced for the budget-minded, and easily installable by you or your automotive outlet.

Only \$199.95 with Cruise Control, \$159.50 without. Fully warranted for 90 days from date of purchase. Delivered

complete with easy-to-follow installation guide. And backed by a 100% satisfaction guarantee. If not fully satisfied when you receive your unit, return it before installation and your money will be fully refunded without question.

For the name of your nearest dealer, call or write us right now: ZEMCO, 12907 Alcosta Blvd., San Ramon, CA 94583. Phone (415) 838-8060.

Do it today—for a better cruise control and more automotive information than you've ever had before.

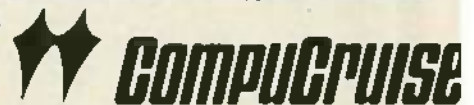

CIRCLE 4 ON FREE INFORMATION CARD

# The Affordable Computer You've Been Waiting For

Dozens of new small computers have flooded the marketplace. It seems as if everybody (and their pal) have come out with new, low cost personal computer systems. In this micro-computer jungle, one stands out as the obvious choice . . . .

# ATARI

**Why?** First of all, no manufacturer has spent the time and effort to support their machine the way ATARI has. They could have released it six months ago, but they chose to wait until they developed software programs, add-on accessories, and an intricate dealer support network. The manuals are expertly written, easy to follow, and far from boring! Their computer is well designed and carefully assembled. ATARI software is outstanding, and easy to use. Both the ATARI 400 and 800 have been designed for non-programmers as well as the experienced programmer.

## Applications such as . . . . .

. . . . . music composition, electronic art, and household security are all possible with the ATARI computer. More sophisticated needs, such as those of small businesses can be easily handled by the more expandable ATARI 800. Even larger companies with overloaded main computers will find the ATARI a welcome relief.

For the home there are programs such as Personal Finance Management, Income Tax, Household Appliance Control, Database Access, Investment Management, Typing Trainer, File Card and Personal Record Keeping. These programs will not only save you time and money but provide accurate, up to date records. You will have instant access to data and substantial help in financial planning.

The educational aspects of the system are also a major feature of the ATARI. There is an entire library of personalized, self paced instruction in a wide variety of subjects providing effective teaching for all age groups. It makes learning a more enjoyable experience, one which remains challenging and interesting no matter how many times the programs are run.

The entertainment programs follow the same format. There are Creative Programs, Action, Simulation and Thinking Games. There is challenge, fun and skill development in all of these well thought out programs.

Business programs like Text Editor, Inventory Control, Accounts Payable/Receivable will save you both time and money. The Mailing List,

Calendar, Payroll and Sales Forecasting software will help you make money and also save time for more important functions. These programs are easy to use, inexpensive and well documented.

All in all the ATARI 400 and 800 computer systems provide a streamlined method of managing business and household affairs. It is a personal computer designed for people with no previous computer experience, but one that does not compromise capability for the more experienced computerist.

**For more information or to place your order call:**

## HOBBYWORLD HW Computer Division

**Toll Free: (800) 423-5387**

**In Calif: (800) 382-3651**

**Local: (213) 886-9200**

Use your Visa or Mastercharge!

**Send to: HobbyWorld  
19511 Business Ctr. Dr. Dept. R1  
Northridge, CA 91324**

### Please Send Me:

- Atari 400 Personal Computer plus \$8 shipping and handling, #2171 . . . . . \$550.00
- Atari 800 Personal Computer plus \$9 shipping and handling, #2173 . . . . . \$995.00
- Atari Program Recorder for 400, #2176 . . . . . \$ 90.00
- Atari Disk Drive for 800, #2174 . . . . . \$750.00
- Atari Printer for 800, #2175 . . . . . \$600.00
- Please send me more information!

Subtotal . . . . . \$ \_\_\_\_\_

California Residents add 6% sales tax . \$ \_\_\_\_\_

Shipping & Handling . . . . . \$ \_\_\_\_\_

Total . . . . . \$ \_\_\_\_\_

check  money order  Visa

Master Charge: Code# \_\_\_\_\_

Acct.# \_\_\_\_\_ Exp. Date \_\_\_\_\_

Signature \_\_\_\_\_

Name \_\_\_\_\_

Address \_\_\_\_\_

City \_\_\_\_\_ State \_\_\_\_\_ Zip \_\_\_\_\_

# Interface your TRS-80 to the "real world" the faster and easier way.

A P has the hardware you need  
to build the Interface breadboard  
described in the article on page 52.

**The Jumper.** A 24" 40  
conductor flat ribbon  
cable assembly with  
a socket connector  
on one end, a card-  
edge connector on the other. It's  
preassembled and every line is  
pretested. 924150-24 \$11.95



**The Solderless Breadboard.** It's our famous "Superstrip" for  
unlimited freedom in the layout and implementation of your circuits.  
923252-R \$17.00



**The Header.** Copper alloy 770  
for instant plug-in access to the PC  
board. 923875-R \$2.79

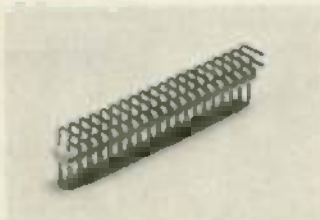

Available at your dealer; for the  
nearest one, phone (toll-free)  
800-321-9668. And ask for the  
complete A P catalog, The Faster and Easier Book.



"Faster and Easier is  
what we're all about."



**A P PRODUCTS  
INCORPORATED**

Box 1108 • 72 Corwin Drive  
Painesville, Ohio 44077  
Tel. 216/354-2101  
TWX: 810-425-2250

ground strapping, AC line radiation, or even loose panel hardware. The *E-200D* seems to have much lower stray radiation than most other low-cost competitive signal generators. That condition must be attributed in large part to the heavy shielding around the internal oscillator section.

While the shielding made the unit relatively RF tight, mechanical instability is still apparent, especially at higher frequencies. A gentle tap on the cabinet will cause severe detuning on the upper ranges. Above 5 MHz, the frequency dial tuning becomes increasingly rubbery, making close adjustment virtually impossible on close tolerance alignment. Thermal drift, however, is minimal with this solid-state instrument.

Considerable frequency pulling occurs from the attenuator control. With the dial set at some useful frequency, rotating the fine attenuator control results in extensive frequency change. Even though the attenuator pot is isolated by a buffer stage, interaction with the oscillator is still quite prevalent. Some loading effect on frequency is also noted when the output of the generator is connected to its injection point in the circuit to be checked.

Metering in any unit is desirable. Obviously, absolute accuracy cannot be expected except in generators costing considerably more than the *E-200D*, but used as a relative reference, it can be very useful. For most applications, and non-demanding test bench use, the *E-200D* is loaded with useful features. The *E-200D* RF signal generator sells for \$300. Available from B & K Precision, Dynascan Corp., 6460 W. Cortland St., Chicago, IL 60635. R-E

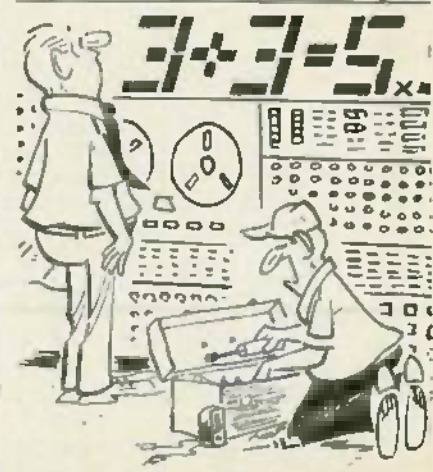
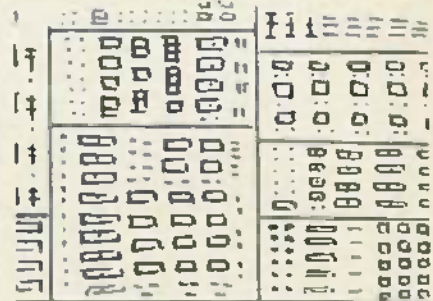

"Well, naturally—if you insist upon looking for mistakes, then you're bound to find some."

# \$89.95\* Now buys a top-quality yoke/flyback tester

Get Heathkit reliability and spend a lot less

New Heathkit Tester gives you simple, reliable checks of horizontal and vertical yokes, flybacks, horizontal linearity and efficiency coils, and general mid-frequency coils. Checks in or out of circuit. Even measures drive signals in horizontal circuits.

Simple, accurate "good-bad" ring test tells you all you need to know. One easy probe gives you focus and anode voltage measurements. The new, portable Heathkit Yoke/Flyback Tester uses only top-quality components for a long, reliable service life. And it costs a lot less than any similar tester available today.



## FREE CATALOG

See the complete line of Heathkit TV instruments, including CRT rejuvenator, color alignment generator, tube checker, high-voltage probe meter, scopes and power supplies — all in money-saving, easy-to-build kits. Most items are also available in assembled form.

The new Heathkit Catalog includes nearly 400 exciting electronic kits for your home, work or pleasure. Send for yours today.

\*In easy-to-build kit form. (IT-5235). Also available completely assembled and tested at \$130.00 (ST-5235).

## Heathkit

Heath Company,  
Dept. 020-615<sup>®</sup>  
Benton Harbor, MI 49022

Heathkit Products are also sold and serviced at Heathkit Electronic Centers (units of Veritechnology Electronics Corp.) in major cities throughout the U.S. See your white pages. Prices are subject to change without notice.

GX-368

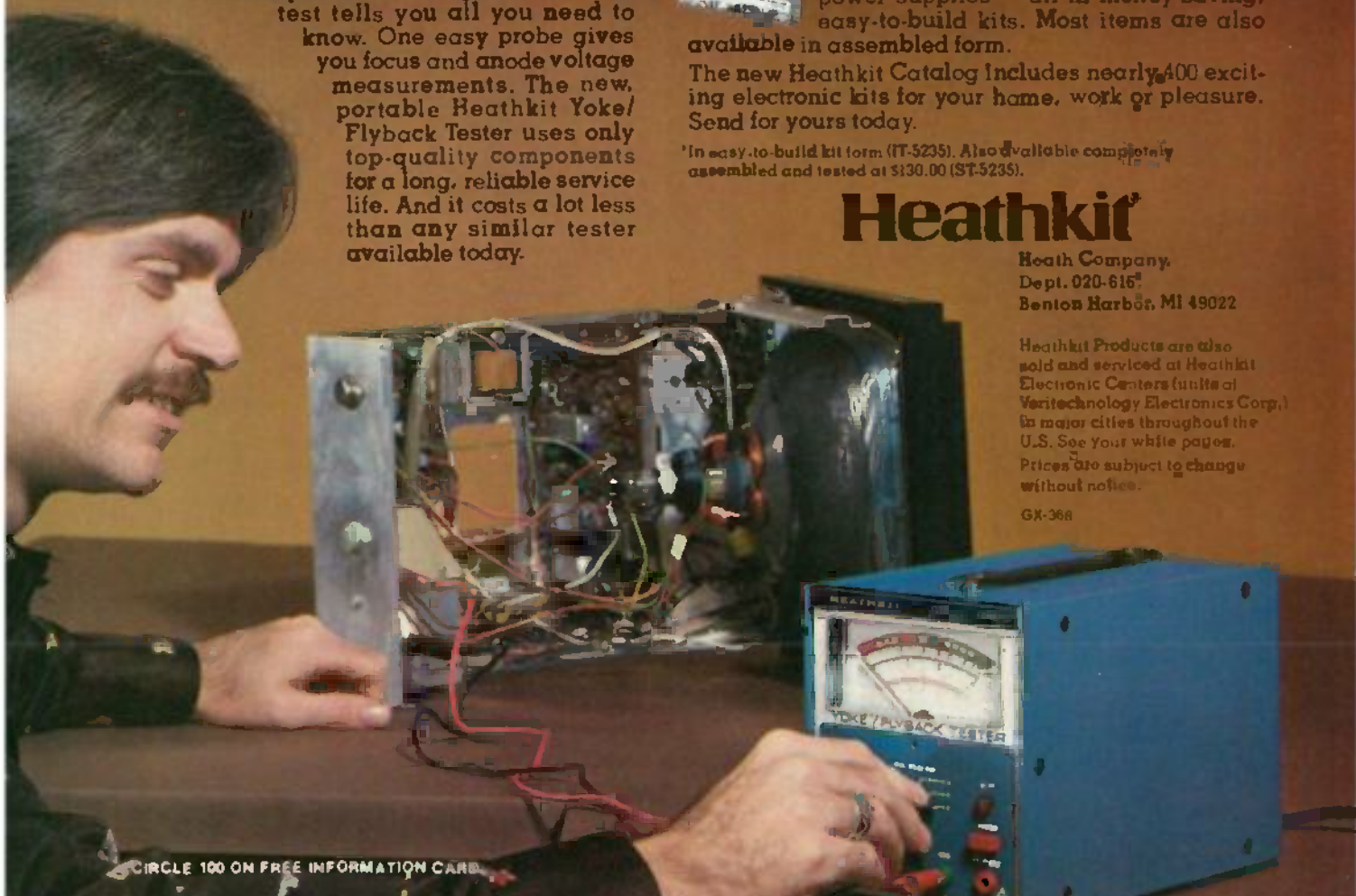

CIRCLE 100 ON FREE INFORMATION CARD

# When quality counts

Do not be fooled by the low prices, these brand new lab quality frequency counters have important advantages over instruments costing much more. The models 7010 and 8010 are not old counters repackaged but 100% new designs using the latest LSI state-of-the-art circuitry. With only 4 IC's, our new 7010 offers a host of features including 10 Hz to 600 MHz operation, 9 digit display, 3 gate times and more. This outperforms units using 10-15 IC's at several times the size and power consumption. The older designs using many more parts increase the possibility of failure and complexity of troubleshooting. Look closely at our impressive specifications and note you can buy these lab quality counters for similar or less money than hobby quality units with TV xtal time bases and plastic cases!

Both the new 7010 and 8010 have new amplifier circuits with amazingly flat frequency response and improved dynamic range. Sensitivity is excellent and charted below for all frequencies covered by the instruments.

Both counters use a modern, no warm up, 10 MHz TCXO [temperature compensated xtal oscillator] time base with external clock capability - no economical 3.579545 MHz TV xtal.

Quality metal cases with machine screws and heavy gauge black anodized aluminum provide RF shielding, light weight and are rugged and attractive - not economical plastic.

For improved resolution there are 3 gate times on the 7010 and 8 gate times on the 8010 with rapid display update. For example, the 10 second gate time on either model will update the continuous display every 10.2 seconds. Some competitive counters offering a 10 second gate time may require 20 seconds between display updates.

The 7010 and 8010 carry a 100% parts and labor guarantee for a full year. No "limited" guarantee here! Fast service when you need it too, 90% of all serviced instruments are on the way back to the user within two business days.

We have earned a reputation for state-of-the-art designs, quality products, fast service and honest advertising. All of our products are manufactured and shipped from our modern 13,000 square foot facility in Ft. Lauderdale, Florida.

When quality counts...count on Optoelectronics.

CIRCLE 8 ON FREE INFORMATION CARD



- 100% U.S.A. FACTORY ASSEMBLED
  - 100% PARTS & LABOR YEAR GUARANTEE
  - CERTIFIED NBS TRACEABLE CALIBRATION
  - EXTERNAL CLOCK INPUT
  - DISPLAY HOLD FUNCTION
  - 9 RED LED DIGITS 4" HIGH
  - .1 Hz RESOLUTION
  - 0.1 PPM 10 MHz TCXO TIME BASE
  - LAB/PORTABLE-AC ADAPTER INCLUDED
  - 1 MEGOHM & 50 OHM INPUTS
  - STATE-OF-THE-ART LSI DESIGNS
  - COMPREHENSIVE USER MANUAL PROVIDED
- COMPACT SIZES—7010- 1-7/8" Hx4-1/4" Wx5-1/4" D 8010- 3" Hx7-1/2" Wx6-1/2" D

MODEL	\$ PRICE	RANGE 10Hz to	LED DIGITS	SENSITIVITY			HI-Z INPUT 10Hz - 60 MHz	GATE TIMES	RESOLUTION			TCXO TIME BASE		EXT. CLOCK INPUT	NI-CAD BATT. PACK
				25-250 MHz	250-450 MHz	450 MHz-1GHz			12 MHz	60 MHz	MAX. FREQ.	20° -40°C	FREQ.		
7010	145.00	600 MHz	9	5-20 mV	10-30 mV	20-40 mV to 600 MHz	1-10 mV	{3} .1, 1, 10 SEC	.1 Hz	1 Hz	10 Hz 600 MHz	1 PPM 0.1 PPM	10 MHz	YES	YES
7010.1	225.00													OPTION \$25.	OPTION \$15
8010	325.00	1 GHz	9	1-10 mV	5-20 mV	10-25 mV	1-10 mV	{8} .01, 20 SEC	.1 Hz	1 Hz	10 Hz 1 GHz	1 PPM 0.1 PPM	10 MHz	YES	YES
8010.1	495.00													STD	OPTION \$30.

\* Has precision 0.1 PPM TCXO time base.

#### MODEL 7010

#7010 600 MHz Counter - 1 PPM TCXO \$145.00  
#7010.1 600 MHz Counter - 0.1 PPM TCXO \$225.00

#### OPTIONS

#Ni-Cad-701 Ni-Cad Battery Pack & charging circuitry installs inside unit \$ 15.00  
#EC-70 External Clock Input 10 MHz \$ 25.00  
#CC-70 Carry Case, Padded Black Vinyl \$ 8.95

#### MODEL 8010

#8010 1 GHz Counter - 1 PPM TCXO \$325.00  
#8010.1 1 GHz Counter - 0.1 PPM TCXO \$495.00  
#8010.1.1 1.3 GHz Counter - 0.1 PPM TCXO \$495.00

#### OPTIONS

#Ni-Cad-801 Ni-Cad Battery Pack & charging circuitry installs inside unit \$ 39.00  
#CC-80 Carry Case, Padded Black Vinyl \$ 9.95

#### ACCESSORIES

#TA-100 Telescope Ant with Right Angle BNC \$ 9.95  
#P-100 Probe, 50 ohm, 1x \$13.95  
#P-101 Probe, Lo-Pass, Audio Usage \$16.95  
#P-102 Probe, HI-Z, General Purpose \$16.95



ORDER FACTORY DIRECT • CALL TOLL FREE



**Optoelectronics inc**

5821 N.E. 14th Avenue, Fort Lauderdale, Florida 33334

**1-800-327-5912**

FROM FLORIDA (305) 771-2051/2

TERMS: Orders to U.S. and Canada, add 5% for shipping, handling and insurance to a maximum of \$10.00. All other orders add 10%.



# DESIGN YOUR OWN ANDROID

*No doubt many of you have dreamed of the day when you will have an android at your beck and call. Well, that day is not yet here but you can get an early start by designing your own android. Here are the basics.*

MARTIN BRADLEY WEINSTEIN

THERE ARE AT LEAST HALF A DOZEN INDIVIDUALS in America who have designed and built their own working robots, and at least two companies now offer robot plans and kits as commercial products. The day when almost anyone can go to his hobby workshop and emerge with a home-built robot is more than near; it's arrived.

But that isn't the kind of project to go into with a headlong plunge. There are many important decisions to be made at the outset. And a complex, interwoven electronic/mechanical/human engineering task to be accomplished.

What is offered here is not a set of plans, nor the final word in design; it is a thought-out attempt at organizing and recording one man's decisions on how to approach that design task. You will have to make your own judgments as to whether or not these decisions apply to the robot or android *you* build.

## The first step: defining terms

To avoid confusion—but not necessarily to define these terms for anyone but ourselves—let's sort out what we mean by terms like *robot*, *android*, and so on.

The key considerations are mobility, control, independence, and the ability to learn by experience and adaptability.

A *robot* is a mechanism, fixed or mobile, possessing the ability to manipulate objects external to itself under the constant control of a human being, a computer, or some other external intelligence.

An *automaton* is a mechanism, fixed or mobile, possessing the ability to manipulate objects external to itself under the constant control of a programming routine previously supplied by an external intelligence.

An *android* is a mobile mechanism possessing the ability to manipulate objects external to itself under the constant control of *its own* resident intelligence, operating within guidelines initially established and occasionally updated by a human being, a computer, or some other external intelligence.

A *cyborg* (or "cybernetic organism") is an android capable of heuristic (learning by experience) updating of its own resident intelligence.

A *mandroid* is an android or cyborg in the shape, size, and likeness of a human being. Mandroids might be used, for example, to pilot aircraft or ground vehicles, initially designed for human operation, through dangerous or humanly unsurvivable conditions.

## Philosophical aspects

Frankly, my decision to build an android was an emotional impulse. I knew that the necessary technology existed, and I knew I *could* build one. So I decided to do it before I decided just what my creature should do.

When I announced my intention to several friends and colleagues—who have been enthusiastic and supportive—I found that the almost universal response to my announcement "I've decided to

build a robot" was the understandable question "What will it do?" This article is, in part, my attempt to answer that question.

With a bow to Dr. Isaac Asimov (whose science fiction classic *I, Robot* introduced the "Laws of Robotics"), here are the criteria for our tentative first steps at android design that comprise our own "laws of robotics."

First, our creations should not be destructive to any part of their environment, including living cohabitants, walls and furniture, the breathableness of the air, radiation levels, or anything else.

Second, our creations should not be destructive to themselves. We need to include adequate hardware and software protection to assure self-preservation, except where that violates our first "law."

Third, we must design in an instinct for survival, meaning here self-continuance of operation, except where that would violate the first two laws. The most immediate manifestation of the survival trait, for example, would be a mechanism to assure that low batteries would be recharged before failure. (Throughout our text, the term "mechanism" will be used to identify any means—hardware, software, human cooperation, whatever—by which an end, or design goal, may be achieved.)

## Obstacles in the human environment

If our robots and androids are to "live" with us, they must be capable of maneu-

vering through our individual environments. To better appreciate the difficulties that entails, join us in a little mental scenario for a fast experimental demonstration.

Imagine that you have a remote-controlled motorized toy, and that you want to drive it on a tour of your house. As you do so, make a list of the goals you are setting for yourself, and be sure to list the specific obstacles that make your task more difficult.

Figure 1 shows a typical (for the sake of this discussion, anyway) upstairs floorplan for a Colonial home. Even with no furniture to contend with, we can quickly identify a number of obstacles: stairs, narrow hallways, doors, and closets.

Figure 2 takes us into a sparsely furnished room, where furniture, cords, and so on begin taking a significant role.

While the detail of your imaginary excursion might vary from ours, you will notice that the goals and obstacles listed in Table I offer a good, fairly general, starting point for our design.

That gives us some of our first requirements for our robot or android: obstacle recognition, collision avoidance, and obstacle manipulation.

One example of that might be recognizing a closed door and not colliding with it, but opening it, then proceeding.

#### Stairways

A vehicle with wheels of the same order of size magnitude as a step cannot negotiate the step in a controlled manner.

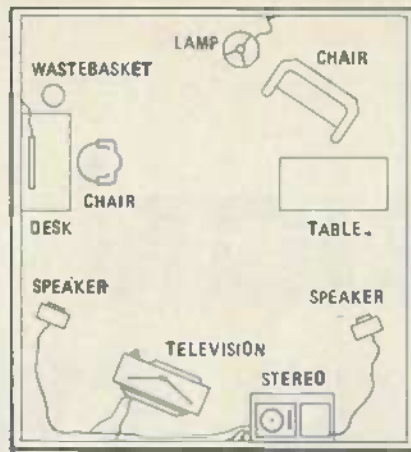

FIG. 2—FURNISHED ROOM presents many obstacles to an android.

In other words, you might be able to ride a bicycle up and down a stairway—but you wouldn't want to try it in a go-cart.

So large wheels are one possible answer to the problem of negotiating stairs.

Another solution, which you may have seen back in the 60's in artists' renderings of proposed lunar vehicles, approximates the action of a single large wheel by using a triangular array of three wheels: both the array and each individual wheel may be driven.

Walking—the approach favored by humans and animals—presents problems in balance and locomotion that are best left alone at present, considering the technology available to us.

Still another possible answer is to use the principle of a tracked vehicle. A vehi-

cle with twin tracks and two reversible motors not only solves the problem of forward and reverse motion, even over stairways and uneven terrain; it also makes turning easier to accomplish, especially within a small radius.

However, when such a vehicle begins climbing or descending the stairs, the tendency to topple must be overcome. That tendency can be reduced by first designing the vehicle with a low center of gravity. That means keeping the more massive components as close to the ground as possible, keeping the height of the machine reasonable as opposed to the geometry of its base, and keeping the higher parts of the machine as lightweight as possible.

Also, we ought to consider a mechanism for keeping the main body of the machine upright no matter what the attitude of its base. (That's angular attitude, not emotional attitude—though at times it can seem that way.)

TABLE I

#### GOALS

- Steer away from walls
- Steer around and between furniture
- Avoid wires and cords
- Follow long, straight clear paths
- Continue forward, avoid reverse

#### OBSTACLES

- Closed doors
- Stairs
- Carpets and high-drag surfaces
- Transitions between floorings
- Hanging items extending from walls
- Shelves
- People and pets
- Clutter on floors
- Wires and cords
- Closets and cabinets
- Narrow hallways
- Fireplaces

#### Physical aspects

You've probably heard that a woman's high heel exerts more force per unit area than an elephant or a jumbo jet. While you probably haven't been considering having an elephant or a jumbo jet walking around your house, you don't have too many fears of a woman in high heels doing the floor in.

No, we're not suggesting an android in high heels. What we are suggesting is that placing reasonable limits on the size, shape, and weight of your machine before it's built can save you and your property needless grief afterwards.

First, decide what temperatures your machine should be prepared to endure, then choose your materials carefully to meet or somewhat exceed those conditions.

A house android, for example, that will never leave the comfort of a heated/air conditioned "room temperature" home, can be built out of the handiest, cheapest materials that will handle the mechanical

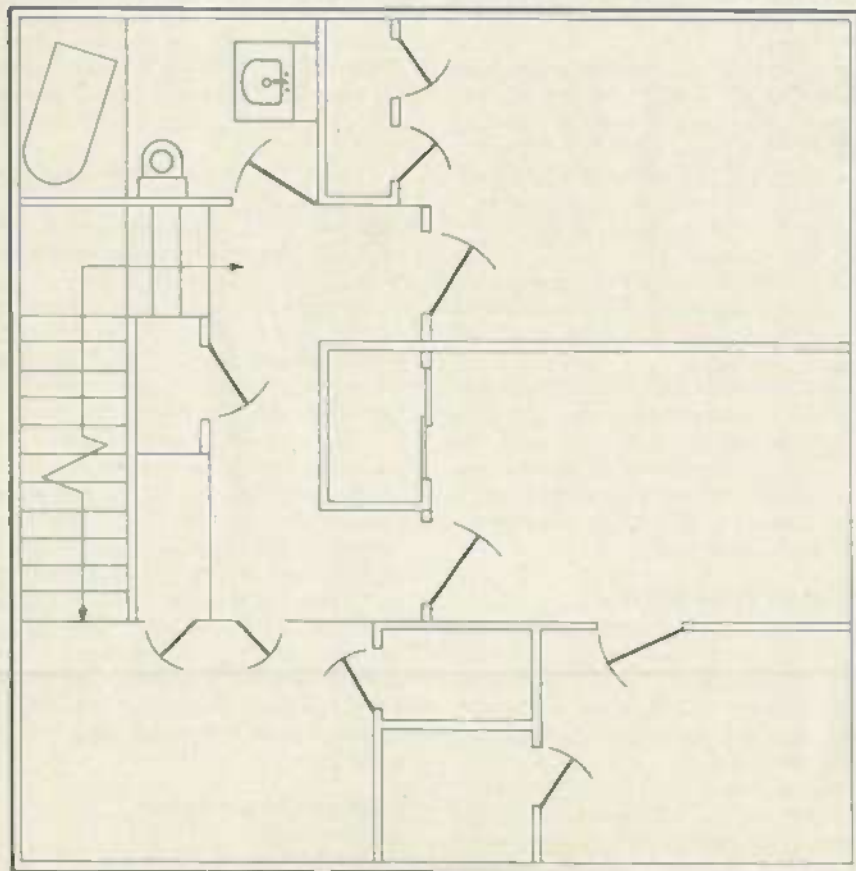

FIG. 1—UPSTAIRS FLOORPLAN of a typical Colonial-style house without the furniture.

and electronic design goals. But if you, for example, take an NMOS or PMOS android outside when it's snowing, you can count on him "forgetting himself" as his electronics will stop functioning. Battery performance is likely to suffer, too, as is mechanical and lubricant performance.

A more generalized machine will be designed for, say,  $-10^{\circ}\text{F}$  to  $100^{\circ}\text{F}$ , depending on your geographic location. CMOS electronics work well to  $-40^{\circ}\text{F}$  ( $= -40^{\circ}\text{C}$ ) and in quite a bit more heat than we can withstand. Those same temperature ranges are readily available for relays, discrete components, motors, lubricants, plastics, adhesives, and most of the other materials we'll need.

### Size and weight

The size and weight of your machine depend very much on the size and weight of your machine; this design loop requires that you force yourself to make some initial assumptions.

For reasons we'll discuss later, practical power and motor design options reduce to electric rechargeable batteries and electric motors. The biggest current requirement for the batteries—by far—is the motor drive. The current required is a function of the power required from the motors, which is a function of the *product* of load and speed.

Obviously, the same amount of power is required to move a machine half as heavy twice as fast as is needed to move a

machine twice as heavy half as fast.

So first we must decide on the total load we would ever want to carry and the minimum speed we would settle for; or we could consider the top speed we wish to attain and settle on the minimum load we want to carry at that speed.

We will present the math later; right now, a few examples are in order.

A machine with a design weight, unloaded, of 100 pounds, designed to travel at a top speed of 20 miles per hour, or to carry a 300 pound load at 5 mph, requires  $5\frac{1}{2}$  horsepower or 4500 Watts. That means 375 amps of stall current from a 12-volt battery.

A reasonable battery configuration, permitting several hours of operation be-

### SOURCES

The following is a list of places to go for more information about robots, androids, and some of the hardware discussed in the article:

**Tab Books** (Blue Ridge Summit, PA 17214) offers two books of interest. *Build Your Own Working Robot* by David L. Heiserman (Tab No. 841, \$5.95) details the construction of a small, wheeled self-controlling vehicle. *The Complete Handbook of Robotics* by Edward L. Safford, Jr. (Tab No. 1071, \$7.95) includes excellent discussions of batteries, motors, sensors and more.

**Hayden Books** (50 Essex Street, Rochelle Park, NJ 07862) offers *How to Build a Computer Controlled Robot* by Tod Looftbourrow (No. 5681-8, \$7.95), which details the hardware and software design of Tod's small robot. "Mike" Hayden also offers the accompanying KIM 6502 software on cassette.

**The International Institute for Robotics** (PO Box 615, Pelahatchie, MS 39145) publishes a newsletter and offers a home study course, which includes a microcomputer and parts for a small machine. The basic course costs \$890. Subscriptions to the newsletter are \$8 annually. Contact Director T. Dale Cowser for information.

**The United States Robotics Society** (PO Box 26484, Albuquerque, NM 87125) acts as a clearinghouse for robotics information and regularly publishes a very worthwhile newsletter. Membership is \$14 a year. Contact Director Glenn Norris for information.

**Gallaher Research** (PO Box 10767, Salem Station, Winston-Salem, NC 27108), or GRI, are the people who introduced the "Grivet" robot arm. They have a three-ring binder (with *Robotics* in big letters on the front and spine) full of sketches and specifications of manipulator systems. That binder, available for \$10, serves as the company catalog of plans, kits and components for manipulator assemblies and machined parts. Contact John K. Gallaher, Jr.

**Lour Control** (1822 Largo Court, Schaumburg, IL 60194) offers a manual for \$15 which details construction of a small wheeled vehicle, sans intelligence. A kit version is available for \$375, an

assembled version for \$495, and an assembled control interface for \$35.

**Micro Works** (PO Box 1110, Del Mar, CA 92014) offers a series of video digitizers that make standard camera video inputs X-Y addressable and extractable for S-100, S-50, and Apple systems.

**Semionics Associates** (41 Tunnel Road, Berkeley, CA 94705) offer content-addressable add-in associative memory (CAM) for the S-100 bus, very useful for pattern recognition.

**Computalk** Consultants (1730 21st Street, Santa Monica, CA 90404) offers speech synthesis hardware and software, and is rumored to be close to introducing speech recognition products.

**Telesensory Systems, Inc.** (3408 Hillview Avenue, P.O. Box 10099, Palo Alto, CA 94304) offers some limited-vocabulary speech synthesis hardware.

**Votrax** (500 Stephenson Highway, Troy, MI 48084) is another manufacturer of software-variable electronically synthesized human speech hardware. Their newest version, VS-6.4, is supposed to represent several improvements over earlier offerings.

**Texas Instruments** (Consumer Specialty Products Division, Lubbock, TX) offers *Speak & Spell*<sup>TM</sup>, an extraordinary talking toy (about \$55 in department stores), and has recently announced a talking language translator. The enterprising experimenter who isn't afraid to cannibalize a *Speak & Spell* can find a thorough explanation of the operation of that chip in the article "Speech Synthesis with Linear Predictive Coding" written by TI's Larry Brantingham and appearing in the June, 1979 issue of *Interface Age*.

**National Semiconductor** is rumored to be working on a single-chip speech synthesizer but details are not yet available.

**Terrepin, Inc.** (33 Edinborough Street, 6th Floor, Boston, MA 02111) offers a small, externally controllable vehicle it calls a "Turtle" robot as a \$400 kit or a \$600 assembly, with an S-100 interface also available.

**Superior Electric** (383 Middle Street, Bristol, CT 06010) offers two 15-minute audio cassette courses for \$5 each. Tape No. 1 is "Stepping Motor Con-

trols;" the other, unnumbered, is "Stepping Motor Technology." The company has a great deal of excellent literature available concerning DC stepping motors.

**Intersil** (10710 North Tantau Avenue, Cupertino, CA 95014) has a number of applicable products. Foremost among those are their CMOS RAM's, EPROM's, and processors, including upcoming CMOS equivalents of the 8048, 8748, 8031 family. Also noteworthy is their IH8510/8520/8530 family of power amplifier, motor and actuator drivers. Application/data sheets and a list of distributors should be available on request.

**Robert Bosch Corporation** (2800 South 25th Ave., Broadview, IL 60153) offers Mini-Giants<sup>®</sup>, a line of small-size low-voltage relays with up to 30-amp contact ratings.

**Globe-Union** (5757 North Green Bay Avenue, Milwaukee, WI 53201) has an excellent brochure available describing their Gel/Cell<sup>®</sup> rechargeable batteries and chargers.

Of all the small computer system-oriented publications, *Byte* (70 Main Street, Peterborough, NH 03458) has had the consistently best coverage of robotics. Here's just a sampling: *Designing a Robot from Nature: A Hobbyist Robot Arm; A Stepping Motor Primer; A Model of the Brain for Robot Control; The Nature of Robots; Talk to a TURTLE; and Artificial Intelligence and Entropy*. All from three selected 1979 issues.

**Arctic Cat** may be a reasonable source for track drive components. Detail exactly what you have in mind in a letter to Peg Kirk, Product Distribution, Arctic Cat Division, Box 635, Thief River Falls, MN 58701. We will try to coordinate a standard kit of components for the kind of track drive described in the text, but that may take a while or forever to define and determine a price for. If and when we're successful, it will be announced in the pages of *Radio-Electronics*.

You may also find useful components in the pages of the *Edmund Scientific* catalog. For a copy, write to them at 7977 Edscorp Building, Barrington, NJ 08007.

tween recharges, involves four 17-pound batteries. But once we add in the weight of motors, mechanics, housings, etc., we can see that we've exceeded our 100-pound weight criterion.

So what must give way? Probably the top unloaded speed and the load carrying requirements. If we cut the top speed to 10 mph and the top loaded weight to 200 pounds (100 pound machine + 100 pound load), we eliminate two batteries, saving 34 pounds—plus trimming weight from the motors, supports, on-board charger, and more. We also lighten up the current requirements for the control electronics.

So by sacrificing the capability of giving us a ride around the block, we see we can build quite a lot of more important capability into a 50-150 pound machine.

But before continuing with our discussion of the physical attributes of our machine, let's go back to a definition of what we want it to do.

### The manipulative imperative

There is a toy on the market, a "Radio-Controlled R2-D2." It's cute, and you really can remote control its motion and direction. Indeed, a number of hobby computer enthusiasts have taken to using their computers to push the buttons. But that toy, on however grand a scale, fails to meet our definition for robot or android because it cannot "manipulate objects external to itself."

That requirement also means that our machine must be designed to *reach* those "objects external to itself" with some sort of mechanical arm. In theory, this mechanical arm requires only three *degrees of freedom*, along the X, Y, and Z perpendicular axes. In practice, however, our rule that the machine must not destroy things in its environment demands the ability to reach around obstacles; that means we must have five or six degrees of freedom.

We get the number of those "degrees of freedom" by counting each "axis of movement"—more simply, each joint. For example, in a human being, the wrist represents one such axis (rotational), the elbow two (both rotational and hinge), the shoulder two. If you add in the hand-wrist hinge action, and all the degrees of freedom in the fingers, you can begin to appreciate the complexity of following an anthropomorphic design.

Another available degree of freedom is telescopic, as is found in the large industrial robots.

A great deal of work has gone into the design of manipulator arms. Those used in industry are out of our scope because of size and cost. But there are others.

Most notable of those is the "Grivet," once (but no longer) offered by Gallaher Research Incorporated for something around four hundred dollars. It used six DC motors and a wealth of machined parts. But it wasn't very sturdy, nor nim-

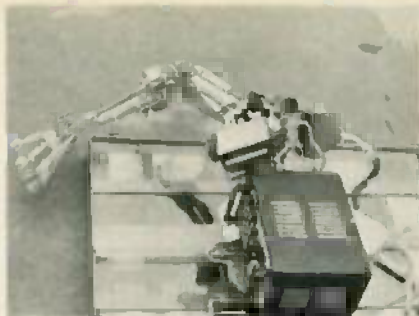

MANIPULATOR ARM, called NELOC, is an innovative design by Andy Filo of Akron, OH.

ble, nor strong. Gallaher is still in business, though, offering optimistic plans, kits, and parts for a number of other manipulators with varying sizes and degrees of freedom. Their catalog, which includes some plans, comes in a handsome 3-ring binder that reads "Robotics 1979" for \$10 (send to GRI at PO Box 10767, Salem Station, Winston-Salem, North Carolina 27108).

### Arm design problems

Some sort of position information will need to be sent back to the controlling intelligence, as well as contact information for the "fingertips"; that requires additional components—at the minimum, a potentiometer for each motor and pressure sensors for the fingertips.

As the weight of the arm rises, so does the necessity of providing counterbalancing weights at each axis, as well as the requirement for structural sturdiness.

Yet, for all of its required strength, the arm has to be able to "give" if it is to survive the shock of a substantial load, suddenly applied. Even the task of catching a football can destroy a too-rigid arm; shock-absorbers must be built in.

Then there's the problem of knowing *where* the arm is, both in relationship to the body of the machine and in relationship to the object that's to be manipulated.

One special task we can anticipate requiring the arm to accomplish involves inserting the on-board battery charger plug into an available wall socket. While the on-board memory can recall the relative position of the plug as a head start, and while the on-board intelligence may have mapped the particular room the machine is in, giving the locations of available outlets, there still remains the problem of lining the plug up exactly with the socket and inserting it—without pushing it through the wall or applying 110 Volts to the shell of the machine.

For that task, there is no substitute for vision.

Next month we will continue this absorbing story with discussions of how an android sees, how it gets about and how it overcomes such obstacles as stairways and tight corners. R-E

# BUILD THIS

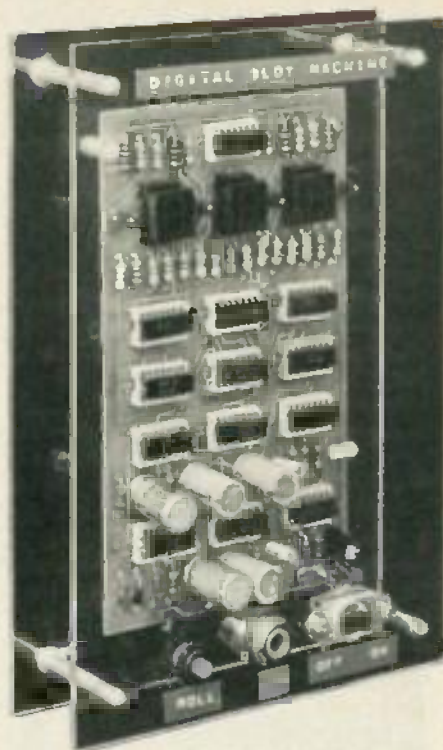

FRED BLECHMAN, K6UGT and DAVID MCDONALD

"ONE-ARMED BANDITS" ARE THE MAINSTAY of gambling centers wherever games of chance are allowed. Go to any hotel lobby in Las Vegas or Reno, for example, and people are pulling the slot machine handles all night. The typical mechanical devices, with three or more rolling drums that randomly stop, are being replaced with microprocessor based video units that feature color graphics and highly sophisticated scoring.

This unit is not that involved. It is an all-electronic design using TTL digital logic, with a set of four LED's programmed to flash on and off when all three characters are the same, indicating a jackpot!

When the power is first applied to the unit, all three displays (usually) light up with the letter "C" (for Cherry), and four discrete LED's flash on and off. (If the LED's don't flash, it's because the three displays did not start up the same—usually they do, but sometimes they don't.) Now press the ROLL pushbutton. The digits will "roll", looking something like a blinking 8, until you release the pushbutton. Now the left-most digit stops, followed shortly thereafter by the center digit, then the last digit. Each digit will display either a "C" for Cherry, an "L" for Lemon, an "O" for Orange or an "A" for Apple. If all three displays stop with the same letter, the LED's flash.

# DIGITAL SLOT MACHINE

*Games of chance and mechanical gambling devices were with us for years, then came electric and now electronic games. Here is a simple electronic version of the one-armed-bandit that you can build.*

The odds of getting all three displays with any of the four same letters are 1 in 16 tries. For any two displays to have the same letter in selected locations, the odds are also 1 in 16. The odds of getting the same selected letter in all three displays is one chance in 64.

## How it works

This explanation will assume you have some knowledge of digital circuitry. Figure 1 is a block diagram of the Digital Slot Machine and Fig. 2 shows the schematic. Each display has its own logic section that is clocked by a separate oscillator. The WIN logic section monitors the state of each display, and when all three are the same, it commands the LED's to flash on and off at a rate determined by the WIN oscillator.

Let's describe how display 1 is operated, since the same technique is used for display 2 and display 3 (with small differences described later).

## Clocking

Inverters IC13-a and IC13-b, together with resistors R22 and R23 and paralleled capacitors C1, C2 and C3, form the oscillator 1 circuit. The output of this oscillator is applied to one input (pin 10) of NAND Schmitt trigger IC12-a.

When pushbutton switch S1 is depressed, capacitor C4 immediately charges through blocking diode D1, and a positive voltage appears on pin 9 of the Schmitt trigger IC12-a. Now whenever

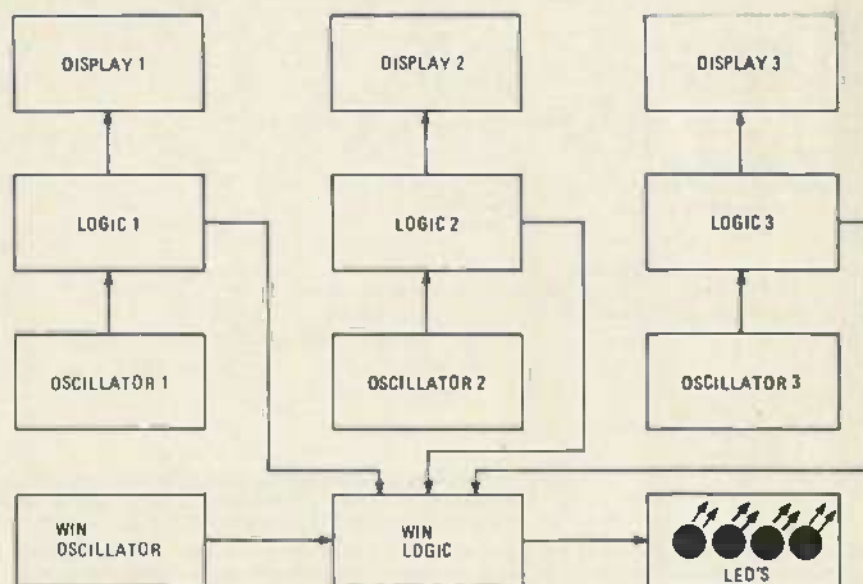

FIG. 1—BLOCK DIAGRAM of the digital slot machine. Each display is "rolled" by a separate oscillator. The "win" oscillator blinks the four LED's when the three displays are identical.

the output of oscillator 1 (IC13-a & IC13-b) is HI, pin 8 of IC12-a, which is normally HI, snaps LO and clocks flip-flop IC5-b at its pin-5 input. The Q and  $\bar{Q}$  outputs of IC5-b, pins 8 and 9, change state each time a LO clock pulse comes from IC12-a.

When S1 is released, C4 discharges through resistor R24 until the input to IC12-a at pin 9 falls below threshold to a LO, so the output of IC12-a is held HI and no further clocking occurs, even though oscillator 1 is still running.

The snap-action Schmitt trigger is used here rather than a normal NAND gate so the slow decay time of C4/R24 doesn't cause erratic operation and false triggering.

## Display Logic

When power switch S2 is closed, flip-flops IC5-a and IC5-b usually come up to voltage with a logic LO on the Q output of IC5-a, and a logic HI on the Q output of IC5-b. Figure 3 shows the logic states at the inputs and outputs of each

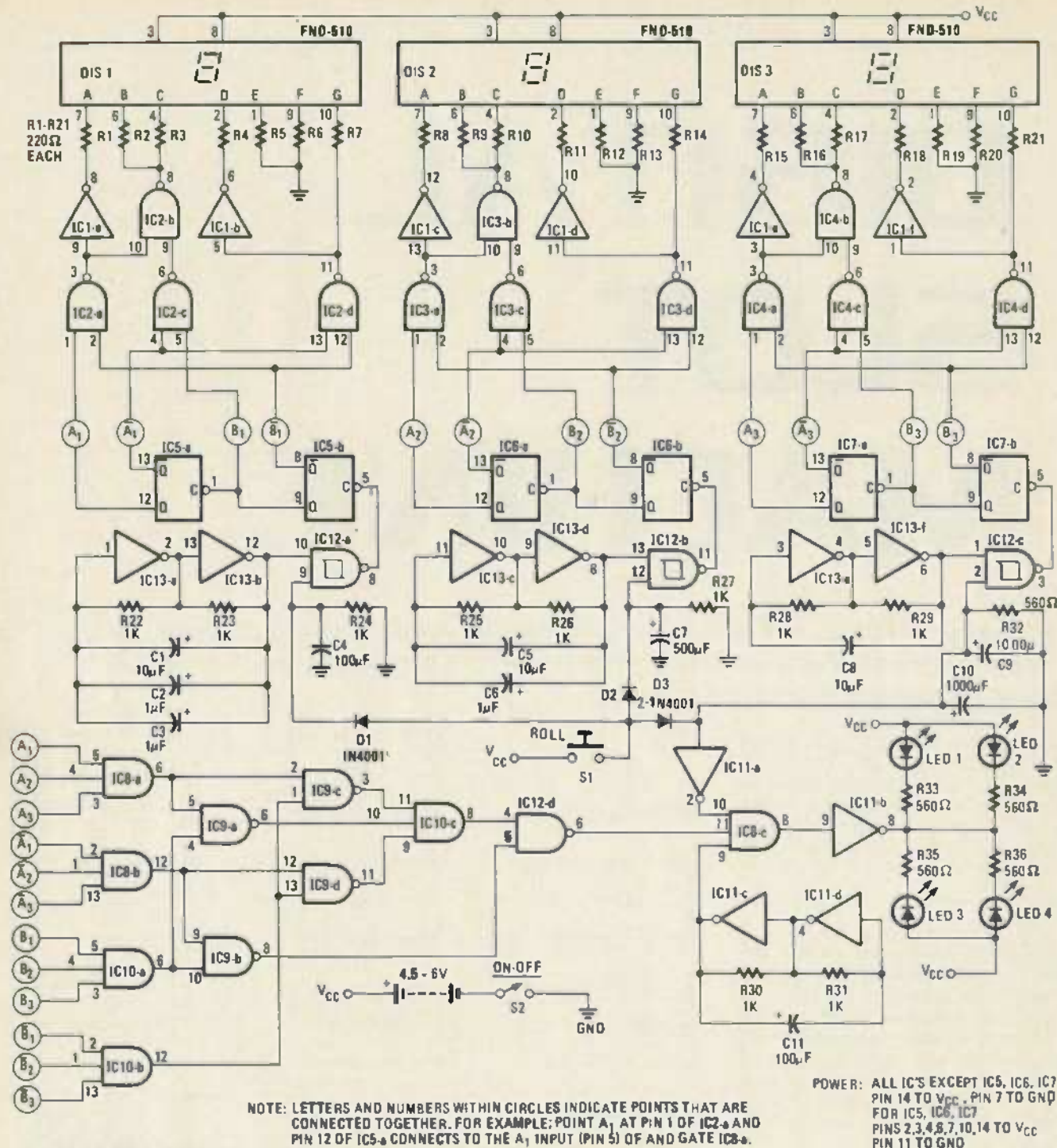

**FIG. 2—SCHEMATIC DIAGRAM** of the digital electronic slot machine. Each of the three displays will show a random selection of the letters A, C, L and O; representing apple, cherry, lemon and orange, respectively.

logic element. This results in a display of the letter "C". All display segments have a series resistor to prevent burnout, since these are LED displays. Display segments E and F are always lighted since they are wired to ground through their resistors R5 and R6. A logic LO at the output of inverter IC1-a allows segment A to light, and the LO at the output of inverter IC1-b lights segment D. The logic HI at the output of NAND gate IC2-b keeps segments B and C off, while the HI at the output of IC2-d keeps segment G off.

When the pushbutton switch is de-

pressed and the first LO clocking pulse arrives at the input of flip-flop IC5-b, its outputs change state: Q goes LO and Q-bar goes HI. As the Q output of IC5-b goes LO, this also clocks flip-flop IC5-a, driving its output HI and the Q-bar output LO. If you follow the changes through the display logic network, you'll find only one segment is effected; segment A goes off, so the "C" becomes an "L".

When the next LO arrives from the oscillator, flip-flop IC5-b outputs change state again. Output Q goes HI, and output Q-bar goes LO. However—and this is

important—flip-flop IC5-a does NOT change state, since it needs a logic LO at its clock input, and it just received a HI! Thus, flip-flop IC5-a is counting in binary, only changing state with every *second* cycle of the oscillator. This is the way binary counters operate.

The display changes from "C" to "L" to "O" to "A" and then repeats as long as S1 is pressed. When S1 is released the decay time of C4/R24 allows the display to keep changing for a short time, finally stopping at one of the four letters.

The logic networks for the other two

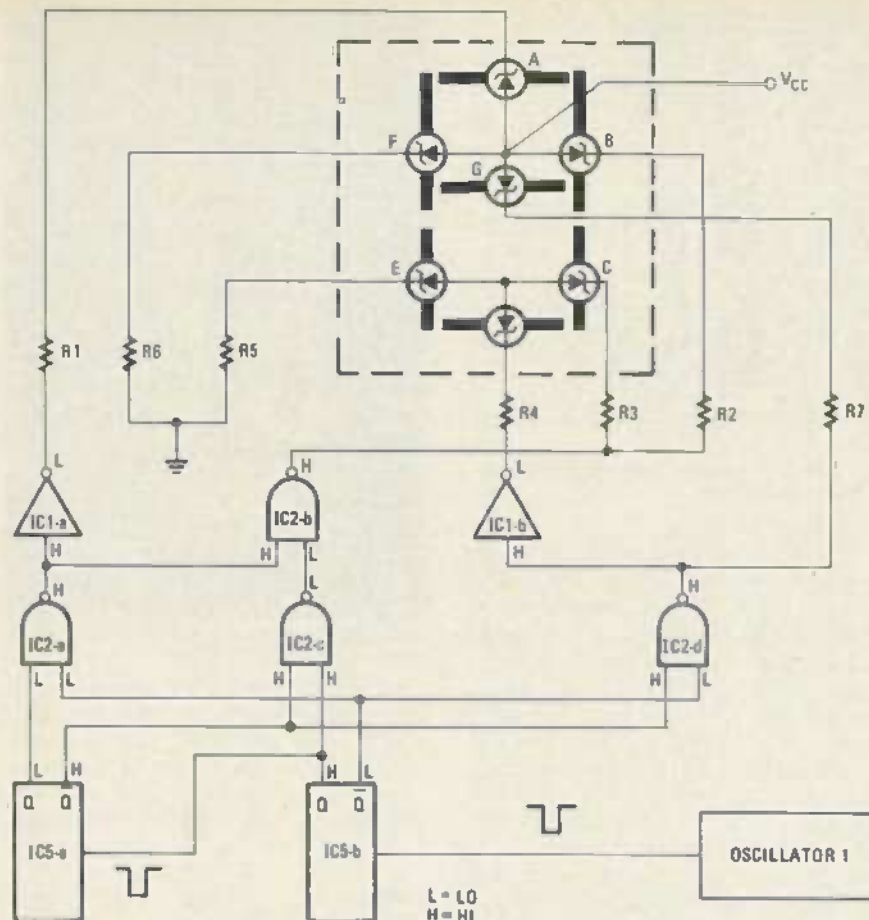

FIG. 3—DISPLAY LOGIC DIAGRAM shows the existing states of pertinent points when the letter C—for cherry, is displayed.

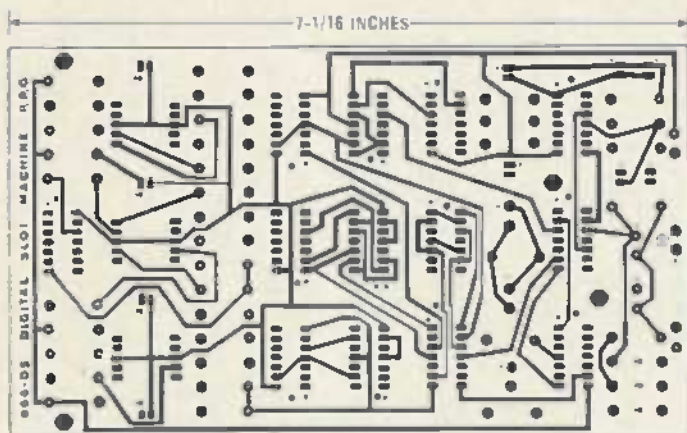

FIG. 4—FOIL PATTERN for the top surface of the PC board. The double-sided feature Cells for precise alignment of the top and bottom foil patterns.

letter displays are identical. The oscillator speeds are slightly different. Oscillator 1 has a total of  $12\mu\text{F}$  (C1 plus C2 plus C3) while oscillator 2 has  $11\mu\text{F}$  (C5 plus C6) and oscillator 3 has  $10\mu\text{F}$  (C8). The lower the capacitance the higher the output frequency and the faster the display changes letters. This speed difference provides a more random result to the displays. Also, each display has a different stopping time. The oscillator for each display can only feed pulses through the Schmitt trigger to the flip-flop as long as the voltage on one trigger input pin is held HI (pin 9 of IC12-a, for example). For display 1 this is controlled, after the release

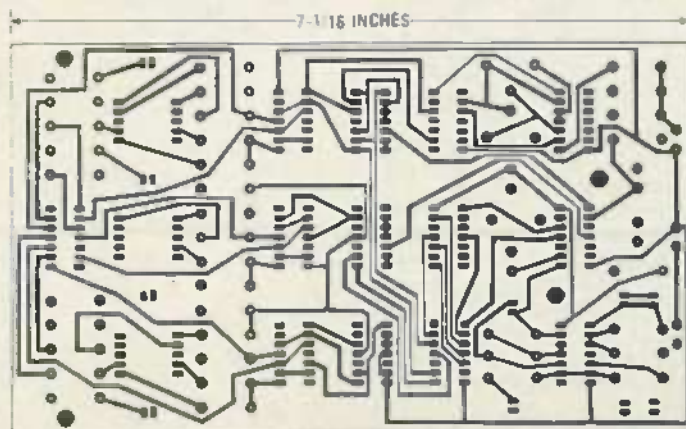

FIG. 5—PATTERN for the bottom of the PC board. See text on the plated-through holes.

of S1, by C4 and R24 with a relatively short time constant. For display 2, however, C7 is five times the value of C4, and for display 3 the combination of C9 and C10 is four times greater than C7. Even though bleeder resistor R32 is a lower value than R24 or R27, the results are that display 1 stops almost immediately after S1 is released, followed shortly by display 2, and then display 3 a little bit later. This creates suspense and virtually guarantees a random combination.

#### WIN Logic

When each display is identical, the output states of each pair of flip-flops (IC5-a and -b, IC6-a and -b, IC7-a and -b) are also identical. The schematic shows each of the flip-flop outputs are designated A1, A1, B1, B1, etc. If all three displays are *not* identical, the logic network composed of IC8-a, IC8-b, IC10-a, IC10-b, IC9-a, IC9-b, IC9-c, IC9-d and IC10-c holds output pin 6 of Schmitt trigger IC12-d LO. However, whenever any of the 4 possible combinations of identical outputs appears at each flip-flop set, the output of IC12-d goes HI.

Looking at AND gate IC8-c, we see three inputs. One input (pin 11) is from IC12-d, pin 6 as just described. Another input (pin 9) is from pin 6 of inverter IC11-a. Inverters IC11-c and -d, together with R30, R31, and C11, form an oscillator running at a slow speed—about 4 Hz. This is the "WIN" oscillator. The third input to IC8-c at pin 10, is from inverter IC11-a. Obviously, whenever pushbutton switch S1 is pressed, a HI appears at input pin 1 to IC11-a, through blocking diode D3. However, when S1 is released, the HI at pin 1 of IC11-a is maintained by the decaying voltage across the parallel combination of C9 and C10, with bleeder resistor R32 controlling the decay time. When this voltage falls below threshold, Schmitt trigger IC12-c no longer enables oscillator 3 pulses, so the display "freezes." Also, the input to IC11-a is now LO, so its output goes HI. This tells AND gate IC8-c that the last display has stopped, and thus prevents the four WIN LED's from flashing spuriously anytime the displays happen to be identical.

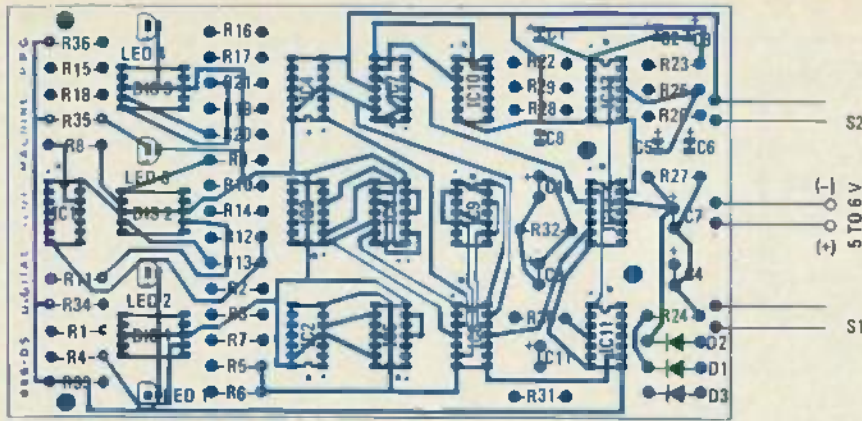

FIG. 6—NOW PARTS ARE positioned on the PC board. Note the polarity of the capacitors and diodes. IC's 2-7 are inserted facing down while IC's 1 through 13 face up.

Now we can see that three conditions must exist for pin 8 of AND gate IC8-c to output a HI: (1) the three displays must be the same (IC12-d's output HI); (2) the WIN oscillator must be providing a HI and (3) S1 must be open and the last display stopped.

When these three conditions exist, the output of AND gate IC8-c is HI and the input to inverter IC11-b is HI. The output of IC11-b goes LO and the cathodes of all four LED's see a path to ground and light. As the WIN oscillator output goes LO, AND gate IC8-c output goes LO, the output of IC11-b goes HI and the LED's go off. This sequence continues at a rate of about 4 times per second (WIN oscillator frequency) until either S1 is pressed again, or power is turned off.

#### PARTS LIST

All capacitors 10 volts or higher rating;

all resistors 1/2 watt carbon 10%

- R1—R21 220 ohms
- R22—R31 1000 ohms
- R32—R36 560 ohms
- C1, C5, C8 10 $\mu$ F electrolytic
- C2, C3, C6 1 $\mu$ F electrolytic
- C4, C11 100 $\mu$ F electrolytic
- C7 500 $\mu$ F electrolytic
- C9, C10 1000 $\mu$ F electrolytic
- D1, D2, D3 1N4001 or equiv. (1A, 50 PIV)
- LED1—LED4 Jumbo red LED
- DIS1—DIS3 Fairchild FND 510 .5 inch common-anode 7-segment display
- IC1, IC11, IC13 7404 hex inverter
- IC2, IC3, IC4, IC9 7400 quad 2-input NAND gates
- IC5, IC6, IC7 7473 dual J-K flip-flop
- IC8, IC10 7411 triple 3-input AND gate
- IC12 74132 quad 2-input NAND Schmitt trigger
- S1 SPST normally-open pushbutton switch
- S2 SPST slide switch

A complete kit of all parts above, plus a double-sided drilled printed-circuit board with plated-through holes, is available for \$29.95. The PC board alone is \$10.95. Add \$1 for shipping (USA) and handling. California residents add 6% sales tax. Order from:  
 PPG Electronics Co., Inc. Dept. RE  
 14725 Oxnard St.,  
 Van Nuys, CA 91401

#### Construction

The Parts List shows that this design uses a lot of parts, including 13 integrated circuits. While you could certainly wire this on a perforated board, it is far easier and less troublesome to use a printed circuit board. Figures 4 and 5 show the top and bottom of a two-sided PC board design. If you make this board yourself, be certain that the top and bottom traces are aligned very closely. Since you probably won't have the equipment to plate through the holes after you drill them, be sure to solder each component on both the top and bottom of the board wherever traces would feed through. This might mean using Molex pins instead of sockets for the IC's since the pins can be soldered to both the top and bottom of the board, while regular IC sockets can only be soldered to the bottom of the board.

The actual construction is very simple if you use the PC layout shown, with only a few precautions. Insert all parts into the top of the board in the positions shown in Fig. 6. Use sockets for all IC's—just in case you insert the IC's backwards (see Fig. 7 for orientation), or if an IC ever needs to be replaced for any reason. Be sure all capacitors are inserted into the board with the proper polarity; the same is true for the diodes and LED's. For the

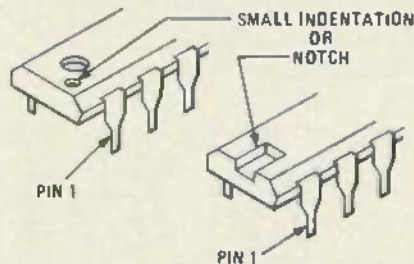

FIG. 7—HOW PIN 1 IS IDENTIFIED on an IC housed in a DIP package.

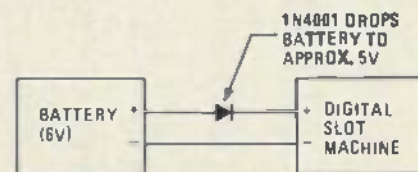
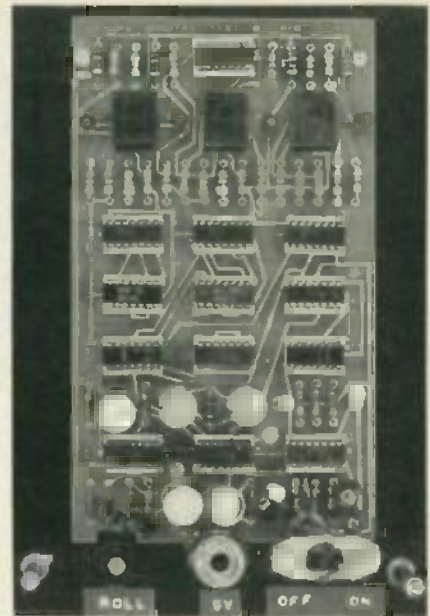

FIG. 8—DROPPING DIODE protects against reversed polarity.



FRONT VIEW of the slot machine. Clear plastic panel makes all parts visible.

diode, the banded end is your guide; for the LED, look for a flat spot or notch at the base. Be particularly careful to note that the top edge of the displays have 4 notches along that side. Be very careful to put the right valued resistor in each location.

#### Testing

Use either 4 "D" cells, a 6-volt lantern battery or a 5-volt regulated supply for power. **DO NOT** reverse polarity or you'll probably zap the IC's! It would be wise, actually, to add a diode (1N4001 or equivalent) in series with the power supply lead (see Fig. 8), especially if you're using batteries. With the diode, the 6 volts from the lantern battery is dropped closer to the ideal 5 volts for TTL circuitry. (If the display is dim or erratic, jump or remove the diode you added.)

Turn on S2. The displays should all light. If all three are the same, the four LED's should flash. Troubles can usually be traced to (1) poor soldering (2) parts in backwards, for those requiring proper orientation, (3) component values in wrong locations. Actually, the *least* likely problem is defective parts, so check (1) to (3) above before blaming the parts.

Press S1 and watch the action!

#### Modifications and packaging

The entire unit could be packaged in a large box, but my model is sandwiched between sheets of clear Plexiglas with screws and spacers, with the switches and power jack mounted on the upper panel.

You might want to increase the stopping time of the displays, to add to the suspense. This is most easily done by adding capacitance to each display's slow-down circuit—C4, C7 or C9/C10.

While the Digital Slot Machine won't allow you to go home with a pocket full of silver dollars, at least you'll still have the shirt on your back!

R-E



# Identify Unmarked IC's

*How to identify those surplus and salvageable IC's and reduce the cost of your next digital construction project.*

KIRTLAND H. OLSON, P.E. & ANN L. ZEVIK\*

SOME TIME OR OTHER, EVERY ELECTRONICS buff gets hooked on at least one super deal for unmarked components. Though I generally shy away from such "bargains" as too time-consuming, I fell into this one by making an all-too-common mistake.

It began when a neighbor introduced me to a new surplus outlet operated by a local manufacturer. On my first visit, I looked at many circuit boards, filled with IC's, and marveled at the low prices. Memorizing a few numbers and codes, I resolved to see if any data sheets in my files would reveal information on those boards.

Success! Some numbers seemed familiar — 911, 914, 912 seemed to belong to a resistor-transistor logic family (RTL) introduced some years ago by Fairchild. Symbols that I remembered from the packages told me that Fairchild, Motorola, and Transiltron had manufactured those circuits. Although I had no specific data sheets, my collection revealed that RTL had been made in dual-inline packages (DIP's) like those I'd seen.

I resolved to buy some boards on my next visit, and parted with a few dollars for several. Hedging my bet, I chose those containing discrete components as well as integrated circuits. That way, if the IC's were valueless, I could at least salvage a reasonable number of resistors and capacitors. Tucking my prize behind the seat, I drove home, elated.

After several days of poring over data sheets, and back issues of *Radio-Electronics*, my collection of diagrams, pin-connections, and type numbers filled several sheets of notes; but discrepancies began to arise. Some numbers had four digits that didn't appear in any logic family; other numbers suggested linear circuits.

Such was my introduction to *date codes*: The numbers that guided my purchase turned out to be manufacturing dates. Crushed, I put the boards aside for several months. From time to time I contemplated attempts at identification.

Now almost a year after my original purchase, I wanted some IC gates and decided to try to identify some of those unmarked units experimentally. Although I ultimately succeeded, frustrating failures dogged my path. However, each failure taught me valuable lessons from which I derived a scheme for identifying unmarked digital IC's.

### Hooking up the power supply

I started by trying to identify IC elements that would clearly indicate a logic family. Still believing that the DIP's contained RTL, I expected to use a 3.6-volt power supply; but I still needed to know which pins to try. Several pin-pairs commonly serve as power and ground — 7 and 14 often serve TTL DIP's — but RTL uses 4 and 11.

For most digital logic families, you can connect any pin to a positive supply or ground without damage. However, *some* power gates would not survive that, if you



**BEST BUY BOARD.** This single-sided board contains both IC's and discrete components. Electrolytic capacitors indicate voltage limits and polarity. The Zener diode also tells us the voltage and polarity.

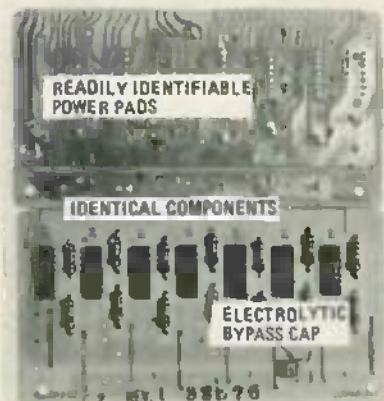

**ANOTHER GOOD BOARD CHOICE.** Electrolytic bypass capacitor tells us polarity and maximum power line voltage.

\*Kirtland H. Olson, P.E., provides technical and management assistance to business and government. Ann L. Zevnik writes, lectures and manages seminars for The Harvard Group.

happened to connect a collector directly to the supply while the transistor was turned on; and RTL NOR gates might also be damaged. I put 500- to 1000-ohm protective resistors in series with test probes to each side of the supply. Of course, I couldn't put such resistors in series with the power supply, but I was using a diode string (see Fig 1) that could deliver only 50 mA anyway:

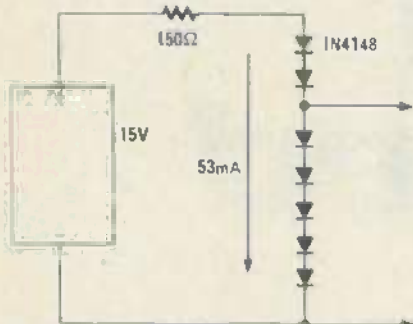

FIG. 1—DIODE STRING in series with resistor acts as a voltage divider. Each diode develops a fixed voltage drop across its junction.

Using printed circuit traces as clues, I saw that pin 4 of all packages connected to a common point. What I took to be pin 11 also returned to a common bus. As leads didn't always go directly, I patiently traced back to the common point on the board. Using RTL specs as a guide, I applied about 4 volts to one DIP after removing it from the board.

Missed again! First, the voltage across the IC was only millivolts and I suspected that the supply was backward. Reversing the leads raised the voltages to more reasonable levels. Past experience told me that I should find gate outputs at definite logic levels, and that inputs would not be so precise.

I began to measure voltages at each pin. The strange results puzzled me; few pins showed anything sensible. I shut down the supply and turned to my notes to check my work.

Idly picking up a board, I checked the pinout again. As I counted the pins, I realized that it was pin 10, not 11, that was common to many IC's. On turning the board over, I spotted an electrolytic bypass cap, clearly marked with + and -. Now I knew the power pins and the correct polarity.

### Identifying the gates

Quickly soldering the power leads to the proper pins, I began to repeat my measurements. As the numbers filled my chart, the gate structure began to reveal itself. On those IC's, some strange voltages appeared. I recorded them without understanding, hoping to find an explanation later. Clearly, however, those voltages didn't look like RTL. Many terminals were near 1.5 volts, suggesting internal pull-up resistors for a current-sinking form of logic.

With the chart filled in, I checked the components near the place I'd removed the IC from the circuit board. Small

capacitors connected the terminals with oddball voltages to others. A cursory check revealed that the circuit boards contained many such caps, connected between pins on the various DIP's.

Two pins showed values essentially equal to the supply voltage, and I took those to be outputs. Since gates are the most common functions, I also assumed that the DIP contained one or more gates of an unknown kind. Deducing that I would most likely find a NAND gate, I put the meter on the output terminal and began to ground each unidentified pin in turn.

I soon discovered four pins that made the assumed output pin go low, when any one was grounded. Moving the meter probe, I found that the pin with the strange voltage behaved logically opposite to the output — but varied between 0.4 and 0.8 volts, rather than between zero and supply. Moving on, I tried the other high voltage pin and found a similar gate structure.

At that point, I wondered how I would identify the proper supply voltage. Capacitor ratings of 15 and 35 volts certainly set an upper limit. Most logic families use five volts, but how could I be certain? Luckily, I found one card with a Zener diode on it, clearly connected to supply the IC's.

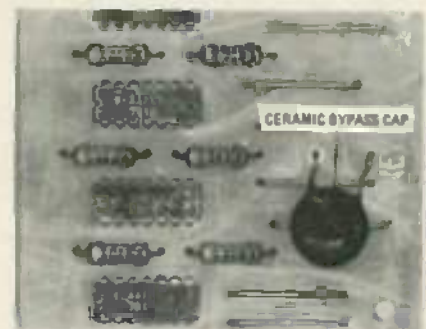

CERAMIC BYPASS CAPACITOR does not indicate polarity or voltage, but does identify power buses.

Measuring the Zener voltage, I verified that those IC's required 5 volts. Remembering my previous mistakes, I decided not to use my 5-volt 1-amp lab supply, but rather to use my + or - 15-volt 200-mA supply with a dropping resistor to limit available current to 50 mA. I used the Zener removed from the board to provide 5 volts.

Rewiring my setup, I re-measured voltages at various IC pins and tested gate-functions thoroughly. Testing all 32,768 combinations of 16 pins would take 9 hours at 1 second per test, so I was glad to have developed some clues first. As a result, even trying to hold five probes at once, I could prove within a half hour that the IC contained two positive logic AND gates, each with four inputs.

Celebrating my victory over a cup of coffee, I reflected on how lucky I had been so far. But luck helps those who are ready: I had balanced my mistakes with

## CHECKLIST FOR TESTING SURPLUS DIGITAL IC'S

1. Use circuit clues to identify power pins, polarity, and voltage, if possible.
2. Sketch the circuit connections to an IC before removing it from the board. Record pins that are grounded, tied to plus, tied together, or left open. That procedure reduces the number of combinations you need to try. Also record the presence of pin-to-pin resistors or capacitors; they often give valuable clues.
3. Measure the supply voltage at the IC pins immediately after firing up the test circuit.
4. Use your voltmeter and grounding probe to group gate inputs together. The open-circuit voltage at one input to a gate drops mV when you ground another input to the same gate.
5. Test one IC at a time until you can identify it.
6. Use a power supply that can only deliver a few mA when shorted.
7. Use a socket mounted to a breadboard. Molex pins on drilled breadboards, or the upside-down socket type, will accept soldered pins.
8. If you don't know the voltage, start at 3.6 to 4 volts. This way you won't kill RTL but will operate DTL/TTL.
9. Make a simple clock pulser so you know you get one clock pulse per actuation.
10. Use 470 ohms to 1k ohms in series, with probes to connect inputs to plus or ground.
11. Once you identify one function, test another mystery IC that has identical markings to see if it is the same function. Then test another with some (not all) markings different. Establish which marks relate to function.
  - Outputs tend to take either the highest or lowest voltages, second only to the power and ground connections.
  - Clock inputs may appear to be grounds when left floating.
  - Normal gate inputs for current sinking logic are 2 to 3 diode drops above ground — that is, 1.2 to 1.8 volts when floating.
  - Voltages differing from the standard logic levels usually indicate nodes, expanders, or special inputs for external components.

good moves. Choosing boards with discrete components gave me clues (like the Zener voltage) that would otherwise have been missing. Using a current-limited supply meant that my mistakes in connecting power were not fatal to the IC, and provided both information and a second chance to use it. Buying IC's on boards gave me circuit clues not available in "by the bagful" specials.

Getting the first IC off the board had been a chore. Lifted pads and bent leads gave mute evidence of trouble to come. Unfortunately, the pads lifted easily from those boards (some kind of paper epoxy, not glass). The manufacturer had bent the IC leads over on the circuit side of the PC board, making removal difficult.

Then I had an inspiration! Realizing that there was no real reason to save the useless board, I decided to cut the traces next to the pads and deliberately lift the pads individually with my soldering iron.

Using a small hobby grinder, I cut each trace as close to the pad as possible. (If you don't have a grinder, use a razor blade or sharp knife to cut the circuit.) Heating the pad until it lifted, I slid the pad off the bent IC pin. With longnose pliers, I straightened each lead and the DIP's fell off the board into my waiting hand.

### Sorting the IC's

Near the date code, the IC's I bought bore cryptic markings consisting of four letters and one number. For example, the first IC I tried was labelled AAAL4. Finding another DIP marked AAAL4 with a different date code, I removed it from the board and proceeded to test the circuit, assuming it would be the same. Within minutes, my assumption was proven correct.

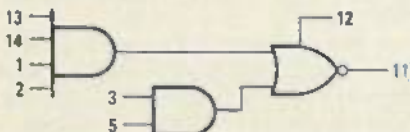

FIG. 2—DEVICE had 2-input and 4-input AND gates feeding a 2-input NOR gate.

Excited by success, I sought a new challenge. A DIP marked AAVL1 seemed less formidable than one marked AAFA1 — suppose that meant "full adder!" Removing the AAVL1 IC, I still marveled at how easily I could remove the circuit trace from the package, rather than trying to wrest the package from the board.

By now I knew that the circuit contained many valuable clues. Accordingly, I made notes to show where the small capacitors connected; which pins were grounded; which connected together, and which had no connection. This time I quickly verified that one of the pins connected to the capacitor was an output, and there were two of them.

Figure 2 shows the diagram as I derived it. Because pin 11 presents a NOR function, I needed more time to

determine its operation. I found it easiest to define those functions for positive logic, since the gate inputs normally assume the high state. Thus, pin 11 of AAVL1 normally stays low if all inputs are open. Grounding 3 or 5, or both, raises 11 *only* if 13, 14, 1, or 2 is also grounded. Later, I learned a way to tell which pins were in the same gate input, but at this point, logic alone sufficed.

Since a V in the identifying numbering sequence occurred when I encountered a NOR function, I resolved to see if AAAL5 numbered device would be only AND gates. Again using circuit board clues, I made my sketch (see Fig 3). The outputs were high and did not respond rapidly to grounding single input pins. Clearly those were not simple AND gates.

Using the meter and the grounding probe, I discovered that some inputs affected others. If the DVM read 1.483

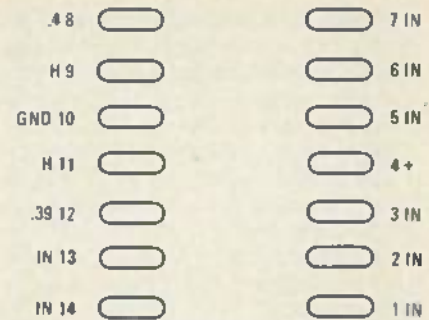

FIG. 3—DEVICE PIN-OUT with identified leads and their functions.

on one input, grounding any one of several other inputs reduced the reading to between 0.9 and 1.1 volts. I had found a way to deduce which inputs entered the same gate! External pin measurements reveal close internal connections. Knowing which inputs comprise the same gates provides the key to unscrambling complicated IC's.

## REMOVING IC'S FROM SURPLUS CIRCUIT BOARDS

Although many manufacturers offer devices to ease IC removal, most of those tools are designed to try and preserve the circuit board. If you recognize that the surplus board is worthless, except to carry home your IC's, there's an easier way to remove DIP's from cards.

The trick is to do the job in steps:

1. Cut the circuit traces, so each pad can be removed separately.

2. Heat the pad with your soldering iron until you can slide it over the bent IC pin.

3. Straighten the IC pins, one by one, so the DIP drops off the board.

That procedure wrecks the board, but separates the de-soldering operation from mechanically removing the IC. DIP's come off easily, with straight, clean pins that will still fit a socket.

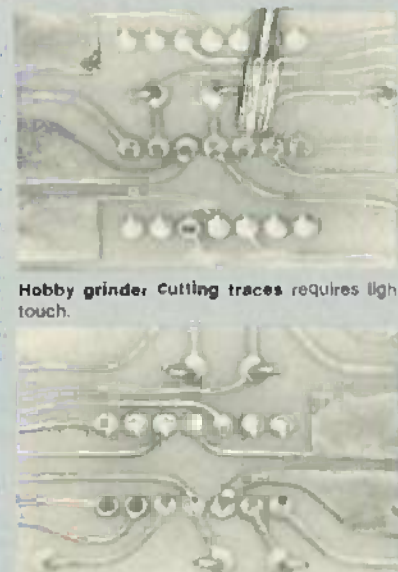

IC before removal, traces and pads intact.



Heat pad with soldering iron, slide off in direction of bent pin.



After removing all pads, straighten each pin with long-nosed pliers.

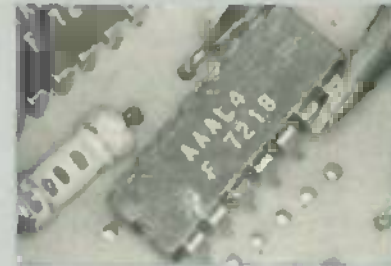

Board is destroyed, but IC drops out with straight, usable pins.



Hopelessly difficult to remove, this IC is entirely grounded.

Rapidly checking each pin against the others, I found four input pairs. Deducing that those pairs further combined inside the gate, I strapped them together and to ground in various combinations until a sensible pattern emerged. In a short while I derived the diagram shown in Fig. 4. That DIP contains two pairs of two-input AND gates followed by the OR INVERT sections. As I'll show you later, you can connect each of those to make an exclusive OR.

My assumption that "V" signified NOR was clearly down the drain. Testing several units of each type, I could verify that the alphanumeric code uniquely identified the device, but still could not deduce the meanings.

### On to other IC's

Confident that I could attack more complex functions, I tried an AAFLI.

### CHECKLIST FOR BUYING SURPLUS DIGITAL IC'S

1. Avoid multilayer boards. They make it hard to get the IC's off without special equipment. (You can tell multilayer boards by holding them up to a light. If you see circuit traces that aren't on either side of the board, it's a multilayer type.)
2. Pick singlesided PC boards whenever possible.
3. Next choose double-sided boards.
4. Choose boards with physical defects (bad solder or cracks) over those with burn marks or other obvious warnings. You are more likely to get good, new materials.
5. Get boards with discrete components—especially Zeners or filter caps—to give you clues to IC voltages and pinout. That way, if the IC's turn out badly, at least you'll salvage some components.
6. Pick boards that have repetitive patterns and many IC's of one kind. They will help you find clock lines, power pins, and essential control lines.
7. Prefer boards with straight IC pins.
8. Pick boards that have the smallest pads around IC pins, making it easier to lift them with a soldering iron. Big solid blocks of circuit are hard to lift.
9. Avoid glass epoxy boards. They hold their pads better, so you must work harder to get the IC's off.
10. Remember that numbers like 911 or 7222 are likely to be date codes unless you see the complete manufacturer's number.

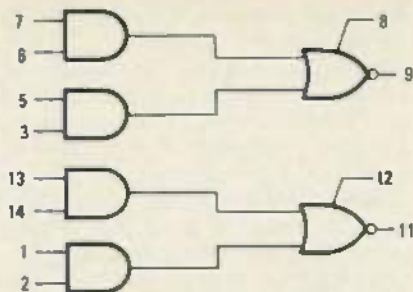

FIG. 4—THIS DEVICE was found to contain two pairs of 2-input AND gates. Each AND-gate pair fed into a 2-input NOR gate.

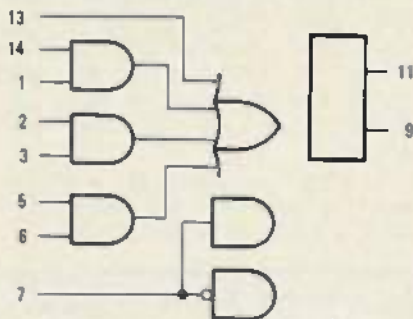

FIG. 5—LOGIC DIAGRAM of the IC before all lead connections and functions had been identified and labeled.

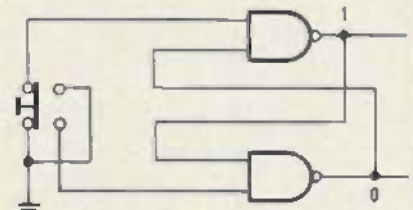

FIG. 6—TWO NAND GATES connected as a switch-operated clock that produces a single pulse each time switch is pressed.

Once again I found two outputs, and established the pairs of gates. As I measured one output, grounding inputs in turn, I got very confusing results. I could swear that the output state changed, but repeating the test showed no result.

After going through several such sequences, I began to measure both outputs after each test. Suddenly it was clear—feedback points always changed in synchronism. That revelation opened new possibilities to explore. Although more complex functions could give the observed changes, I deduced that AAFLI contained flip-flops.

Checking that assumption, I found that pin 7 on AAFLI seemed to be connected to ground internally: it always remained within a few millivolts of ground. I decided to seek circuit board clues. Finding a board containing only AAFLI devices, I discovered that all pins 7 were bussed to conductors that left the board. Furthermore, by examining the other connections around AAFLI devices, I surmised that of the inputs, only pins 13 and 1 could not be simply tied to ground.

Let's review the situation, because flip-flops are a little harder than simple gates. Figure 5 shows what I knew before using circuit board clues. Bussing of pin 7 indicates some common purpose, and its

normally low voltage (when unconnected) sets it apart from common gate inputs. Of the remaining terminals, 9 and 11 are outputs; 8 and 12 are the corresponding feedback points for capacitors; 4 is the positive supply, and 10 is ground. Circuit board traces always take 13 and 1 to the connector; 14 is sometimes used and sometimes open, and 2, 3, 5, and 6 connect to ground.

Piecing all that together, I opted to strap 2, 3, 5, and 6 to ground, leave 14 open, work with 13 and 1, and assume that 7 was the clock. At first, I tried clocking the flip-flop with a probe, connecting alternately to +5 and ground. That set-up turned out to be unreliable, as the imperfect contact generates an unknown number of pulses. Figure 6 shows a simple, switch-operated clock that produces a single clock pulse each time we operate the snap-action switch.

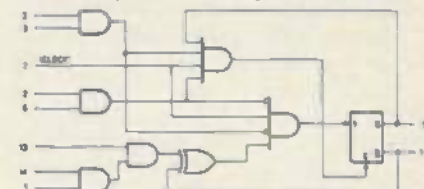

FIG. 7—EXCLUSIVE-OR made from two AND gates and NOR gate in half of AAALS.

Using a similar clock generator, I could cycle the clock line for varying combinations of logical inputs to pins 13 and 1.

### Tables of inputs & outputs

By reducing the number of terminals to be tested, I generated simple tables relating the logical inputs and outputs before clocking to the logic outputs after a clock cycle. Having then a guide to operation, I could alter the state of pins 2, 3, 5, and 6 in various combinations and derive a logic representation of the flip-flop.

Using the functional diagrams I developed, I built a seven-stage feedback shift register that generates 125 of all 127 possible sequences of 7 bits. In essence it makes digital noise. I used an AAALS as an exclusive OR (Fig. 7) to feed back signals from the last two stages of the shift register to the first.

As you can see from Fig. 7, the AND gates form the functions  $A.B'$  and  $B.A'$  before being OR'ed and inverted. Thus they provide an output only if one flip-flop is high and *not* when both are high. That generates the exclusive OR function.

Now, I realize that your unmarked or house-numbered IC's will be coded differently from the ones I bought. But with simple equipment and careful measurements, you can identify digital IC's precisely enough to use them for many projects. Buying carefully will help you to gain many hints for the solution of your particular puzzle.

Use the three checklists on buying and testing surplus digital IC's to help yourself to bargain components. R-E

# CONFERENCE CALL Telephone Accessory

*Have you ever wished that you could converse via telephone with two separate parties at the same time? If so, it is possible that you can do it using this inexpensive and easy-to-build telephone adapter.*

JULES H. GILDER

WOULD YOU LIKE TO BE ABLE TO TALK TO your Aunt Bessie in Florida and your sister Eileen in New York at the same time? You could ask the telephone operator who (for a special fee) could probably arrange such a round-robin conversation, commonly referred to as a conference call. Or, if you may be lucky enough to live in an area where the telephone company offers its subscribers a special conference-call service for an additional monthly fee.

If neither of these solutions appears practical, then just rummage through your junk box for a handful of parts, or buy everything you need from your nearest electronic parts dealer to make a conference-calling device for less than \$5. All you need is two 1- $\mu$ F nonpolar capacitors and a double-pole-single-throw (DPST) switch. If you want your project to look nice and make it simple to hook up, you can also buy a 3 X 2 X 1-inch plastic box and a telephone jack and plug.

One more important thing: To use this device, you must have two separate phone lines (i.e., two different phone numbers). Also, since this project is directly connected to the phone line, you should check with your local telephone company to see if it has any objection to your using this device.

### About the circuit

Talk about simple circuits . . . there aren't many simpler than this one. All the circuit consists of is two capacitors and a switch; even a novice electronics hobbyist should have no problem assembling this handy telephone accessory.

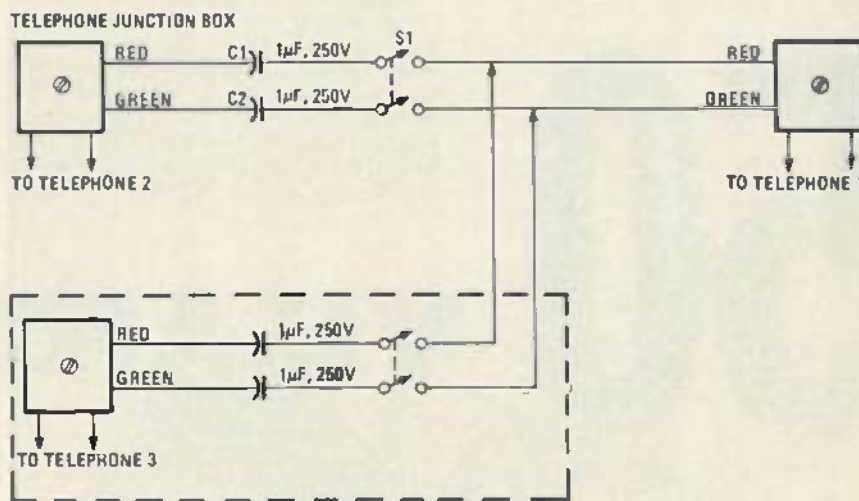
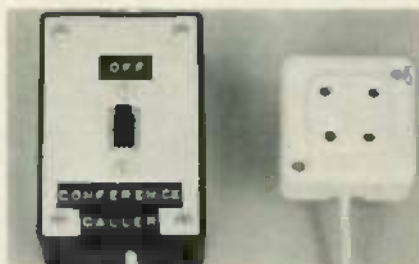

FIG. 1—WITH TWO SEPARATE TELEPHONE LINES brought to your desk or other convenient point, you can use this simple circuit to initiate conference calls.



THE CONFERENCE CALLER accessory and the jack-in-a-plug that makes it easy to connect to and disconnect from the phone lines.

### PARTS LIST

- C1—1- $\mu$ F 100 VDC, nonpolar capacitor
- C2—1- $\mu$ F 100 VDC, nonpolar capacitor
- SW—DPST switch

Basically, the circuit couples two telephone lines together without interfering with the operation of either line. It does this by letting the audio signals pass from one line to the other and preventing the DC control signal of the telephone network from passing through.

One way to accomplish this is to use a specially wound isolation transformer that has windings of equal impedance. A simpler and less costly method is to simply place a 1- $\mu$ F capacitor in series with the connections between the two telephones as shown in Fig. 1. The switch merely makes it possible for you to decide when to connect the second line in and when to cut it off.

*continued on page 71*

By HUGO GERNSBACK

*A half-century ago, the first radio for the public's use and enjoyment was marketed. Differing vastly from today's radios in construction and function, it opened the field of radio for private interest and amusement rather than commercial communications use.*

**T**HE year 1956 marked the 50th anniversary of the first home radio sold to the public anywhere in the world.

It was not radio as we know it today because in 1905 there was no commercial broadcasting. But wireless had been going strong for several years and amateur radio too had just begun. Marconi and other pioneers were transmitting intelligence by the dot-and-dash method; indeed wireless in those days was rapidly forging ahead.

The public at large knew little or nothing about wireless before 1905, except what they read in the papers and in magazines. As for owning a wireless home set, it had not as yet been born.

Previous to 1905, in 1903-04, the writer had been working on a small portable transmitter and receiving outfit which he felt could be sold to the public. It took several years to perfect it and make it foolproof so it would work under practically all conditions. It had to be low in cost so everyone could buy the outfit.

This ambition was realized some time in 1905. After making a number of models the writer began to market the first home or private radio set ever sold to the public.

As there were few wireless stations in the country, it became necessary to sell a transmitter, too, so amateurs could set up a transmitter and receiver at home. Then while one person was transmitting signals, the other could receive them. Or the transmitter could be set up in one room and the receiver would ring a bell in the other room

without any intervening wires whatsoever.

The outfit that accomplished all this was known as the TELIMCO Wireless Telegraph Outfit. TELIMCO is a contraction of the first letters of the writer's old pioneer firm, The Electro Importing Company (E. I. Co.), which became famous between 1904 and 1915 as the first radio mail-order house in the world. Only comparatively few sets were sold in 1905. But in 1906 the little outfit went into quantity production and was sold through many large outlets, including such famous stores as Macy's, Gimbel's and F. A. O. Schwarz, the country's largest toy establishment.

Incidentally, it was first advertised in the magazine *Scientific American* in the issue of Jan. 13, 1906. This was the first home radio set advertisement to appear in print anywhere.

The writer well remembers the incredulous looks of many of the store owners when they were first approached to buy "wireless sets." It was necessary to make a demonstration in each case before anyone would stock them.

The complete set, both receiver and transmitter, at first was marketed for \$7.50. This was raised later on to \$10, at which price most of them were sold.

The photograph shows an exact replica of the original outfit, built by the writer, to commemorate the 50th anniversary of the first home radio set. The transmitter, with the three dry cells and key, was composed of a 1-inch spark coil. The "1-inch" here means that the coil threw a 1-inch spark through free air, between wire points.

# 50 YEARS OF



Above—Advertisement for the first radio set offered the public. It appeared in *Scientific American*, Jan. 13, 1906. Right—Picture diagram of layout, drawn by Hugo Gernsback in the 1900's: A, G, antenna, ground; S, spark coil; B, batteries; K, key; AS, relay adjusting spring; SD, coherer—Connections: 9, 8, to relay electromagnets; 7, 11, coherer; 13, 16, decoherer; 14, 15, relay contacts.

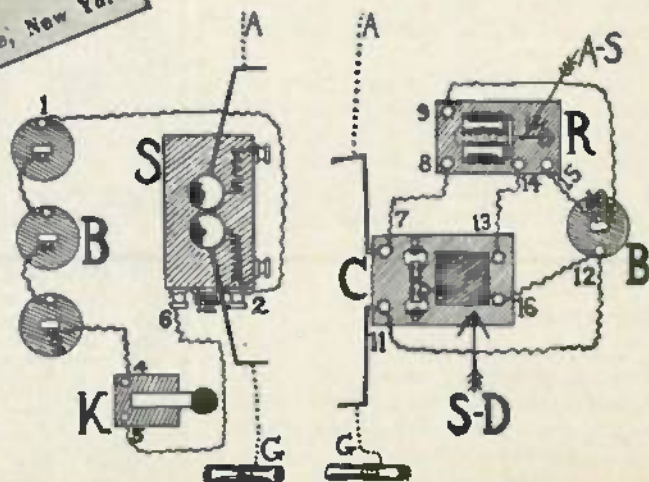

Mounted on the spark coil, on two metal standards, were two brass oscillator balls between which a small blue spark jumped the 1/4-inch gap. The spark coil had a fast vibrator so that every time you depressed the key a spark would jump between the two balls. Depressing the key for a short period would give a dot, a longer period would give a dash.

The receiver was a 75-ohm "pony" relay which had to be so sensitive that if you blew your breath slightly against the armature its contacts would close. There was also a single dry cell and the all-important *coherer*. It was simply constructed of two large, double binding posts through the bottom holes of which passed two silver-plated brass rods. A glass tube, placed between the two binding posts, was slipped over the two brass rods. These silver-plated 1/4-inch metal rods fitted the glass so that there was extremely little or no play. The two rods were separated about 3/16 inch, forming a gap. This gap was filled with the "soul of the set"—the coherer filings, composed of 90% coarse iron and 10% coarse silver filings. By shaking the mixture well it was ready to be used. The filings had always to be loose, *never packed tight*.

The decoherer—an ordinary house bell—was mounted so that the clapper of the bell would strike against the glass tube of the coherer at the exact spot where the filings were. If the diagram is studied, it will be seen that every time the relay closes its contacts, the bell will ring through the single cell.

Now, if you depress the key at the

transmitter, the two aeriels (aerial and counterpoise) will emit radio waves. Curiously enough, the waves which the writer used 50 years ago were of the very short variety (above 30 megacycles) to which modern radio has come back. The two aerial wires of the transmitter measured less than 1 1/2 feet.

Inasmuch as the coherer is directly in the receiver aerial circuit, the filings offer a very high resistance. But under the onslaught of the radio waves they instantly become an excellent conductor—as if they now were a solid conductor. The relay, in the same circuit, now goes into action, attracting the armature which closes its contacts. This sets off the decoherer bell which rings and shakes up the coherer filings. These now fly apart—they *decohere*—and the coherer becomes nonoperative until the next wavetrain comes along.

Thus every time you press the transmitter key, the bell at the receiver rings. It rings as long as you hold the key down. A long ring is a dash, a short one a dot.

You can pick up the receiver and walk to the next room, yet the bell sounds without any visible connection. Even through thick walls, signals still come in.

One of the things that bedeviled us in the early days was sparking at the relay contacts. This would set up electromagnetic waves and often the outfit gave no clear signals; sometimes the bell would ring for seconds *after* the signal. This was overcome by putting a 5- $\mu$ f capacitor across the relay points.

The range of the TELIMCO Wireless

Telegraph Outfit was between 300 to 500 feet when used without ground connections. By using an elevated aerial 50 to 100 feet in length and by grounding one side of both transmitter and receiver to a water or gas pipe, the range was easily increased to one mile. Indeed, hundreds of people who bought the outfit at the time reported excellent reception even over greater distances, but these, of course, were exceptions. Note that this set used *no tuning whatsoever*.

A curious thing about this little outfit today is its strange effect on radio people who never heard of the ancient spark coil and coherer sets. Young radiomen, who have never seen one of these outfits, are usually very much perturbed and astonished when the writer demonstrates it. The reason of course is that people have difficulty realizing that with a little three-dry-cell transmitter it is possible to ring a bell through intervening walls while the novice holding the receiver.

Radiomen today think of devices which operate relays as being relatively large and find it hard to believe that such a small portable transmitter and receiver could do the work.

It is conceivable that some time in the future these same instrumentalities may still find a use in modern radio and electronics which may not be apparent today.

The TELIMCO outfit here described has recently been acquired by the Henry Ford Museum of Dearborn, Mich. It was donated by the writer. It will be permanently exhibited in the radio section of the museum. END

# HOME RADIO

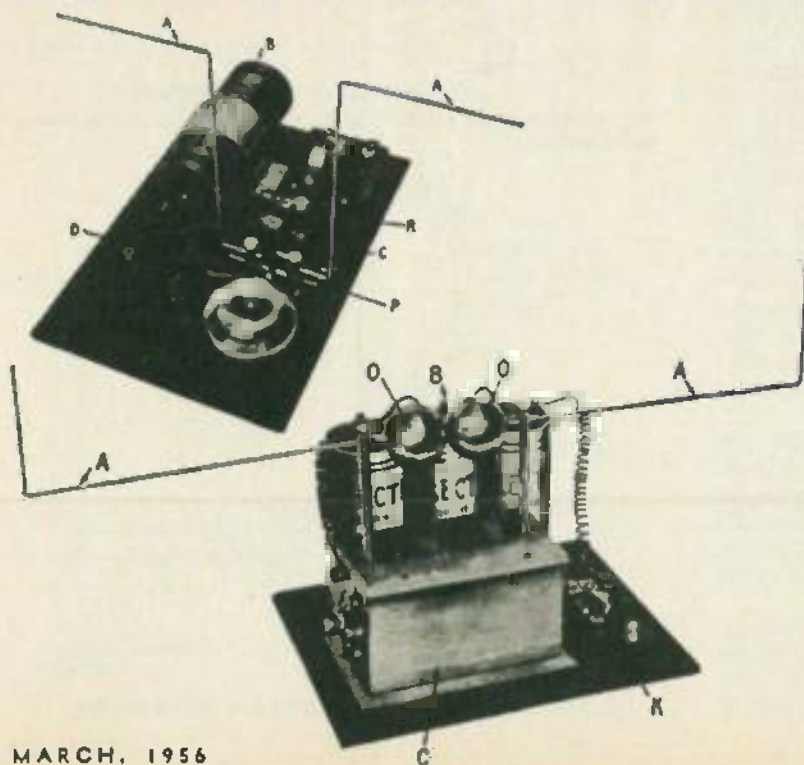

Replicas of the original transmitter and receiver, soon being sent to the Ford Museum at Dearborn. Left—the receiver: A, antenna system; B, dry cell; C, coherer; D, decoherer; P, adjustable coherer rods; R, 75-ohm relay. Right—the transmitter: A, antenna and counterpoise; B, dry-cell power supply; C, 1-inch spark coil; O, spark-ball oscillators; K, transmitter key.

# BUILD THIS



# TRS-80 BREADBOARD

*Part 3—Build this breadboarding device that serves as an interface between the TRS-80 microcomputer and circuits you are designing. Here are some experiments that show how the device can be used.*

JON TITUS, CHRIS TITUS, and DAVID LARSEN

IN THE LAST TWO ISSUES WE COVERED THE DEVELOPMENT AND construction of this interfacing breadboard that lets you connect external devices to your TRS-80. Now, let's see how to use it.

### Experiments you can do

**A simple traffic light controller:** In this experiment, you will construct a traffic light simulator so that various light patterns may be experimented with, under the control of programs in the TRS-80 computer. The first step is to construct the "traffic light" using individual colored LED's, and the second step is to develop the necessary software that can be used to control the needed lamp patterns. Wire the output port shown in Fig. 16. Make the necessary connections between the two SN7475 latches and the data bus. Remember that each of the latch IC's requires a power and ground connection for proper operation. Individual LED's have been used to simulate the traffic light's lamps. You will find that colored LED's make the patterns easy to recognize. Individual 220-ohm current-limiting resistors have been used with each LED. The SN7475 latch outputs have been used to directly drive each LED. In this configuration, a logic zero at a latch output will turn the corresponding LED on, while a logic one will turn the LED off. The latch enable input may be obtained from the NOR gate circuit shown in Fig. 15.

If this circuit is not wired on your solderless breadboard, you may wish to wire it at this time. Remember to connect +5 volts and ground to the SN7402 NOR gate. In this configuration, the latches will only be activated to accept information from the TRS-80 when an OUT 6.X instruction is executed. Of course, X must be defined in the program so that the computer knows what is to be output to the latches.

Once the LED's have been wired to the latch IC's, and the latch IC's have been interfaced to the TRS-80 through the interface breadboard, you should try and test each of the LED's. First, to be sure that all of the LED's have been turned off,

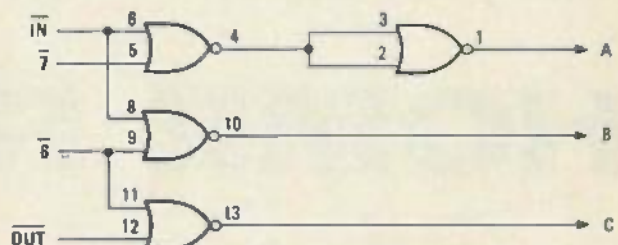

THE FOUR NOR GATES ARE FROM SN7402

FIG. 15—SCHEMATIC DIAGRAM of the NOR gate circuit used for testing the breadboard.

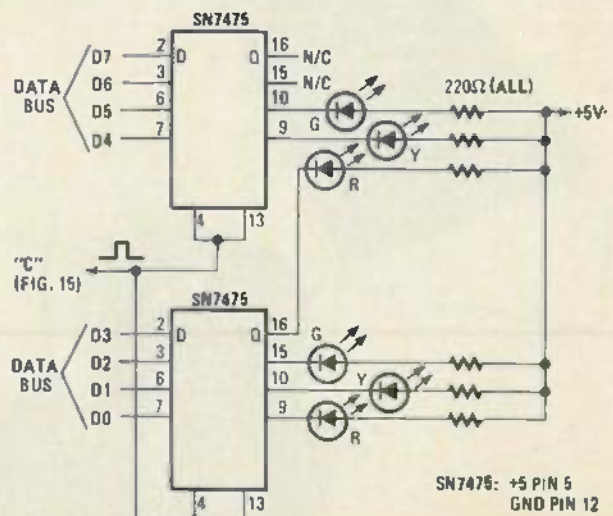

SN7475: +5 PIN 5  
GND PIN 12

FIG. 16—A SIMPLE traffic-light simulator. See text for program.



execute an OUT 6.255 command. Now, with the following LED configuration:

Bit	LED	
D0	Red	
D1	Yellow	ELM Street
D2	Green	
D3	Red	
D4	Yellow	MAIN Street
D5	Green	

determine what patterns of logic ones and logic zeros are needed to control each of the individual LED's.

Since the latches can drive the LED's directly, the following bit patterns were assigned to each of the LED positions:

ELM	Red	254 <sub>10</sub>	1111110 <sub>2</sub>
ELM	Yellow	253	11111101
ELM	Green	251	11111011
MAIN	Red	247 <sub>10</sub>	1110111 <sub>2</sub>
MAIN	Yellow	239	1101111
MAIN	Green	223	11011111

Once you have compared these individual patterns with the ones you have determined, test them using your computer and your interface. You should be able to use statements such as OUT 6.251 to test each LED.

When all of the LED's have been tested, write a short program that will flash the yellow lamp on Main Street, while flashing the red lamp on Elm Street. Both of the lamps may flash at the same time, or they may alternate. Use a 2-second flash period; that is, 2 seconds on, 2 seconds off, and so on. The following program may be used to flash the lights at the same time:

```

10 OUT 6.255
20 FOR T=0 TO 300:NEXT T
30 OUT 6.238
40 FOR T=0 TO 300:NEXT T
50 GOTO 10

```

Two time-delay statements have been used, one at line 20, and the other at line 40, to create one second delays in the program. Since two of the LED's are to be turned on and off at the same time, the bit pattern is 11101110, or 238. We will leave it up to you to write the program that could alternate the flashing LED's, rather than flashing them at the same time.

To actually simulate a traffic light, you must first figure out what lamp patterns are required at an intersection. We suggest that you try and do this before you go on. You can then compare your answers with ours. Actually, only four different patterns are required, which may seem to be fewer than you expected. These patterns are noted below:

1. Red on Elm, Green on Main	222
2. Red on Elm, Yellow on Main	238
3. Green on Elm, Red on Main	243
4. Yellow on Elm, Red on Main	245

The decimal equivalent for each pattern has also been determined.

Now, the program to control the traffic light must be developed. You should assume a 2-second yellow period, with a 6-second green period for Elm Street, and a 10-second green period on Main Street. Once the lamp patterns have been determined, the program is rather simple. The following program may be used:

```

10 M=10:E=6
20 DATA 222, 238, 243, 245

```

```

30 READ L
40 OUT 6.L
50 FOR I=0 TO M
60 FOR T=0 TO 300:NEXT T
70 NEXT I
80 READ L
90 OUT 6.L
100 GOSUB 1000
110 READ L
120 OUT 6.L
130 FOR I=0 TO E
140 FOR T=0 TO 300:NEXT T
150 NEXT I
160 READ L
170 OUT 6.L
180 GOSUB 1000
190 RESTORE
200 GOTO 30

```

```

1000 FOR I=0 TO 2
1010 FOR T=0 TO 300:NEXT T
1020 NEXT I
1030 RETURN

```

While this program worked quite well, there are a number of simplifications that can be made to make the program more compact and more efficient. Can you suggest some changes that could be made?

In the second traffic light controller program, an array has been set up for the traffic light lamp patterns, and also for the periods for which they are to be activated. Now, a generalized control program can be used, rather than the long sequencing program used previously. Some statements have also been added so that you may enter the periods needed for Elm and Main green times (in seconds).

```

10 A(1)=222:A(2)=238:A(3)=243:A(4)=245
20 M(1)=0:M(2)=2:M(3)=0:M(4)=2
30 INPUT "MAIN";M(1)
40 INPUT "ELM";M(3)
50 FOR Q=1 TO 4
60 OUT 6.A(Q)
70 FOR I=0 TO M(Q)
80 FOR T=0 TO 300:NEXT T
90 NEXT I
100 NEXT Q
110 GOTO 50

```

So far, the computer has been used merely as a sequencer, since it has only performed simple sequencing functions, with fixed times between each lamp pattern. There are probably many situations in which this type of sequencing might be useful. Just think of the many tasks that you perform time after time, with little or no variation. Let's now consider expanding the traffic light program so that it will respond to changing traffic patterns. We will assume that two sensors on Elm street (one for cars going in either direction), and two sensors on Main Street have been OR'ed together so that cars are readily detected by the computer. Assume that the E and M keys on the computer are used for the car sensing functions.

Develop a program that will normally have the traffic light in the Elm Street—Red and Main Street—Green situation. After thirty seconds of "green on Main Street" have elapsed, the computer will start to sense cars on Elm Street. If cars are sensed after this initial 30-second period, then Elm Street will

## KIT INFORMATION

The following parts are available from E & L Instruments, Inc., 61 First St., Derby, CT 06418.

Order No. 355-6125—Complete kit including PC board, case and all parts. Does not include interconnect cable. Specify 117V or 230V version. \$139.00.

Order No. 355-6175—Interconnect cable assembly (connects breadboard to

TRS-80 computer). \$25.00.

Order No. 355-6100—Assembled 117-volt version. \$185.00.

Order No. 355-6150—Assembled 230-volt version. \$185.00.

Connecticut residents add state and local taxes as applicable.

A pre-drilled and etched PC board is available from Techniques, Inc., 235 Jack-

son St., Englewood, NJ 07631, for \$24.50 postpaid. New Jersey residents add 5% sales tax.

Copies of the book *TRS-80 Interfacing* (published by Howard W. Sams and Co.) is available for \$7.95 plus 79¢ for shipping and handling from Group Technology, Ltd., PO Box 87, Check, VA 24072

be cycles through a 30-second (or less) green period. Since it will irritate drivers on Main Street when a single car actuates the Elm Street green period for 30 seconds, the program must also count the cars sensed on Main Street, when the Elm Street green period has started. When a certain number of cars, say five, are sensed on Main Street, then a new green period on Main Street will be started. Of course, each "switch" in the light patterns must go through the normal green-yellow-red sequence. Try and develop this program to control the traffic light. With some variations in timing, we used the program that follows. Shortened time periods were used to speed the testing of the program:

```

10 A=0
15 REM RED ON ELM, GREEN ON MAIN
20 OUT 6.222
30 FOR I=0 TO 10
40 FOR T=0 TO 300:NEXT T
50 NEXT I
60 A$=INKEY$
65 REM E KEY PRESSED AFTER 10 SECONDS
70 IF A$="E" THEN 80 ELSE 60
75 REM RED ON ELM, YELLOW ON MAIN
80 OUT 6.238
90 FOR I=0 TO 2
100 FOR T=0 TO 300:NEXT T
110 NEXT I
115 REM GREEN ON ELM, RED ON MAIN
120 OUT 6.243
130 FOR I=0 TO 10
140 FOR T=0 TO 150
150 B$=INKEY$
160 IF B$="M" THEN 190
170 NEXT T:NEXT I
180 GOTO 210
190 A=A+1
200 IF A=5 THEN 210 ELSE 170
205 REM YELLOW ON ELM, RED ON MAIN
210 OUT 6.245
220 FOR I=0 TO 2
230 FOR T=0 TO 300:NEXT T
240 NEXT I
250 GOTO 10

```

#### Controlling an analog voltage:

There are many situations in which a variable analog voltage is required. Controlling such a voltage by using the TRS-80 computer and some simple software provides a great deal of flexibility that can not be obtained in other ways. Probably the easiest way to have a small computer generate an analog voltage is through the use of a digital-to-analog converter (D/A). These devices are available in many configurations, but they can be briefly explained by stating that they can produce a voltage within a known range, say zero to +10 volts.

The actual voltage produced is proportional to the binary value provided to the converter by the computer. Thus, for an eight-bit D/A converter, a binary value of zero would cause the converter to output zero volts, while an input of 255 (11111111) would cause the converter to generate the full 10-volt output. A binary value between these limits would cause the converter to generate a proportional voltage, for example, 10000000, or 128, would generate a +5-volt output. For additional information on D/A converters and other interesting converter devices, we refer you to: *Microcomputer-Analog Converter Software & Hardware Interfacing*, Howard W. Sams and Co., Inc., 1978.

In this experiment, a Signetics NE5018 eight-bit D/A converter IC has been used. Other similar eight-bit converters may also be used, providing similar results, but the NE5018 has some nice features that make it easy to use in computer systems. These features include a built-in eight-bit output port latch, an on-chip reference and an on-chip buffer amplifier. The NE5018 is wired as shown in Fig. 17. An SN7402 NOR gate chip has also been used to generate the required Latch Enable (LE) signal that will control the flow of eight bits of information to the latch, and thus to the D/A converter.

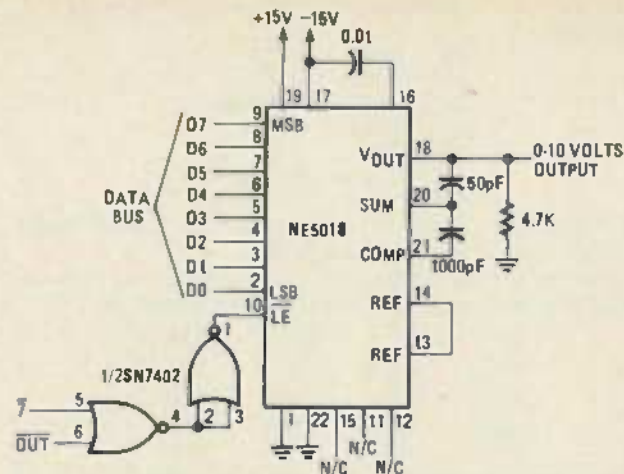

FIG. 17—A SIMPLE 9-BIT digital-to-analog interface.

Actually, the D/A converter does not generate a continuously varying voltage, since only 256 different voltages may be produced, one per eight-bit value. This means that in a converter with a zero to 10-volt range, the individual voltages will be approximately 39 millivolts from the one on either "side" of it. With the interface shown in Fig. 17 connected to your interface breadboard, try and write short programs that will 1) generate a positive-going voltage ramp over and over again, 2) do the same thing for a negative-going voltage ramp, and 3) generate a slowly increasing and then slowly decreasing voltage outputs to generate a triangular output. These programs are listed below:

#### 1) Program for a Positive Ramp

```

10 FOR I=0 TO 255
20 OUT 6,I
30 NEXT I
40 GOTO 10

```

#### 2) Program for a Negative Ramp

```

10 FOR I=255 TO 0 STEP -1
20 OUT 6,I
30 NEXT I
40 GOTO 10

```

#### 3) Program for a Triangular Voltage Output

```

10 FOR I=0 TO 255
20 OUT 6,I
30 NEXT I
40 FOR I=254 TO 1 STEP -1
50 OUT 6,I
60 NEXT I
70 GOTO 10

```

There are many applications in which D/A converters are useful, and in fact, some computer systems have a number of D/A converters interfaced to them. Some possible applications include the control of X-Y plotters so that graphic displays of information may be produced, the control of servo motors for positioning solar detectors/collectors, the sweeping of frequency generators to generate computer music, the control of filters to filter out various types of electrical noise, and even the generation of known voltages that may be compared against unknown voltages to determine their value.

There are many, many other digital devices that may be interfaced to your TRS-80 computer through the interface breadboard: UART's and USART's for serial communications, 20 mA RS-232C loops for teletypewriter and terminal control, advanced programmable controller chips, analog-to-digital converter chips for measurements, and even other microcomputers. In fact, we have interfaced our TRS-80 computer to an MMD-1 computer (Dyna-Micro, Radio-Electronics, May, June & July 1976), so that programs may be listed on a teletypewriter.

R-E

## Home Reception Using Backyard Satellite TV Receivers

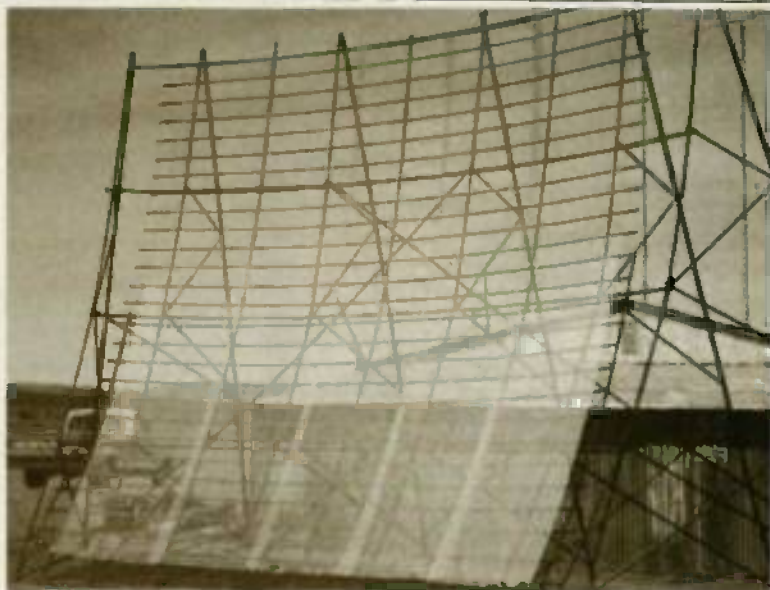

SWAN SPHERICAL ANTENNA is effective in receiving satellite transmissions and can be built relatively inexpensively.

*Part 4—In this installment of a series, we will go into more technical details on receiver characteristics and specifications and will show how some satellite receivers have been built at comparatively low cost.*

ROBERT B. COOPER, JR.

IN PARTS ONE, TWO, AND THREE OF THIS multiple-part series (appearing in the August, September, and October 1979, issues of *Radio-Electronics*) we learned how the geo-stationary satellite system is designed, what it is intended to do and what a private individual, living someplace south of the 80th north parallel, north of Venezuela, and east-west between Bermuda and Hawaii can anticipate being able to receive with a private, backyard satellite television terminal. Satellite television is the next "generation" of television service in America and throughout wide areas of the world. Because of the mechanics of the service, it is virtually immune to interference and signal degradation, is not adversely affected by weather, and holds the potential to provide every home in North America with several hundred direct-access television channels!

### Receiving system

Having determined that the basic system consists of an antenna, a low-noise amplifier (LNA) and a receiver-demodulator, let's look at what it is that goes into each of these three major component modules to make up the operating system.

The antenna system has been adequately covered in previous portions of this series. Basically, in order to achieve

the kind of gain necessary (38 to 45 dBi) a parabolic reflector is the best antenna choice. This parabolic reflector has a single focal point where all of the energy intercepted by the reflective antenna surface is re-directed and focused. There are several acceptable members of the antenna family known as parabolics that can be pressed into this service: prime focus parabolics, Cassegrain parabolics and spherical parabolics are included. For as long as the (limited) supply holds out, surplus (as in no longer used in commercial or military service) parabolic (or "dish") antennas larger than 8 feet in diameter provide very economical "reflector surfaces" for most portions of North America. The exception to this is in New England where anything smaller than a twelve-foot reflector surface would be a mistake. Beyond that, one of the least expensive antenna surfaces for this service has been developed by a fellow in Arizona named Oliver Swan. Using aluminum window screening as a reflector surface, and stock square aluminum or steel tubing as reflector frame material, Swan has developed a spherical antenna system that can be constructed in virtually any size from 10 feet by 10 feet to 20 feet by 20 feet for as low as approximately \$500 for the ten-foot by ten-foot version. It is inevitable that some commercial firm will soon begin marketing antenna "kits" in this

area, perhaps copying the Swan developed spherical antenna and that from this will spring a whole new family of "backyard decorative pieces."

Because we are dealing with a low-power transmitter source (the typical satellite has a 5-watt peak power transmitter) and a fairly high loss between the "bird" and your receiving location (196 to 200 dB is typical at 4 GHz), not very much signal power arrives at your antenna. Fortunately, the signal received is very constant (variations of  $\pm 0.7$  dB over a full year are typical limits) and this allows us to design the system for peak performance and forget it rather than be concerned with wide-range AGC systems to cope with large signal fluctuations.

To make the most of the weak signal, we have to place a very high gain, and extremely low noise (figure) signal amplifier (or booster in TV terms) right at the antenna. Since the reflector surface on the parabolic is merely a focusing tool, the actual "pickup antenna" is really separate and distinct from the reflector. This receiving antenna, directed backwards away from the satellite and towards the focused energy coming from the reflector surface, is called a "focal point" or feed-point antenna.

The most efficient feed antenna is one that looks at the reflector surface in such a way that the "pattern" on the feed antenna is down 10 dB at the out-

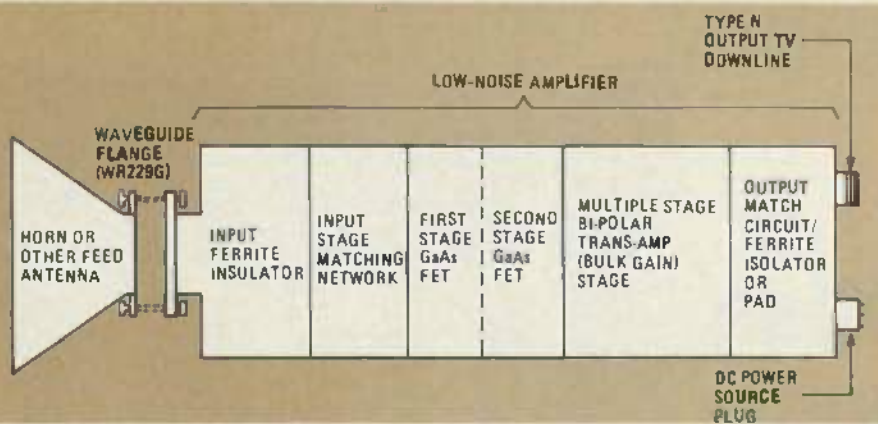

FIG. 1—MOST COMMERCIAL FEED-ANTENNA LOW NOISE AMPLIFIERS consist of a feed antenna (often a horn as shown for a prime-focus feed) which is equipped with a waveguide flange that bolts it directly to the input flange on the LNA (Low Noise Amplifier). The LNA has an input (ferrite) isolator both for frequency selectivity and as an impedance matching device for the first stage of the amplifier itself. The extremely low-noise amplifiers develop their superior operating characteristics because of extreme care taken in matching the first stage to the input source impedance and by carefully hand selecting the expensive GaAs-FET (Gallium Arsenide Field Effect) transistors. GaAs-FET devices are chosen for the first two stages. Once the noise figure is "established" by these two stages, less costly bipolar transistors are used in 3-4 additional stages for "bulk" gain. The output, to the low-loss downline coaxial cable, is through another ferrite isolator device or through a "loss pad" inserted to force an impedance match.

side edges of the reflector's surface area. A horn-feed antenna, properly designed, handles this function. Look closely at Fig. 1. Note that the horn-feed antenna is flanged or bolted directly to the low-noise amplifier itself; the energy from the horn feed-point antenna couples through the waveguide flange into the input circuit on the low-noise amplifier, a section that has a piece of ferrite (rod) in it as an isolator.

### Low-noise amplifiers

This commercial style low-noise amplifier is the state-of-the-art high-dollar approach to the low-noise amplification aspect of the system. There are less expensive ways to go as we shall see in subsequent portions of this series. The purpose of the ferrite isolator is primarily to insure that the input circuit to the first active (transistor) amplifier stage sees a constant impedance or load. This is done to insure that the transistor used in the first stage, a GaAs-FET (for Gallium Arsenide Field-Effect Transistor), is noise-figure matched at the 4 GHz operating frequency. Most of the high-dollar GaAs-FET's available for this service have two separate peak operating points; maximum gain does not coincide with best (i.e. lowest) noise-figure performance. In this case, gain is backed off in the first couple of stages as a trade off for lowest noise figure since noise generated in the early pre-amplifier stages is impossible to eliminate later on in the system.

Most of the commercial LNA units employ a pair of ultra-low-noise GaAs-FET's in the first two stages, and then follow that up with between three and five less expensive (typically bipolar as opposed to GaAs-FET) amplifier stages. Once the noise figure for the LNA is es-

tablished by the first couple of stages, less expensive (and higher noise figure) bipolar stages can make up the remainder of the LNA system gain required.

Noise figure is measured in both dB and by the Kelvin noise temperature scale. Most of the commercial data sheets will specify Kelvin temperature only and most commercial installations are using amplifiers with 120-degree Kelvin (or 1.5 dB noise figure) specs.

State-of-the-art has been catching on quickly in this field; in late 1976 the price for a 120-degree Kelvin LNA was in the \$3,500 region. By late 1978 you could find the same amplifier for around \$1,800. Today the price is down in the \$1,000 region and many expect it to drop down close to \$500 by this time next year. That still may be high for your pocketbook and there are other options.

As previously discussed in this series, you can get a raw signal input to the receiver by one of two techniques; use a big antenna and an LNA with not such hot specs, or, use a smaller antenna and a hot-spec LNA. If you set out to build your own antenna system, rather than buying commercially, you might be better off in this fast-changing technology time to invest in a little more steel and mesh and build a larger antenna going in, especially if you plan on having to purchase your LNA.

As recently as early in the past summer anyone who wanted to build his own LNA was pretty much stuck with working with 300-degree Kelvin type bipolar transistors. The belief was that any home constructor attempting to work with the touchy, and hard-to-make-work GaAs-FET amplifiers was probably asking for a quick way to lose a \$100 bill; that being the going price for the GaAs-FET transistors these days

from Hewlett-Packard (HFET 2201). However, during the recently completed Satellite Private Terminal Seminar this past August 14-16 in Oklahoma City, several home terminal builders demonstrated two- and three-stage GaAs-FET amplifiers they had constructed for between \$225 and \$350 that gave an excellent account of themselves against commercial amplifiers costing three to four times as much. This major achievement has changed the name of the private or backyard terminal game for the home constructor.

Well now: if a chap in Arizona can build a 10-foot by 10-foot spherical reflector and feed for \$500 or less, and you can build your own GaAs-FET low-noise amplifier on the kitchen table for \$350 or less, that starts to get the home-constructed terminal down to an affordable price does it not? What about the receiver?

### Receivers

In 1976 the first satellite video receivers around came into the cable television field via the Intelsat or international satellite marketplace. They cost upwards of \$10,000 and were literally hand wired and hand aligned.

By early 1978 the price for essentially the same receiver was down to about half that; perhaps \$5,000. But there had been only minor changes in the original design. The price reductions were largely due to slightly more volume production, and of course competition.

Needless to say many people were working on bringing the cost down; way down. Most however were involved in the cable TV, broadcast TV and other commercial market areas where nobody really expected receiver prices to drop much below say \$3,000 for many years to come. Outside of these broadcast related industries other engineers with a totally different set of markets in mind were quietly doing their own developmental work. Their goal was a \$3,000 complete terminal; including the antenna and the LNA.

By mid-1979 some inter-receiver marrying had taken place. Commercial receivers are available in two formats; some tune only one channel and to change channels you have to either change crystals or go through some sequence of screwdriver adjustments, or both. Not exactly what the home viewer accustomed to detent tuning has in mind. The other commercial receiver format is called "frequency agile" and that means you push buttons or twirl a knob and the full set of 12 (or 24) satellite channels flips by in front of you. By mid-1979 some of the commercial receivers in the single channel format were down under \$2500 list price while the tuneable versions were just a tad above \$3,000.

Let's stop for a minute and study Fig. 2. To appreciate what is involved in a satellite television receiver, we ought to understand what it has to do.

In a commercial installation the LNA (which mounts at the antenna, usually married to the feed-horn or focal-point antenna) has to develop sufficient RF signal voltage gain, at 4 GHz, to (1) drive the microwave signal through the interconnecting coaxial cable and into the receiver, and, (2) provide sufficient signal gain to establish the noise figure of the LNA as the noise figure for the whole receiving system.

The typical satellite TV receiver has a relatively high noise figure: 10-12 dB is not uncommon. To attempt to use such a high "front-end" noise figure to receive the weak satellite signals would be a mistake. To lower the noise figure to a more usable level (such as under 2 dB) requires not only a low-noise LNA but sufficient gain in the LNA stages to override the noise contribution by the 10-12 dB noise figure of the receiver. As a rough rule of thumb you need between 2.5 and 3 times as much voltage gain (in dB) as the noise figure (also in dB) to establish the new, lower noise figure of the LNA as the noise figure of the system as a whole.

Back now to Fig. 2. To keep unwanted energy out of the receiver (and there is plenty of unwanted or off-frequency energy floating around microwaves these days) the typical commercial receiver has a pre-selector (either totally passive or active plus passive) at the input. This is followed by a "high frequency-mixer" that combines the incoming (3.7 to 4.2 GHz) signals with a local oscillator signal source generated within the receiver to produce a new lower frequency (IF) output. Gain is

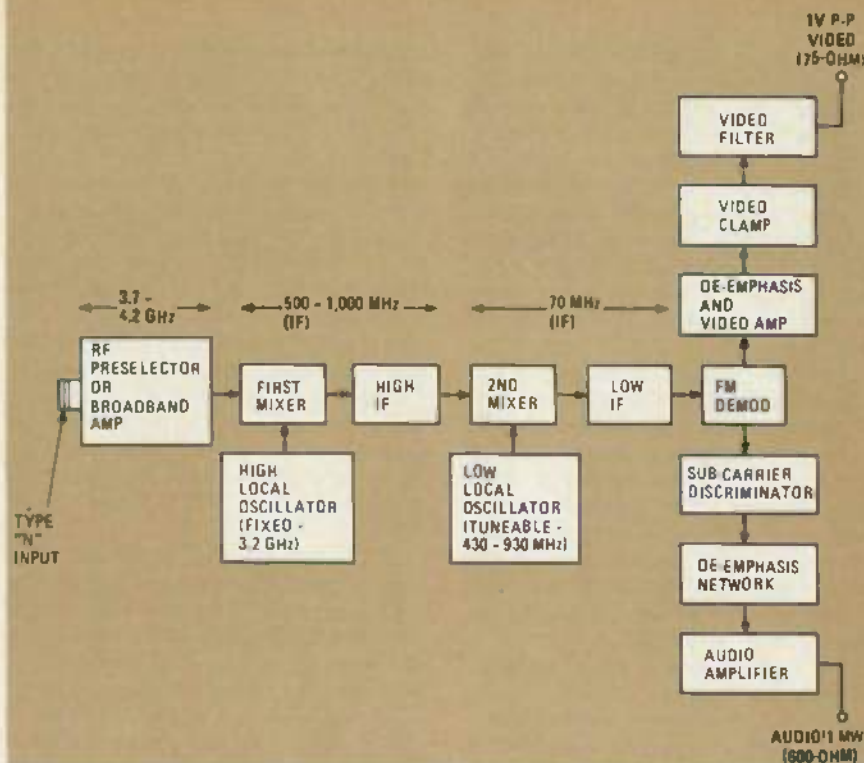

FIG. 2—MOST COMMERCIAL RECEIVERS use high-gain (50 dB) LNA's mounted at the antenna capable of driving 4-GHz region signals through several hundred feet of 7/8ths inch line to the indoor receiver. Typical receiver has either double conversion (approach shown here) or single conversion directly to IF. In receiver design shown, a 3.7- to 4.2-GHz preselector often has enough gain to bring the input RF level up to an adequate voltage to drive the first mixer. Relatively high-level high-frequency local oscillator (3.2 GHz is shown in example) may measure +10 dBm or more. With local oscillator on low side, high IF of 500-1,000 MHz is attained to drive second mixer that down converts to 70-MHz low IF. Oscillator for second local oscillator is voltage- or capacitive-tuned to produce 70-MHz low IF with inputs over full 500-1,000 MHz range. FM demodulator (discriminator) produces basic baseband signal that processes up for video to a de-emphasis circuit and video amp, then to a video clamp to eliminate the 30-Hz energy dispersal waveform, and then to a filter circuit. Audio processes down through separate (6.8 MHz) discriminator, de-emphasis network and audio amplifier.

then applied at the high-frequency IF and then the signal goes through yet a second mixer that further down-converts the high IF to yet a lower IF. This lower IF is often 70 MHz although there are some variations to this rule in

commercial receivers. When we finally reach the lower IF, we have gone through a pair of down conversions each employing a high-quality mixer and a high-quality local oscillator. If this is a frequency-agile (i.e. tuneable) receiver the first mixer is driven by a tuneable local oscillator source while the second mixer is driven by a fixed local oscillator source. Just for dollar reference, we are looking at using \$75 to \$100 mixers in these applications and the local oscillators are priced in about the same range. If this suggests that microwave components or modules are not cheap, you read the message correctly.

Once at the low IF we are ready to go to work on the modulation itself. Gain at a relatively low IF such as 70 MHz is inexpensive these days and 40-50 dB of gain in this range is typical. When the twice-down-converted signal is built up to a sufficient voltage level, it is ready to be demodulated. Remember that the video is frequency modulated onto the carrier, and the audio coming along with the video is further frequency modulated as a sub-carrier. This says that we use discriminators to demodulate the video and the audio in our detection system.

By removing the video signal out of the IF signal with a detector, we end up



HORN ANTENNA/LNA combination points directly towards the dish antenna. Coaxial cable is used to connect the LNA to the receiver.

with what is called baseband; that means pure video in this case. Only because the audio is carried along as a 6.2- or 6.8-MHz add-on or subcarrier, when we demodulate to baseband video we also have a aural subcarrier in the baseband output. By using a low-pass filter for the video and a high-pass filter for the aural subcarrier, we can then separate the video into one chain for further processing and the audio into another.

The video is preemphasized at the uplink transmitter site as a means of increasing the system performance and at the receiver we need to deemphasize to establish the original baseband video characteristics. The deemphasis network is strictly an L-C network and is not complicated. Next in line for the video is a video clamp circuit that may mystify you if you are accustomed to normal video techniques.

Video at the uplink site is "frequency-dithered" or dispersed at a 30-Hz rate as a means of reducing potential interference between strictly terrestrial 4 GHz video circuits (such as the telephone companies employ) and the satellite service. The easiest way to clean up

the dispersal waveform is to shove the video through a clamping circuit. If you clamp something like this *hard* enough, the 30-Hz waveform simply goes away. Finally a bit of passive video filtering and you are in business with baseband video (typically 1 volt peak-to-peak).

Over on the audio side, after passing the 6.2 or 6.8 MHz aural subcarrier through a frequency filter that eliminates the video baseband information, the signal is fed into yet another discriminator (detector) that recovers the audio. From here it goes through yet another deemphasis network (this one for the audio) and finally an audio amplifier. Most commercial receivers release the audio across a 600-ohm balanced output line.

If you are engaged in the television receiver servicing industry, you may be asking yourself why this should cost between \$2500 and \$3500 a pop. If you are new to receivers in general, you probably have the opposite reaction.

As we shall see in the next part of this series of articles, several experimental or private terminal builders have asked themselves the same thing. One terminal builder, Taylor Howard

of California, has managed to assemble the LNA (a bipolar unit in his case) and the receiver for around \$1,000. He did this back in 1976-77 when parts were considerably more expensive and we estimate you can do it today for under \$700.

Assuming you don't want (or need) to start off with a bag full of new parts, and can assemble some equipment from other services into a satellite TV receiver, just how simple can it really be? Well, a man in South Carolina by the name of Robert Coleman has put together a 10-foot dish, a two-stage GaAs-GET LNA and a complete receiver for around \$500! His "secret," if you can call it that, is that he is a sharp attendee of Hamfests and other outlets where surplus electronic equipment is brought out for sale at often just a few pennies on the original dollar value. The Coleman approach is a good one, but it requires being able to trace down surplus parts, modules and components that may not be a good supply because of limited production runs many years (or decades) ago. Still, if this approach does interest you and you are not afraid to go into the surplus market to look for parts, there is help available for you in this specialized area.

Suppose you wanted to try a cross between building a complete terminal receiver from scratch and assembling one from surplus equipment? Well, that is an approach many people have followed, largely patterned after the work done by English satellite TV experimenter/pioneer Steve Birkill (amateur G8AKQ). The Birkill receiver is similar to that shown in Fig. 3. The LNA is a bipolar system of three to five stages using Hewlett-Packard HXTR (6102 and 6101) transistors. For those who want to investigate this particular approach, Hewlett-Packard Application Note No. 967 tells how to build a stage of this amplifier at 4 GHz (a multiple stage-device is simply several separate stages cascaded together).

The Birkill Receiver places the LNA stages at the feed antenna, follows that with a double-balanced mixer (also located at or near the feed) and the mixer is driven by both the input 4 GHz range signal(s) plus a "free-running" oscillator operating at around 3,200 MHz. There are several ways to derive the local oscillator injection signal; one of the easiest is to use a completely self-contained oscillator. One of the 8360-family of oscillators manufactured by Avantek, Inc., 3175 Bowers Ave., Santa Clara, CA 95051 will do the job nicely. This TO-8 packaged device has four pins on it: one for the positive operating voltage, another for a ground, a third for the RF output in the gigahertz region and a fourth for a tuning voltage that allows you to run the oscillator through a 500-MHz span. Most homebrew (from

#### LEARNING MORE ABOUT SATELLITE TV

Readers with an interest in pursuing further the details of the Home Satellite TV Reception system may be interested in the following reference materials available:

**Satellite Study Package**—includes a 72-page "Handbook" describing the complete home satellite TV receiving system, how the satellites operate, where to locate equipment and what services are available via satellite, written by Bob Cooper. Also includes 22-by-35 inch four-color two-sided wall chart depicting each of the geostationary TV satellites in operation and explaining the technical equations of the satellite TV system. Satellite Study Package is excellent "starter set" towards a full understanding of the system and getting your own system underway. Price is \$15 via first class mail (U.S. and Canada in U.S. funds) or \$20 elsewhere from Satellite Television Technology, P.O. Box 2476, Napa, CA 94558.

**Home Satellite Construction Manuals**—three separate manuals available describing construction details (parts lists, sources for parts, schematics where applicable) of two separate receiver systems, low-cost low noise amplifiers and the unique new Swan Spherical TVRO antenna. The Coleman TD-2 Manual describes conversion of surplus microwave equipment to TVRO terminal plus showing latest low-cost methods of amplifying and converting 4-GHz signals to 70-MHz IF; the original Coleman system cost under \$500 to build. The Howard

Terminal Manual describes a 24-channel frequency-agile (tuneable) receiver plus bipolar LNA using off-the-shelf new parts that can be duplicated for under \$800. Taylor Howard, a professor at Stanford, has had this system operational since 1976. The Swan Spherical TVRO Antenna Manual describes construction of a unique multi-satellite reflector surface plus a unique lead-horn; Inventor Oliver Swan shows how a 10- to 12 foot-size antenna can be assembled with common hardware for under \$300. Price of each manual is \$30 or all three for \$80 from: Satellite Television Technology, P.O. Box G, Arcadia, OK 73007.

**Satellite Private Terminal Seminar**—this past August more than 500 satellite TV enthusiasts attended first-ever "international seminar" as more than a dozen instructors (including Taylor Howard, Robert Coleman, Oliver Swan, and Paul Shuch) taught in classroom sessions the latest in low-cost satellite TV circuit technology. SPTS '80 will be held in Miami, Florida on February 5, 6 and 7 with special emphasis on how to market and install private low-cost terminals throughout North, Central and South America. There will be exhibits, live-satellite systems demonstrations, and course study books. Registration is \$150 per person; advance registration required. For full information write: SPTS '80/Miami, P.O. Box G, Arcadia, OK 73007 or call (405) 396-2574.

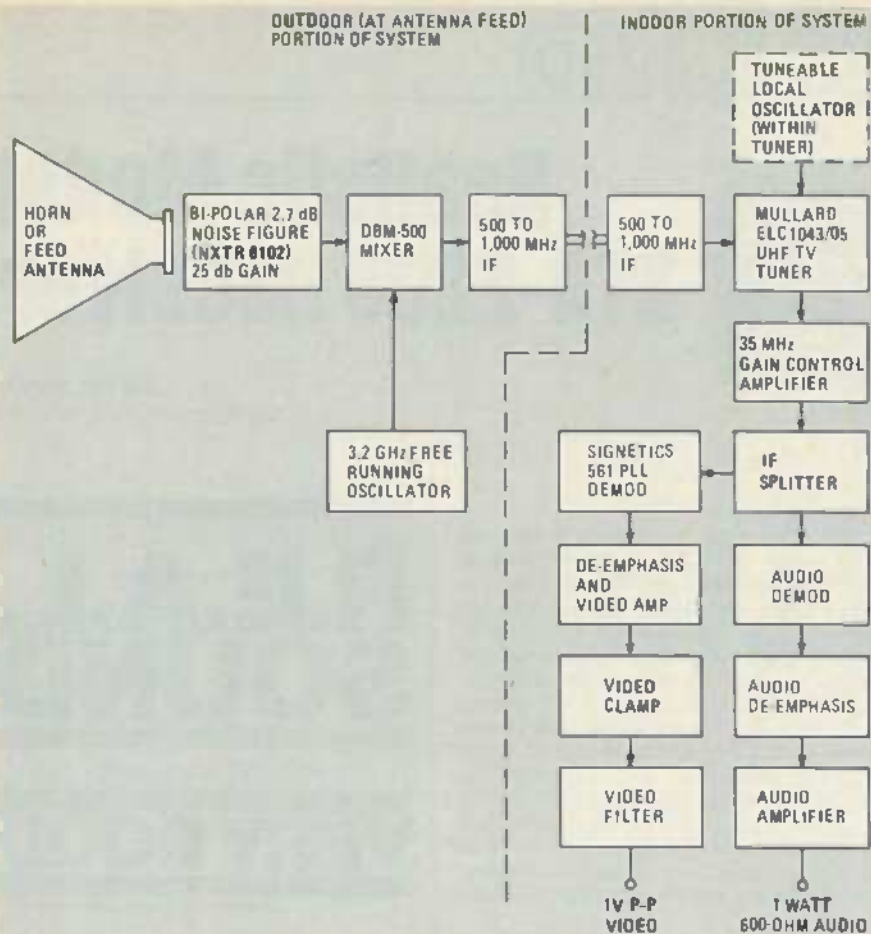

FIG. 3—MOST HOMEBREW TERMINALS place a lower grade LNA stage plus first mixer, local oscillator source and an IF stage or two at the feed antenna, coming down to the baseband demodulator through lower-cost 50-ohm cable at the high-IF (500-1,000 MHz) region. In this version, essentially patterned after English experimenter Steve Birkill, a Mullard ELC1043/05 (European) TV tuner is slightly modified as combination oscillator and mixer to translate high IF range down to 35-MHz region low IF. Birkill processes his 35-MHz IF to video through a Signetics 561 phase-locked-loop demodulator; a system that offers advantages for weak input level signals. Full block diagram is not shown at this time.

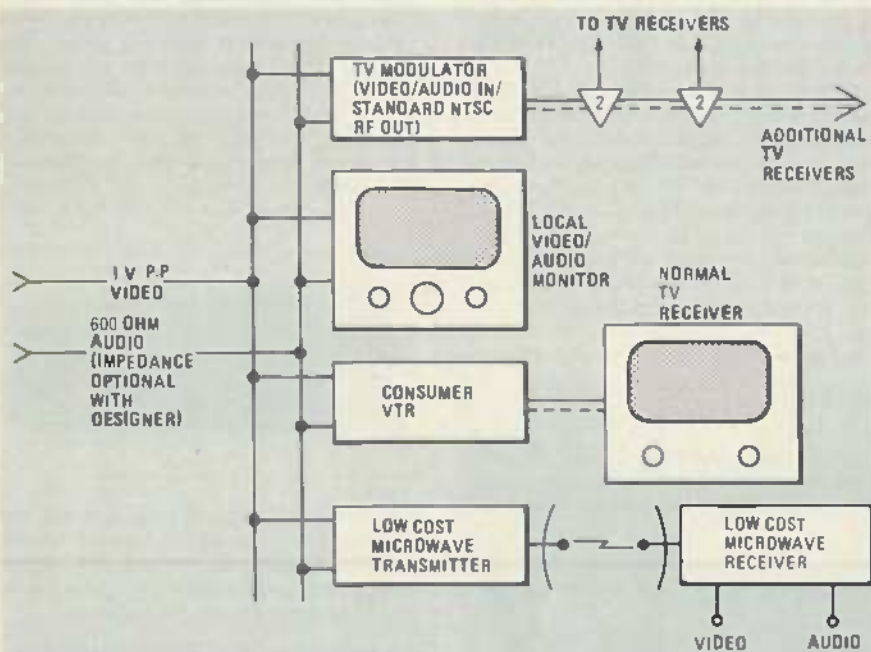

FIG. 4—VARIOUS METHODS OF DISPLAYING BASEBAND (i.e. demodulated) video and audio. Typical receiver produces 1V-P-P video and some usable level of audio (often at 600-ohm balanced although that is design decision of builder). Baseband signals will directly drive TV channel RF modulator, a high-quality video monitor (with audio display system built-in or separate), a consumer VTR (for recording or as loop-thru to use RF modulator), or low-cost (private) microwave system.

scratch) satellite TV receiver builders are using this approach because it eliminates all work at microwave frequencies in deriving the high local oscillator signal.

The Birkill Receiver approach, modified slightly, is shown in Fig. 3. As you can see, the LNA, the high-frequency local oscillator and mixer, plus a bulk gain stage operating in the 500-to-1,000 MHz region is mounted outside at the antenna. This simply means that what you feed "downstairs" to the remainder of the receiver, through coaxial cable, is (relatively speaking) low-frequency signals; in the 500-to-1,000 MHz region in this case. If the run is 100 feet or less, you can get by at these frequencies with RG-8 type coaxial cables whereas a similar run at 4 GHz requires 3/8-inch air-dielectric cable and special fittings.

Once indoors, the Birkill Receiver approach treats the signals contained in the 500-to-1,000 MHz IF bandwidth as a "group" and tunes them separately with a slightly modified (English, Mullard) UHF television tuner. The TVRO signals are 36 MHz wide (and of course still FM) and we need to convert them again (in frequency) down to a low enough IF where they can be detected. Experimenter Steve Birkill has found that an English Mullard type ELC1043/05 UHF TV tuner makes a dandy tunable second conversion system with only minor modifications. Unlike U.S. (of Canadian or Japanese, etc) UHF tuners designed for the American NTSC signals, the English (Mullard) tuner is capable of passing the full 36 MHz wide TVRO signal with only very minor modification. All American tuners checked have a 3 dB passband of not more than 10 to 11 MHz which simply means that they are not wide enough (even if modified) to handle the extra modulation/carrier width of the TVRO signal. Another advantage of the (European) UHF tuner, in this application, is that it has 20 dB of RF (500-1,000 MHz) gain and a quite respectable noise figure of under 5 dB. American market UHF tuners lack RF amplifier stages and consequently their front end noise figures are in the 12 dB and up region.

Birkill takes his low IF out at 35 MHz which allows him to use a Signetics 561 phase-locked-loop as a demodulator. Many of the commercial receivers also use phase-locked-loop demodulators, but Birkill's approach is unique since it allows the system user to change the effective bandwidth of the total system by varying the way the 561 is driven. This allows you to capture (that is, see) signals that are far weaker than would register on a standard 30- to 36-MHz wide IF satellite receiver; although admittedly the quality does suffer in the process. However, in his case, Steve Birkill has been able to produce very

*continued on page 65*

## Realistic Model STA-2200 Receiver



1

CIRCLE 106 ON FREE INFORMATION CARD

LEN FELDMAN  
CONTRIBUTING HI-FI EDITOR

REALISTIC AUDIO PRODUCTS ARE SOLD exclusively by the thousands of Radio Shack stores located throughout the United States and through their mail-order catalogs. The company has its own engineering staff, located in Fort Worth, Texas, to design the products which are then manufactured for them overseas. Their most sophisticated stereo receiver to date is the model STA-2200 shown in Fig. 1.

The gold-colored front panel has no conventional dial scale or pointer. Instead, a large, highly visible digital display indicates the frequencies selected. The display reads-out in 200-kHz increments for FM and in 10-kHz increments for AM and is associated with a true frequency-synthesis tuning scheme. The display also serves as a real-time digital clock, indicating the time of day (including "AM" or "PM" notations) when non-radio program sources are being heard, or even in the AM and FM mode when a CLOCK pushbutton located behind a cleverly arranged sliding door panel is depressed. Program functions, such as phono and auxiliary, are also designated by alphabetic notations in the display area, as in reception of stereo FM signals.

Sliding up the aforementioned panel (located at the left of the display) reveals additional buttons for setting the hour and the minute of the digital clock display, for dimming the intensity of the display, for turning off output-power and signal-strength LED displays and for activating the "station-memory" feature. When the MEMORY-SET button is pushed, you have five seconds in which to enter the tuned-to frequency of six AM or six FM stations (a total of twelve) by depressing one of six buttons located beneath the digital readout area. Just to the left of the sliding panel are tape monitor and dubbing lever switches for operation of two connected tape decks for dub-

bing from one to the other.

The upper right of the panel is equipped with several tuning option buttons. Pressing the auto-tuning UP or DOWN buttons makes the tuner scan in the desired direction until the next usable signal is reached. A second pair of buttons (equipped with arrows, like the first pair) can be used for manual tuning. (The tuner continues to move up or down in frequency so long as the button is held down.) Just below those, a SCAN button, when depressed, makes the tuner scan to each of the memorized station frequencies in sequence, stopping for five seconds at each station for auditioning. If you want to stop the scan sequence, press the HOLD button during the 5-second interval. A POWER on/off button is also located at this end of the panel.

The center of the lower section of the front panel contains two banks of LED's (10 LED's per bank), which serve as power-output meters. These LED's are calibrated in watts, referred to 8-ohm loads. Calibration is either 100 watts or 10 watts per channel maximum, depending upon the setting of a pushbutton. Additional pushbuttons in that cluster include a mute button for FM, A and B speaker selector buttons, a tone control defeat button, mono/stereo switch, an MPX high-blend filter switch, and a loudness switch.

Concentric volume and balance controls are located at the lower right corner of the panel, as is the usual headphone connection jack. To the left of the power LED display are bass and treble tone controls, and between them are a pair of pushbutton switches that determine the frequency at which the tone controls begin to boost or cut (150 Hz or 300 Hz for the bass, 3 kHz or 6 kHz for the treble). A program selector switch is located at the extreme left of the panel and, in addition to its expected settings (phono, AM, FM and aux), also has a

RADIO-ELECTRONICS AUDIO LAB

# R.E.A.L. SOUND

RATES

REALISTIC STA-2200

## VERY GOOD

Copyright © Gernsbeck Publications Inc., 1979

setting for Dolby FM. The receiver is equipped with a complete Dolby FM decoder circuit.

The rear panel of the STA-2200 is shown in Fig. 2. A line fuseholder and switched and unswitched AC receptacles are at the left. Nearby are spring-loaded color-coded speaker terminals for the two pairs of speakers. There are also RCA-type phono jacks for use when your speakers are equipped with permanent cables terminating in matching phono plugs. Preamp-out/main-amp-in jacks are interconnected by a pair of removable wire jumpers.

Two sets of tape-out/tape-in jacks are augmented by European type DIN multi-contact connectors. Other inputs (auxiliary and magnetic phono) are at the lower right of the panel, far removed from any AC hum fields, and a



2

chassis ground terminal is located near the phono input jacks. Antenna screw terminals for AM, 75-ohm and 300-ohm FM antenna connections are provided along with a pivotable AM loopstick ferrite bar antenna.

### Construction and circuit highlights

An internal view of the STA-2200 chassis is shown in Fig. 3. The FM front-end uses a dual-gate MOS FET and is tuned by variable-capacitance diodes, controlled by a microprocessor. The FM IF section uses 3 IC's and three

### MANUFACTURER'S PUBLISHED SPECIFICATIONS:

#### FM TUNER SECTION:

Usable Sensitivity: mono, 1.8  $\mu$ V (10.3 dBf). Signal-to-Noise Ratio: mono, 68 dB. Image Rejection: 75 dB. Capture Ratio: 1.5 dB. IF Rejection: 95 dB. AM Suppression: 55 dB. Harmonic Distortion: mono, 0.2%; stereo, 0.3%. Stereo Separation, 1 kHz: 48 dB.

#### AM TUNER SECTION:

Sensitivity: 10  $\mu$ V. Distortion: 1.0%. Image Rejection: 45 dB. IF Rejection: 47 dB. AM Fidelity: 40 Hz to 3,000 Hz,  $\pm$ 6 dB.

#### AMPLIFIER SECTION:

Power Output: 60 watts per channel into 8 ohms, 20 Hz to 20 kHz. Rated Harmonic Distortion: 0.02%. Input Sensitivity, for full output: phono, 2.2 mV; high level, 160 mV. Phono Overload: 200 mV. Signal-to-Noise Ratio: phono, 85 dB; high level, 75 dB. Bass Control Range:  $\pm$  10 dB at 50 Hz or 100 Hz. Treble Control Range:  $\pm$  10 dB at 10 kHz or 20 kHz.



linear-phase ceramic filters. Quadrature detection is used to recover the FM composite audio signal which is then fed to a phase-locked-loop stereo decoder. The digital tuning is controlled by a phase-locked-loop CMOS IC. MOS FET's are also used in the power amplifier section. Automatic protection circuitry protects against voltage surges, overloads, speaker shorts, and thermal overheating.

### FM performance measurements

Table 1 summarizes performance measurements made for the FM section of the receiver. Frequency response in mono and stereo FM was extremely flat, with very little evidence

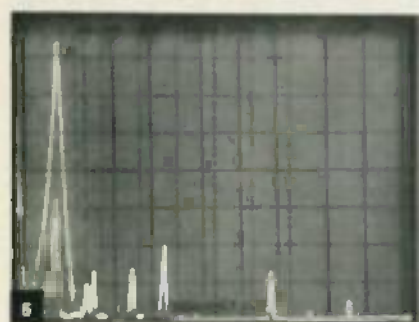
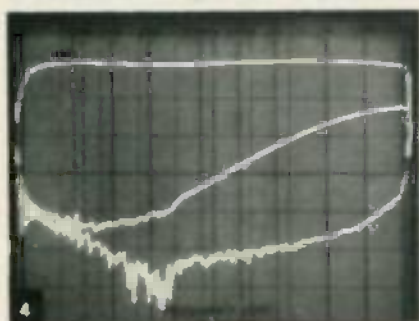
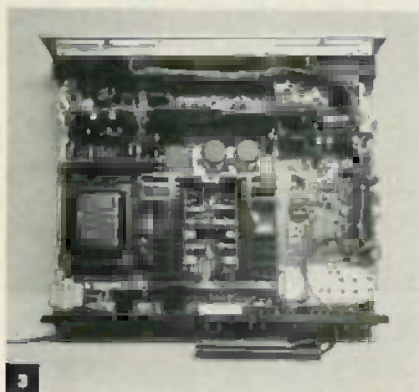

of the roll-off often encountered at around 15 kHz (the upper limit of FM transmission) in many tuners and receivers. Signal-to-noise and distortion in mono and stereo FM were not as good as are usually encountered with conventionally-tuned FM tuner sections, however. Figure 4 illustrates the frequency response of the FM section, as well as the stereo FM separation characteristics of the multiplex decoder without the use of the blend filter (lower trace) and with the MPX blend filter activated (center trace). Figure 5 is a composite spectrum-analyzer sweep photo used to illustrate the nature of the cross-talk fed into the unmodulated channel from the modulated one when a

RADIO-ELECTRONICS PRODUCT TEST REPORT		
TABLE I		
Manufacturer: Reallistic (Radio Shack)	Model: STA-2200	
FM PERFORMANCE MEASUREMENTS		
<b>SENSITIVITY, NOISE AND FREEDOM FROM INTERFERENCE</b>	<b>R-E Measurement</b>	<b>R-E Evaluation</b>
INI sensitivity, mono: ( $\mu$ V) (dBf)	1.8 (10.3)	Very good
Sensitivity, stereo ( $\mu$ V) (dBf)	7.0 (22.1)	Good
50 dB quieting signal, mono ( $\mu$ V)	3.0 (14.7)	Very good
50 dB quieting signal, stereo ( $\mu$ V)	47.0 (38.6)	Fair
Maximum S/N ratio, mono (dB)	68	Fair
Maximum S/N Ratio, stereo (dB)	65.5	Good
Capture ratio (dB)	1.5	Very good
AM suppression (dB)	56	Good
Image rejection (dB)	75 dB	Good
I-F rejection (dB)	97 dB	Good
Spurious rejection (dB)	83 dB	Good
Alternate channel selectivity (dB)	75 dB	Very good
<b>FIDELITY AND DISTORTION MEASUREMENTS</b>		
Frequency response, 50Hz to 15 kHz ( $\pm$ dB)	0.5	Excellent
Harmonic distortion, 1 kHz, mono (%)	0.12	Very good
Harmonic distortion, 1 kHz, stereo (%)	0.15	Very good
Harmonic distortion, 100 Hz, mono (%)	0.14	Excellent
Harmonic distortion, 100 Hz, stereo (%)	0.26	Good
Harmonic distortion, 6 kHz, mono (%)	0.11	Excellent
Harmonic distortion, 6 kHz, stereo (%)	0.23	Very good
Distortion at 50 dB quieting, mono (%)	0.37	Excellent
Distortion at 50 dB quieting, stereo (%)	0.30	Very good
<b>STEREO PERFORMANCE MEASUREMENTS</b>		
Stereo threshold ( $\mu$ V)	7.0 (22.1)	Very good
Separation, 1 kHz (dB)	51.0	Superb
Separation, 100 Hz (dB)	46.0	Excellent
Separation, 10 kHz (dB)	36.0	Very good
<b>MISCELLANEOUS MEASUREMENTS</b>		
Muting threshold ( $\mu$ V)	7.0 (22.1)	Good
Dial calibration accuracy ( $\pm$ kHz at MHz)	Perfect	Superb
<b>EVALUATION OF CONTROLS, DESIGN, CONSTRUCTION</b>		
Control layout		Excellent
Ease of tuning		Superb
Accuracy of meters or other tuning aids		Superb
Usefulness of other controls		Very good
Construction and internal layout		Very good
Ease of servicing		Good
Evaluation of extra features, if any		Excellent
<b>OVERALL FM PERFORMANCE RATING</b>		Very good

5-kHz signal is used to modulate one channel. The desired 5-kHz output from the modulated channel is the tall peak at the left of the display. (The display is linear from 0 Hz to 50 kHz with 5 kHz per horizontal division.) Contained within this peak is the second peak, at lower amplitude, which represents the 5-kHz component observed at the output of the unmodulated channel, while to the right of this are distortion components as well as the expected 19- and 38-kHz subcarrier components.

The action of the Dolby FM decoder circuitry is best illustrated by Fig. 6. Each sweep (logarithmic, from 20 Hz to 20 kHz) was made at a different level of modulation and, as expected, the upper sweep is virtually flat while correspondingly lower level sweeps show the Dolby high-frequency attenuation required to restore flat response at those lower levels to signals that had been conversely boosted during transmission. The FM generator was set for 25 microsecond pre-emphasis in making these plots.

Frequency response in AM was remarkably good compared with the AM sections of many stereo receivers that we have tested in the past. As can be seen from the response plot of Fig. 7, the -6-dB points occurred at approximately 30 Hz and 4 kHz which, though hardly "hi fi" compares very favorably with the usual 2.5- to 3-kHz roll-off normally found on AM tuners

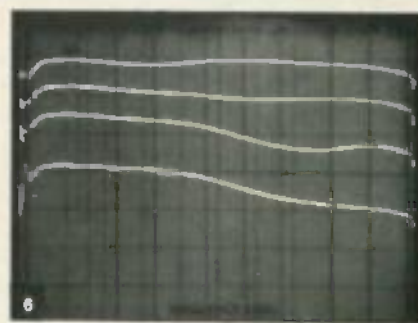

built into high-fidelity receivers.

### Amplifier and preamplifier section measurements

Table 2 is a summary of measurements made for the power amplifier and preamplifier sections of the STA-2200 Receiver. The unit seems quite conservatively rated in terms of power output, as well as rated distortion, delivering a clean 72 watts per channel at mid-frequencies and just under 70 watts per channel at the 20 Hz and 20 kHz frequency extremes for its rated harmonic distortion of 0.02%. Since no ratings were provided for 4-ohm loads, we did not measure maximum output for this load condition. We did, however, operate the amplifier for long periods into 4-ohm speaker systems without encountering

any thermal or shut-down problems.

While our signal-to-noise measurements for both phono and high-level inputs are made in accordance with the new IHF Amplifier Measurement Standards (and cannot therefore be compared with Radio Shack's published specifications), the 77-dB S/N measurement in

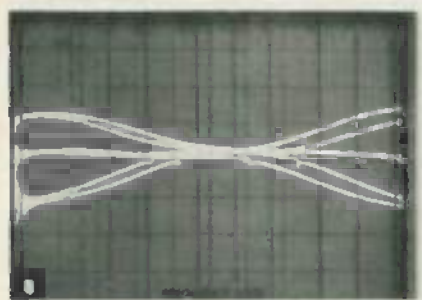
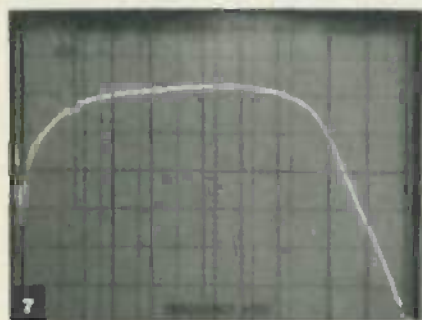

phono and the 81-dB measurement for the high-level inputs (both A-weighted and referred to 1-watt output) compare very favorably with measurements obtained for other receivers in this, or even higher-priced categories. Phono overload capability exceeded Radio Shack's claimed figure of 200 mV by a wide margin and there is absolutely no danger of overdriving the first stages of the phono equalizer section of the receiver.

Range of the variable-turnover bass and treble controls is illustrated in the spectrum analyzer sweep photo of Fig. 8. Sensitivity of the analyzer was 10 dB of amplitude between horizontal lines and sweep is logarithmic from 20 Hz to 20 kHz.

### Summary

Our overall product analysis of the Realistic STA-2200 will be found in Table 3. On the whole, the receiver embodies a great many innovative design features, most of them concerned with ease of use and convenience of accurate tuning. In our bench and listening tests, the receiver ran very cool under all listening conditions, including extended periods when it was operated near its clipping point.

The purist audiophile may not think much of the fancy tuning schemes, the digital and LED displays and the time clock, but we suspect that the music enthusiast who wants ease of use and welcomes a "conversation piece" such as the built-in digital clock will find the STA-2200 appealing. The less-than-spectacular signal-to-noise performance of the FM section, will probably not prove to be a limiting factor in FM listening. Few stations we know of actually transmit a signal-to-noise or dynamic range ratio much above 60 dB. For all of these reasons, and because of its clever design and pleasing layout, we have assigned a VERY GOOD R.E.A.L. rating to the Realistic STA-2200.

R-E

## RADIO ELECTRONICS PRODUCT TEST REPORT

TABLE 2

Manufacturer: Realistic (Radio Shack)

Model: STA-2200

### AMPLIFIER PERFORMANCE MEASUREMENTS

	R-E Measurement	R-E Evaluation
<b>POWER OUTPUT CAPABILITY</b>		
RMS power/channel, 8-ohms, 1 kHz (watts)	72.0	Excellent
RMS power/channel, 8-ohms, 20 Hz (watts)	69.0	Very good
RMS power/channel, 8-ohms, 20 kHz (watts)	69.0	Very good
RMS power/channel, 4-ohms, 1 kHz (watts)	N/A	N/A
RMS power/channel, 4-ohms, 20 Hz (watts)	N/A	N/A
RMS power/channel, 4-ohms, 20 kHz (watts)	N/A	N/A
Frequency limits for rated output (Hz/kHz)	10-30	Excellent
Dynamic headroom (dB)	1.2	Non-rated
<b>DISTORTION MEASUREMENTS</b>		
Harmonic distortion at rated output, 1 kHz (%)	0.014	Very good
Intermodulation distortion, rated output (%)	0.035	Very good
Harmonic distortion at 1-watt output, 1kHz (%)	0.017	Very good
Intermodulation distortion at 1-watt output (%)	0.018	Good
<b>DAMPING FACTOR AT 8 OHMS, 50 Hz</b>	67	Very good
<b>Phono preamplifier measurements</b>		
Frequency response (RIAA $\pm$ dB)	0.5	Good
Maximum input before overload (mV)	235	Excellent
Hum/noise, A-weighted, referenced to 1-watt or 0.5-volt output, for 5 mV input (dB)	77	Very good
<b>High level input measurements</b>		
Frequency response (Hz-kHz, $\pm$ dB)	12-30, 1.0	Very good
Hum/noise, A-weighted, referenced to 1-watt or 0.5-volt output, 0.5-volt input (dB)	81	Excellent
Residual noise, A-weighted minimum volume, referenced to 1-watt output (dB)	82	Very good
<b>TONAL COMPENSATION MEASUREMENTS</b>		
Action of bass and treble controls	See Fig. 9	Excellent
Action of secondary tone controls	N/A	N/A
Action of high and low cut filters	N/A	N/A
<b>COMPONENT MATCHING MEASUREMENTS</b>		
Input sensitivity, Phono 1/Phono 2, referenced to 1-watt or 0.5-volt output (mV)	0.3/	
Input sensitivity, high level referenced to 1-watt or 0.5-volt (mV)	18	
Output level, tape outputs, at rated output (mV)	160	
Output level, headphone jack, at rated output (mV or mW)	307mV/8 ohms	
<b>EVALUATION OF CONTROLS, CONSTRUCTION AND DESIGN</b>		
Adequacy of program source and monitor switching		Excellent
Adequacy of input facilities		Very good
Front panel layout		Excellent
Action of controls and switches		Superb
Design and construction		Excellent
Ease of servicing		Good
<b>OVERALL AMPLIFIER PERFORMANCE</b>		Very good

TABLE 3

### OVERALL PRODUCT ANALYSIS

Retail price	\$599.95
Price category	Medium
Price/performance ratio	Very good
Styling and appearance	Excellent
Sound quality	Very good
Mechanical performance	Excellent

**Comments:** Last year, Radio Shack's most expensive model sold for the same price as the STA-2200, \$599.95. It was a 120-watt-per-channel model, with conventional tuning. This year, their top model has given up power in favor of a very sophisticated FM and AM tuning system, known as frequency synthesis. This tuning method guarantees center-of-channel tuning that is fully as accurate as the tuning of the broadcast station.

The digital display, the 12-station memory (6 for FM, 6 for AM), the use of the display as a time clock plus its alphabetic designations of program source, stereo FM signal reception, and the like all add to the cost of the unit, so that, in effect, Radio Shack has traded power for convenience features and ease of tuning. The STA-2200 is a joy to use. The LED power "meters," and LED signal-strength indicators, are far more accurate and easier to interpret than are mechanical tuning and power output meters.

Some small sacrifices result from the frequency synthesis approach. The maximum signal-to-noise ratio in mono FM is less than 70 dB. Varactor tuning simply does not yield the same signal-to-noise performance as variable capacitor tuning. The Realistic STA-2200 delivers clean, natural sound in phono and tape reproduction. Tone controls are well designed and the variable turnover feature is a welcome one. A sub-sonic filter would have been a welcome addition, however. A word of commendation is in order for the excellent AM section which had surprisingly good frequency response.



## BETTER Pick-up Arm PERFORMANCE

**LEN FELDMAN**  
CONTRIBUTING HI-FI EDITOR

A RECENT TRIP TO SWITZERLAND INCLUDED a visit to the well-known Thorens Company, a few miles outside of Zurich. There, several audio experts and I, were treated to a seminar that explored many of the myths associated with turntable design and performance. Admittedly, any manufacturer is going to make a strong point for his own design approaches to a product, but much of what we learned was backed up by solid theory. In any record playing system, we deal with two major elements: the turntable with its drive system, and the pickup arm and cartridge combination. In this article, we will discuss some of the design considerations involved in insuring optimum pickup arm/cartridge interface. In a future article we will discuss design approaches for the turntable and its drive system.

In recent years we have seen significant improvements in both turntable designs (to reduce rumble, improve speed precision and to minimize speed variations known as wow-and-flutter) and cartridge designs (to improve frequency response, lower tracking distortion and reduce mass). While design improvements of turntable and cartridges can be considered independently of each other, design improvements in pickup arms cannot be analyzed without considering the total playback system.

Tracking characteristics of an arm at very low frequencies (below 20 Hz) are influenced primarily by arm resonance

*The design of the phonograph pickup arm plays an important part in the overall performance of a high-fidelity system. Len gives details on the Thorens approach to pickup arm design.*

and record warp. Arm resonance is the vibration of the arm/cartridge assembly that results while the stylus tracks the record. Record warp can affect arm tracking by altering instantaneous stylus pressure, as shown in Fig. 1. As the stylus rides up the record warp, the inertia of the arm mass causes the downward stylus force to increase. Conversely, when the pickup rides down the warp, the inertia of the pickup arm mass causes the down-

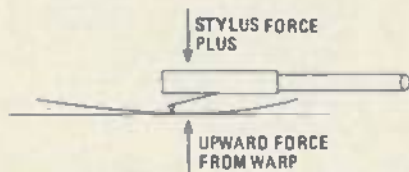

FIG. 1—RECORD WARP affects stylus pressure—increasing it as stylus rides up and decreasing it as stylus rides down the warp.

ward stylus force to decrease. This varying stylus force, especially when the stylus rides down the warp, often results in mistracking and increased distortion as the stylus loses intimate contact with the record groove. Reducing the effective pickup arm mass would lower the inertial forces affecting stylus force as warped records are tracked and would, therefore, improve tracking and provide for lower distortion when playing warped records.

Messrs. Happ and Karlov, in a paper titled "Record Warps and System Playback Performance", analyzed the velocity spectrum of record warp using a repre-

sentative sampling of records. The results of their work are shown in Fig. 2. From this graph we see that the velocity of record warp is greatest between 0.5 Hz and 7 Hz. To minimize pickup arm mistracking caused by record warp, the arm-resonance frequency should be between 10 Hz and 12 Hz, or above the frequencies that cause maximum record warp velocities. However, arm resonance must be below the 20-Hz lower limit of audio modulation on the record.

The chief factors that influence the resonant frequency of an arm/cartridge combination are the weight of the cartridge, the effective mass of the pickup arm, and the compliance of the cantilever arm of the pickup cartridge. The way these factors affect arm resonant frequency is illustrated in Fig. 3. The curves

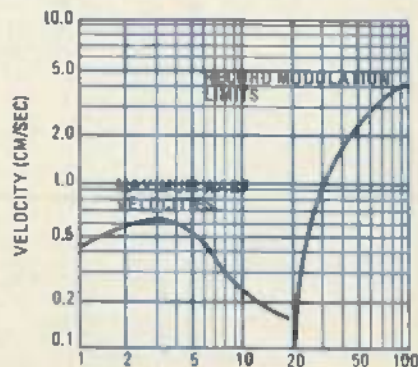

FIG. 2—RECORD WARP velocities peak at around 0.6 cm/sec at about 3.5 Hz.

show how arm resonant frequency changes with respect to the effective mass of the pickup arm and with the compliance of the cartridge used. Note that the resonant frequency varies inversely with effective mass and with compliance. Increasing either of these two parameters decreases the resonant frequency of the arm.

For example, if we have an arm with an effective mass of 15 grams and add a lightweight cartridge that weighs only 3 grams it has a compliance of  $30 \times 10^{-6}$  cm/dyne. As shown in Fig. 4, the effective mass of this arm/cartridge combination would be 18 grams (15 grams for the arm plus 3 grams; the weight of the cartridge). The resonant frequency of this

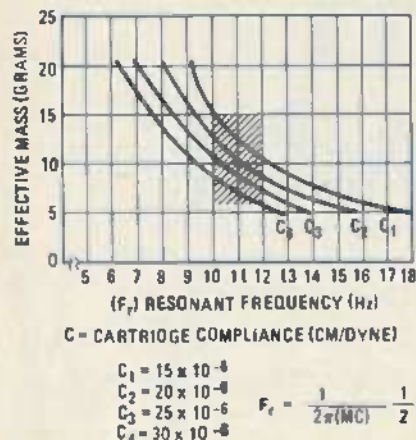

FIG. 3—RESONANT FREQUENCY of arm and Cartridge are affected by three factors.

arm/cartridge combination would be 7.5 Hz. This frequency borders on the range of greatest velocity caused by record warp (as previously shown in Fig. 2).

Three grams is a rather light weight for a cartridge, so suppose we increase its weight to 7 grams. Total effective mass of the combination would now be 22 grams (see Fig. 5), and the new resonant frequency of the arm/cartridge combination would be 6.3 Hz, or very close to the maximum velocity of record warps.

Most popular phono pickup cartridges do weigh between 3 and 7 grams and ideally, if we are dealing with cartridges whose compliance ranges between 15 and  $30 \times 10^{-6}$  cm/dyne (also typical) the effective mass of a pickup arm that would keep resonant frequencies in the range

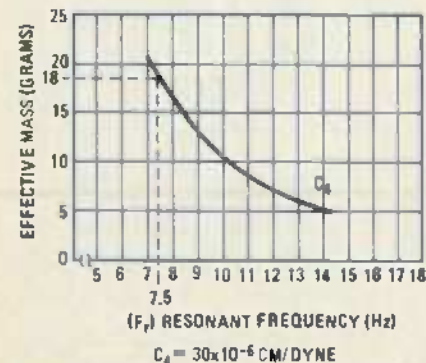

FIG. 4—RESONANT FREQUENCY varies with arm mass and cartridge compliance.

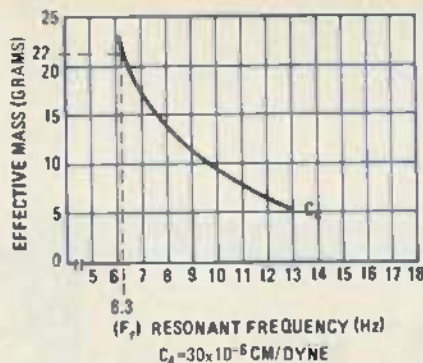
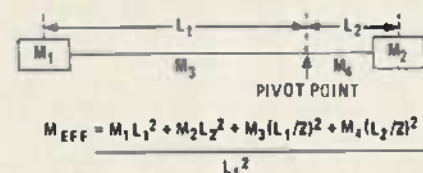

FIG. 5—HOW INCREASING CARTRIDGE weight affects arm mass and frequency.

from 7.6 Hz to 12 Hz is between 6 and 10 grams (not including the weight of the cartridge).

To keep the effective mass of a pickup arm within this specified range, only certain factors in the arm design may be altered, while others must remain constant. The various dimensions and masses involved are illustrated in Fig. 6. For example, the length of the pickup arm tube from stylus tip to pivot center ( $L_1$ ) is fixed by the record diameter and the overall dimensions of the turntable system. The mass of the pickup cartridge, one of the factors determining the value of  $M_1$  in Fig. 6, is determined by the cartridge manufacturer and, as we have stated, generally ranges from 3 to 7 grams. The remaining factors that lend themselves to redesign are the mass of the headshell assembly (part of  $M_1$ ), the



- $L_1$  = STYLUS TIP TO PIVOT CENTER DISTANCE
- $L_2$  = PIVOT CENTER TO COUNTERWEIGHT MASS CENTER DISTANCE
- $M_1$  = MASS OF HEADSHELL PLUS CARTRIDGE
- $M_2$  = MASS OF COUNTERWEIGHT ASSEMBLY
- $M_3$  = MASS OF PICKUP ARM TUBE
- $M_4$  = MASS OF COUNTERWEIGHT TUBE

FIG. 6—THE SIX FACTORS involved in the design of a pickup arm.

mass of the pickup arm tube ( $M_3$ ), the mass of the counterweight tube ( $M_4$ ) and its length ( $L_2$ ), and the mass of the counterweight itself, ( $M_2$ ).

The degree to which the mass of the counterweight may be altered and, to some extent, the degree to which the length of the counterweight tube may be altered, is limited by the weight range of popular pickup cartridges. The counterweight, after all, serves the primary function of balancing out the weight of the cartridge, shell and forward part of the pickup arm. The only elements of the structure, then, that may be dealt with in attempting to lower effective mass are that portion of  $M_1$  represented by the headshell and the mass of the pickup arm itself ( $M_3$ ).

For example, the headshell mass can be reduced by using a light material and eliminating the screw collar that normally secures the headshell to the pickup arm tube. That approach, however, makes it difficult to interchange pickup cartridges.

An alternate solution (and one that Thorens eventually adopted) is to move the screw collar closer to the pivot point of the arm. By doing so, the mass is moved closer to the pivot point. In effect, because the formula for effective mass includes the term  $M_3 (L_1/2)^2$ , and since  $L_1$  is now shorter, there is a significant decrease in overall effective mass. Since the mass of the pickup arm has been decreased, the mass of the balancing counterweight can also be decreased, further reducing the effective pickup arm mass (see Fig. 7).

The pickup cartridge must, of course, be rigidly connected to the pivot assembly. The material of the arm must be rigid but also light in weight. According to

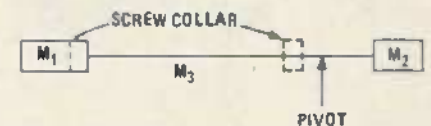

FIG. 7—EFFECTIVE MASS of pickup arm is lowered in new Thorens design by moving the screw collar closer to the pivot point.

Thorens (and more and more turntable manufacturers seem to be coming to the same conclusion of late), a straight pickup-arm tube design provides maximum stiffness and also lowest mass. Furthermore, in a straight tube design the rotational force caused by mass displacement about the vertical pivot points need not be compensated for with additional counterweight lateral balancers, as is done with some S-shaped pickup arms.

Thorens' new pickup arms ("Isotrack" arms), have been designed with all of the foregoing in mind. A thin-wall, straight anodized aluminum tube is used and the screw collar is located close to the pivot point. Instead of removing the headshell to interchange cartridges, the user purchases as many forward tube portions as he or she wishes, mounting each cartridge in a separate unitized forward tube structure.

The arm's effective mass turns out to be approximately 7.5 grams (exclusive of the cartridge used). Figure 8 compares the range of arm resonance that might be expected from a typical arm with an effective mass of 15 grams when used with cartridges weighing between 3 and 7 grams and having compliances of between 15 and  $30 \times 10^{-6}$  cm/dynes with the resonance range that will result if those same cartridges are used in the Thorens Isotrack arm. For the typical higher-mass arm, resonant frequencies range from 6.3 Hz to 9.5 Hz, after adding in the weight of the cartridge to the effective arm mass. For the Isotrack arm, resonance falls

between 7.6 Hz and 12 Hz, thanks to its lower effective mass.

In addition to its lower mass, the Thorens Isotrack arm has a low 25-milligram (maximum) pivot friction in both the vertical and horizontal planes. Anti-skating is applied through a magnet arrangement that has the advantage over the familiar spring or weight arrangement that tends to introduce additional and variable fric-

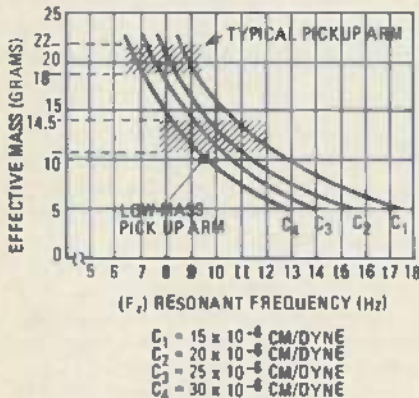

FIG. 8—A COMPARISON OF RESONANCES of two pickup arms of different weights.

tion components as the arm traverses the record.

According to Thorens, there is one additional advantage to be gained through the use of a low-mass arm. That is, lower susceptibility to vibration and shock from outside sources.

There is one other important consideration that should be discussed in any analysis of pickup arm design. That is the configuration of the bearing assembly and the length of the arm itself. Because so many of the records we play are warped, the bearing pivot point should ideally lie in the same plane as the playing surface. With such positioning, the longitudinal displacements caused by record warp are kept to a minimum, and the resulting wow-and-flutter components are lower. We are not discussing the wow-and-flutter that is inherent in the turntable drive system itself (that will be discussed next month). Rather, we are discussing that wow-and-flutter component that is generated entirely by vertical motion of the cartridge stylus as it is lifted and lowered by a warped record. Figure 9 illustrates this effect as it occurs with a pickup arm of normal length. The closer the pivot point is to the level of the record surface, the lower the wow and flutter produced by warped records. Extremely high levels of wow-and-flutter occur with short-arm designs that have a relatively high bearing-pivot point. Some of the so-called tangentially tracking arms that are available today have short arms, simply because tracking-angle error (the main reason for attempting a tangential-tracking arm in the first place) is eliminated in such designs. (The arm and cartridge cantilever assembly are always tangent to the groove being played). After investigating this approach, Thor-

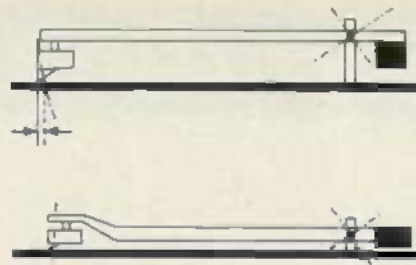

FIG. 9—WOW AND FLUTTER caused by record warp depends on height of pivot above record. Bottom design shows lower pivot.

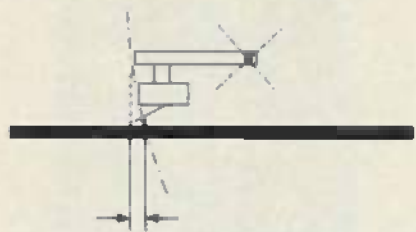

FIG. 10—RECORD-INDUCED WOW-AND-FLUTTER can be reduced in designs that have the arm pivot moved closer to the cartridge head.

ens concluded that while tangential arms are certainly feasible, the additional drive requirements for such arms make them too complicated to be practical.

In any case, referring once more to the wow-and-flutter problem inherent in short-arm designs (including the tangentially tracking ones currently available), consider the short, 4-cm arm constructed as shown in Fig. 10. The wow-and-flutter added by a warped record to that inherent in the turntable drive system itself works out to be:

TOTAL WARP EXCURSION	ADDED WOW-AND-FLUTTER
1 mm	0.12%
2 mm	0.24%
3 mm	0.36%

If we assume that a high-quality turntable exhibits its own basic wow and flutter component of around 0.05%, then with a 1 millimeter record warp the total wow-and-flutter will rise to 0.17%. A quick survey of your own records will show that you have very few that have less than 1 millimeter of warpage!

It is clear that the design of a complete turntable system involves many diverse factors, not the least of which is the fact that most phonograph records are less-than-perfect. To design a record playing system on the premise that records that will be played on it are perfectly flat, have completely concentric holes, and will be played in an environment that is totally free of outside vibration or noise is to ignore the real-world situation. In the next installment, we will talk about rumble, wow-and-flutter, mounting suspensions, and other factors relating to the turntable platter itself and its drive system. We will also try to show why one manufacturer's turntable, that has a -70 dB rumble figure, may, in fact, produce more rumble than another turntable that has a -50 dB rumble figure. R-E

## TV RECEIVERS

continued from page 59

high quality reception from the Russian stationary series of satellite transponders although he is working with signals 7-9 dB weaker than we have available here from North American domestic satellites, and he has acceptable (if not high quality) pictures from the much weaker Intelsat satellites (they run from 12 to 15 dB weaker than our domestic satellites). The balance of his receiver approach is pretty standard since once you have baseband video and audio there is only about one way to process it for conversion back to RF as an AM format signal.

To some people, being at baseband with the signal may seem like ending up at the wrong place. To view baseband directly, you feed the video and audio signals into a video "monitor" and a speaker. Not everyone has a video monitor of course and some means of getting the baseband signal back to a standard NTSC television channel (with the video portion amplitude modulated) is required.

A word about viewing the signal(s) at pure baseband; i.e. into and through a video monitor. This is the ultimate (high class) viewing technique since the baseband signals are of very high quality (48- to 54-dB signal to noise) and purity. However, this generally limits you to viewing the signals on a single monitor since video monitors tend to be expensive.

In Fig. 4 we have several methods suggested to get the baseband back to an RF channel. Clearly the baseband video and audio must be used to modulate a TV channel modulator device. Numerous circuits for these devices have appeared in *Radio-Electronics* through the years. One of the easiest ways to modulate back to RF is to use a LM1889 IC which is a complete (TV channel 3 or 4) RF carrier generator/modulator intended for TV games and home VTR's. If you already have a home VTR, you can simply loop the baseband video and audio to the home VTR's "camera" and "audio" inputs. This turns the VTR into a modulator for you and you can then watch the satellite TV signals on multiple TV receivers, connected to the VTR modulator through 75-ohm coaxial cable (as in a miniature TV distribution system). R-E

 **American Heart Association**  
WE'RE FIGHTING FOR YOUR LIFE

## SOUND-ACTIVATED LAMP DIMMER

MY NEW IDEA CONCERNS THE USE OF MOTOROLA'S MOC3011 opto-isolated triac driver. The triac driver consists of a LED and an optically coupled bilateral switch (better known as a DIAC). This device permits low-voltage control signals to control high-voltage, high-power loads. It essentially allows the user to create a solid-state relay for a fraction of the cost.

I wanted to make a simple and inexpensive device capable of sound modulating the intensity of a light source using a microphone built into the case. The device that I designed employs a conventional light dimmer circuit in addition to the sound activation circuit. The light dimmer may be used either independently of or in conjunction with the sound



In addition to using this unit to produce scary effects for Halloween and cause your Christmas tree lights to dance with the Christmas music, you can also use this device to produce unique DISCO lighting effects with just about any lamp in the house. Several units placed around the room create a wild effect and there is no required connection to a sound source.—David L. Holmes

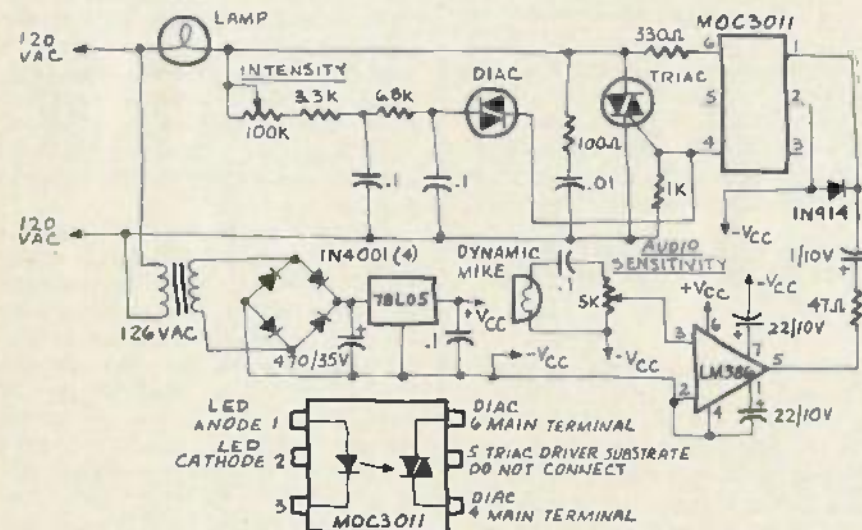

circuit. When used separately, the AUDIO SENSITIVITY control is set to minimum and the light dimmer is used in the conventional manner. When the light dimmer is activated by sound the 100K pot sets the minimum intensity that will remain in the absence of sound and return to after it has been triggered to full intensity by the sound section. This feature is made possible by the MOC3011. The signal that controls the triac in the light dimmer is so low that it does not harm the bilateral switch in the MOC3011. Furthermore, when the bilateral switch in the MOC3011 triac driver is triggered by the LED, it causes the triac to conduct fully and override the preset light dimmer setting.

The construction of the control unit is simple and straightforward. If circuit as-

sembly is done using point-to-point wiring rather than a circuit board. Use extreme caution when wiring that portion of the circuit which is connected to the 120-volt power line. Be sure that during the wiring of the triac driver (MOC3011), no connection of any kind is made to pin 5. Set the microphone element into a hole drilled in the top of the case and secure it with a silicon rubber compound. The audio gain and light dimmer controls were placed near the microphone element to allow adequate separation between the low-voltage section and the 120-volt power line. A chassis-mounted power socket was used as a convenient way to make the device flexible in use. If a high-power load is anticipated, be sure that adequate heat sinking is provided for the triac.

## NEW IDEAS

This column is devoted to new ideas, circuits, device applications, construction techniques, helpful hints, etc.

All published entries, upon publication, will earn \$25 plus a Circuit Board Holder, Standard Base and Tray Base Mount from Panavise Products, Inc. (See photo below.) Selections will be made at the sole discretion of the editorial staff of Radio-Electronics.



I agree to the above terms and grant Radio-Electronics Magazine the right to publish my idea. I declare that the attached idea is my own original material and that its publication does not violate any other copyright. I also declare that this material had not been previously published.

Title of Idea

Signature

Print Name

Date

Street

City

State

ZIP

Mail your idea along with this coupon to:

New Ideas  
Radio-Electronics  
200 Park Ave. South  
New York, NY 10003



# BUY ONE of these great professional books and GET ONE FREE

(values up to \$60.00) when you join the **COMPUTER PROFESSIONALS' BOOK CLUB**



Choose any one of these books at the special club discount, and select any other as your gift Free of Charge when you enroll:

**AUTOMATIC DATA PROCESSING HANDBOOK**  
 Edited by The Diebold Group, Inc.  
 168078 Pub. Pr., \$38.95 Club Pr., \$25.75

**PROGRAMMING LANGUAGES** By A. B. Tucker, Jr.  
 856158 Pub. Pr., \$22.00 Club Pr., \$16.50

**MINICOMPUTER SYSTEMS, 2nd Ed.** By R. H. Eckhouse  
 787026 Pub. Pr., \$21.95 Club Pr., \$16.50

**MICROCOMPUTERS/MICROPROCESSORS: Hardware, Software & Applications** By J. L. Milburn & P. N. Julich  
 771495 Pub. Pr., \$22.50 Club Pr., \$16.50

**MICROPROCESSOR APPLICATIONS MANUAL**  
 By Motorola, Inc.  
 435278 Pub. Pr., \$38.00 Club Pr., \$26.50

**THE 8080A BUGBOOK: MICROCOMPUTER INTERFACING AND PROGRAMMING** By P. R. Rony, D. G. Larsen & J. A. Titus  
 783845 Pub. Pr., \$9.95 Club Pr., \$8.45

**MICROCOMPUTER-BASED DESIGN** By J. Peetman  
 481380 Pub. Pr., \$26.50 Club Pr., \$18.95

**DATA BASE DESIGN** By G. Wiederhold  
 70130X Pub. Pr., \$24.50 Club Pr., \$18.25

**PRINCIPLES OF INTERACTIVE COMPUTER GRAPHICS, 2nd Ed.** By W. M. Newman & R. F. Sproull  
 463387 Pub. Pr., \$24.95 Club Pr., \$19.95

**PROGRAMMING FOR MINICOMPUTERS** By J. C. Clulley  
 78549X Pub. Pr., \$17.50 Club Pr., \$13.50

**REAL-TIME PROGRAMMING WITH MICROCOMPUTERS** By R. C. Turner  
 786372 Pub. Pr., \$18.95 Club Pr., \$13.95

**MEMORY DESIGN: Microcomputers and Mainframes** By Electronics Magazine  
 191549 Pub. Pr., \$18.50 Club Pr., \$15.50

**HOW TO DESIGN AND BUILD YOUR OWN CUSTOM TV GAMES** By D. L. Heiserman  
 786585 Pub. Pr., \$14.95 Club Pr., \$11.95

**HANDBOOK OF OPERATIONAL AMPLIFIER CIRCUIT DESIGN** By D. F. Stout, edited by M. Keulman  
 61787X Pub. Pr., \$29.95 Club Pr., \$17.50

**ANALOG SYSTEMS FOR MICROPROCESSORS AND MINICOMPUTERS** By P. M. Garrett  
 786496 Pub. Pr., \$18.95 Club Pr., \$14.95

**ENCYCLOPEDIA OF COMPUTER SCIENCE**  
 Edited by A. Reiston & C. L. Meek  
 76901X Pub. Pr., \$80.00 Club Pr., \$39.95

**MICROPROCESSOR AND MICROCOMPUTER SYSTEMS** By G. V. Rao  
 783659 Pub. Pr., \$24.50 Club Pr., \$18.50

**THE Z-80 MICROCOMPUTER HANDBOOK** By W. Barden, Jr.  
 784914 Pub. Pr., \$8.95 Club Pr., \$7.60

## Why YOU should join now!

- **BEST BOOKS IN YOUR FIELD**—Books are selected from a wide range of publishers by expert editors and consultants to give you continuing access to the latest books in your field.
- **BIG SAVINGS**—Build your library and save money too! We guarantee savings of at least 15% off publishers' list prices on every book. Usually 20%, 25% or even higher!
- **BONUS BOOKS**—You will immediately begin to participate in our Bonus Book Plan that allows you savings between 70-80% off the publisher's price of many books.
- **CONVENIENCE**—14 times a year you receive the Club Bulletin FREE, fully describing the Main Selection and alternate selections, together with a dated reply card. If you want the Main Selection, you simply do nothing—it will be shipped automatically. If you want an alternate selection—or no book at all—you simply indicate it on the regular reply card and return it by the date specified. You will have at least 10 days to decide. If, because of late mail delivery of the Bulletin you should receive a book you do not want, just return it at the Club's expense.

As a Club member, you agree only to the purchase of four books (including your first selection) over a two-year period.

**Computer Professionals' Book Club**  
 P.O. Box 582, Hightstown, New Jersey 08520

Please enroll me as a member and send me the two books indicated, billing me for my first selection only at the discounted member's price, plus local tax, postage and handling. If not satisfied, I may return the books within 10 days and my membership will be canceled. I agree to purchase a minimum of 3 additional books during the next 2 years as outlined under the club plan described in this ad. Membership in the club is continuous but cancellable by me any time after the four book purchase requirement has been fulfilled.

Write Code # of  
 FREE selection here

Write Code # of  
 FIRST selection here



Orders from outside the U.S. must be prepaid with international money orders in U.S. dollars.

Charge my  VISA  MASTER CHARGE\* Exp. Date \_\_\_\_\_

Credit Card # \_\_\_\_\_ \*MC Bank # \_\_\_\_\_

Signature \_\_\_\_\_

Name \_\_\_\_\_

Address \_\_\_\_\_

City, State, Zip \_\_\_\_\_

Corporate Affiliation \_\_\_\_\_

This order subject to acceptance by McGraw-Hill. All prices subject to change without notice. Offer good only to new members. A postage and handling charge is added to all shipments.

P39431

# hobby corner

*An easy-to-build circuit that monitors sound level and lets you know when it rises above or falls below a predetermined point, plus a nifty new solder station.*

EARL "DOC" SAVAGE, K4SDS, HOBBY EDITOR

THERE ARE TIMES WHEN ONE WISHES TO know when and if a sound level exceeds a certain point. It may be machinery that requires adjustment when its noise reaches a given level. It may be children (yours or the ones you babysit) who need to be reminded *automatically* when they get too noisy. Among other possibilities are your school or summer camp lunchroom or, even, your neighbor's stereo.

Of course, you could get an audio level meter, but have you priced one of those lately? And, besides, you have to watch the meter. Well, if all you want to know is when the level reaches a certain point, this simple project is what you have been looking for. As an added bonus, it can be set up to tell you if the noise falls *below* the setting—that is, if things get too quiet!

The heart of the loudness detector is a common 555 IC wired as a Schmitt trigger. As shown in Fig. 1, the output changes state—from high to low—when ever the input crosses a certain voltage. That threshold voltage is established by the setting of pot R4.

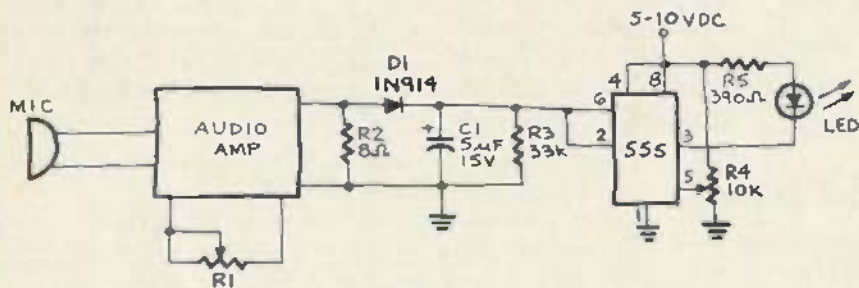

FIG. 1

The prototype circuit uses a LED in the output. As wired, it turns ON to indicate a higher voltage (noise). Obviously, if the LED and its associated resistor R5 were wired between pin 3 and ground, it would turn OFF to indicate that same condition.

The 555 control (input pins 2 and 6) voltage originates from a small audio amplifier. The amplifier output is fed to R2 which develops an AC voltage proportional to the sound level at the microphone. That voltage is rectified by D1 and filtered by C1 and R3. The gain of the

audio amplifier is controlled by potentiometer R1.

The amplitude of the voltage out of the filter is dependent upon the sound level. The greater the sound level, the greater the voltage.

When that voltage exceeds the threshold set by R4, the 555 output changes state and the LED turns ON. There you have it—a loudness detector! But a few details remain.

The audio amplifier can be whatever you happen to have on hand as long as it will output 150 mW or so. You may want to build a simple transistor or IC amplifier or you can use a commercial module. My loudness detector was first tested by running the output of a "shirt-pocket" radio across R2.

The LED can be replaced by a relay with a DC voltage rating appropriate to the supply voltage you apply to pin 8. The hook-up is shown in Fig. 2. Do not omit the diode. The back EMF from the relay is likely to ruin the 555. By using a relay, you can cause a bell to ring, a bright light to turn on or, even, the offending ma-

chine to cut off!

Use of the loudness detector requires proper setting of R1 (amplifier volume) and R4 (trigger threshold). I recommend that R4 be set to provide a reasonable range with the particular amplifier used. Then the sensitivity for different uses can be set on R1 alone. The control can then be calibrated in some arbitrary scale to permit resetting to a given level.

Of course, you can use the pots in the reverse manner but that will give you less latitude in sensitivity. However, the important thing is to have only one control

as the normally used variable—otherwise it will be difficult to reset the trigger level.

There are two other minor factors which you will discover as you use the detector. First, it is somewhat frequency sensitive. How much so depends partly on the microphone and amplifier used, but compensation is not worth the trouble except in critical applications.

Second, the detector displays hysteresis; that is, the cut-off level is lower than the cut-on level. You will find this to be an advantage in many uses. The actual

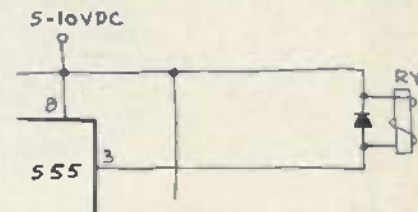

FIG. 2

difference between the two voltages varies with the setting of R4.

Certainly there are other uses to which you can put the basic 555 circuit. A variable voltage from any source will cause the light or other alarm to activate. All you have to do is to apply that voltage to pins 2 and 6 of the 555. Be sure, however, that the voltage on pins 2 and 6 does *not* exceed the applied voltage on pin 8 or the 555 will be damaged. In cases where this is a possibility, you should use a voltage divider or a Zener diode to prevent it.

## Please hold

I would like to pause to give a bit of gentle (?) advice to some advertisers of parts and equipment. It is very nice of you fellows to provide your telephone numbers, especially if you have a toll-free line.

You must know, however, that it is quite disconcerting to be placed on "hold" before the caller has a chance to say a word. It is *more* than disconcerting if the number is not toll-free and the caller is left paying to listen to a dead line.

Accordingly, I trust that all you good guys will review your procedures. If your establishment suffers from this malady, a correction will benefit both your customers *and you*. After all, other folks sell the same items.

A suggestion: if you can't handle it right then, don't answer it. We'll be glad to call back in a few minutes.

*continued on page 70*



# DIGITAL ACCURACY AT YOUR FINGERTIPS

## LX 303

by  
**HICKOK**



**ONLY  
74.<sup>95</sup>**

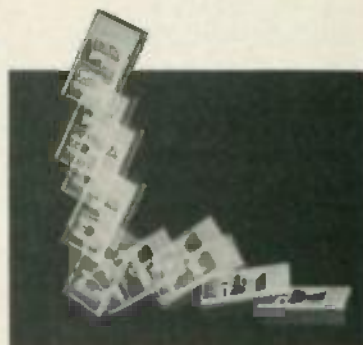
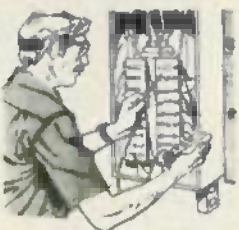

The LX303 is designed to withstand a drop from 4 feet without damage.

On the bench, in your hand or on-the-go, LX303 is your number one value in a compact DVOM. Even though it is low priced, the LX303 provides the level of performance you'd expect to find in more expensive instruments. A full 3 1/2 digit display (1.999 full-scale reading) provides range-to-range overlap for best accuracy and typical precision of better than 1%. The 100 mV DCV range gives you low level measurement capability usually found on instruments costing nearly twice the price. The maximum resolution of 0.1 ohms lets you accurately check ballast resistors, windings, coils, etc. The low-power output (0.35 V max. full-scale voltage) makes in-circuit resistance measurements sure and easy.

Fast, easy, one hand operation. Automatic polarity, automatic zero, automatic over-range indication and a rapid (3 per second) reading rate speed up and simplify operation. R. F. shielding assures you of jitter free

readings on the big, 1/2 inch high, easy reading, wide angle, LCD display. Panel switches are human engineered for easy one hand operation.

Years of hassle-free reliability. The 300 hour typical battery life means you'll only need to install a new battery once every 6 months or so (at 2 hours/day, 5 days/week). A convenient battery check capability is built in. The LX303's excellent overload characteristics also assure long reliable operation. All DC V ranges will take 1000 volts without damage except the 100 mV range which will handle 500 volts. All AC V ranges will withstand 600 volts. The ohms ranges are fully protected too - up to 120 volts AC or DC without damage - up to 240 volts short term.

Measure temperature for only \$39.95 more. Model TP-20 (F or C) Temperature probe measures from -67° to +302°F (TP-20F) or -55° to +150°C (TP-20C). Accuracy: ±2.7°F or ±1.5°C. Resolution: 0.1°. Operates 500 hrs. on a 9V battery.

Built to "take it". The high impact thermoplastic case and cover protect the LX303 from abuse in transportation and storage. Glass-epoxy pc board construction with a minimum of hand-wiring greatly reduces the possibility of field failures. Even the operating panel nomenclature is protected by a .010" thick layer of GE Lexan® to keep it clean and easily readable even after extended usage. LSI circuitry and a laser-trimmed thick film resistor network provide a very low parts count inside, so there's less to go wrong in a variety of temperatures, climates and working situations. All plugs and jacks are recessed and all metal parts fully insulated for your safety even in hand-held usage.

Order with confidence. Thousands of these units are already in use by engineers and technicians from many of the largest U.S. corporations. LX303 is manufactured in the U.S.A. and carries a full one year warranty from the Hickok Electrical Instrument Company with over 65 years of test equipment production experience. Your LX303 comes to you fully assembled and calibrated, complete with test leads and instruction manual.

As one of Hickok's leading national distributors we unconditionally recommend the LX303 as an outstanding value. Use this coupon or phone to place your order directly to us.

**PRIORITY ONE  
ELECTRONICS**

16723 Roscoe Blvd. Sepulveda, CA 91343

### LX 303 SPECIFICATIONS

DC Volts (5 RANGES): 200mV to 1000V full scale. RESOLUTION 0.1mV. ACCURACY: ±(0.5% rdg + 0.5% f.s.); INPUT IMPEDANCE: 10MΩ; OVERLOAD PROTECTION, 1000VDC or peak AC all ranges. AC VOLTS (40 Hz to 5kHz): 200V to 600V full scale; RESOLUTION: 0.1V; ACCURACY: ±(1.0% rdg - 0.5% f.s.); 20 db at 5kHz; OVERLOAD PROTECTION: 600VDC or rms. RESISTANCE (6 RANGES, LOW POWER): 200Ω to 20MΩ full scale; RESOLUTION: 0.1Ω; ACCURACY: ±(0.5% rdg + 0.5% f.s.) ±(1.5% rdg + 0.5% f.s.) on 20MΩ range; OVERLOAD PROTECTION: 120VDC or rms all ranges, 240V rms for 30 sec. DC CURRENT (8 RANGES): 20 nA to 200 mA full scale. ACCURACY: ±(0.5% rdg + 0.5% f.s.); OVERLOAD PROTECTION: 80V on 10nA to 10 μA ranges, 25 mA on 100 μA range and 500 mA on 100 mA range. GENERAL DIMENSIONS: 5 1/2" x 3 1/4" x 1 1/2" (14.7 x 8.5 x 4.3cm); WEIGHT: 12 oz (0.33kg). POWER 9V battery (not incl.) or HICKOK AC Adapter; BATTERY LIFE: Alkaline, 300 hours typical READ RATE: 3/sec.; TEMPERATURE: 0 C to 50 C operating, -35 C to +60 C storage.

**PRIORITY ONE ELECTRONICS**

TO ORDER CALL TOLL FREE  
800-423-5833

16723 Roscoe Blvd., Sepulveda, CA 91343 213-894-8171

PLEASE SEND ME

\_\_\_\_\_ Hickok LX303 Digital Multimeters ..... @ 74.95 ea.  
 \_\_\_\_\_ RC-3 AC Adapter, 115VAC (220VAC avail.) ..... @ 8.00 ea.  
 \_\_\_\_\_ CC-3 Deluxe Carrying Case ..... @ 8.00 ea.  
 \_\_\_\_\_ YP-10 x 10 DCV Probe Adapter ..... @ 16.50 ea.  
 \_\_\_\_\_ CS-1 10A DC Current Shunt ..... @ 16.50 ea.  
 \_\_\_\_\_ TP-20 Temperature Probe (specify C or F) ..... @ 39.95 ea.

Payment encl.  Bill my: Master Charge  VISA

Account # \_\_\_\_\_ Exp. Date \_\_\_\_\_

Name \_\_\_\_\_

Address \_\_\_\_\_

City \_\_\_\_\_ State \_\_\_\_\_ Zip \_\_\_\_\_

Add \$3.00 Postage and Handling. CA residents add sales tax.

CIRCLE 55 ON FREE INFORMATION CARD

JANUARY 1980 69

# ONLY \$650. UNBELIEVABLE!

Introducing the Schober Automatic Electronic Organ. Two keyboards. 27 push-buttons. Four rotary controls. Three chord pedals. Eight rhythm patterns. An Incredible 60 automatic chords. Plus more automatic features and ways to combine them for greater musical versatility than any instrument of its type. You build it yourself from our complete kit. So simple, anyone can do it.



The Schober Organ Corp. Dept. RE-89  
43 West 61st Street, New York, N.Y. 10023

**Schober**

To order enclose  Check  Money Order for \$650 (N.Y. residents please add tax. Shipping charges C.O.D.) or charge to:  
 Master Charge  Visa Acct. # \_\_\_\_\_  
Interbank # \_\_\_\_\_ Expiration Date \_\_\_\_\_  
Or call (212) 586-7552 to order.

Name \_\_\_\_\_  
Address \_\_\_\_\_  
City \_\_\_\_\_ State \_\_\_\_\_ Zip \_\_\_\_\_  
For additional free information

CIRCLE 2 ON FREE INFORMATION CARD

## HOBBY CORNER continued from page 68

### Solder station

PanaVise (2850 29th St., Long Beach, CA 90806) has come out with a neat and effective solder station. It consists of a holder for spools of solder and/or wire and a holder for your iron. Also provided are two sponge tip cleaners. The holders can be used separately or fastened together (bolts provided) as a single unit for either right or left hand use. (See Fig. 3)

The station can be mounted on your workbench, on the wall, or you can put it on a movable base. One or both holders, separately or as a unit, also may be mounted on PanaVise's holders for boards/parts (and you already know how great I think they are).

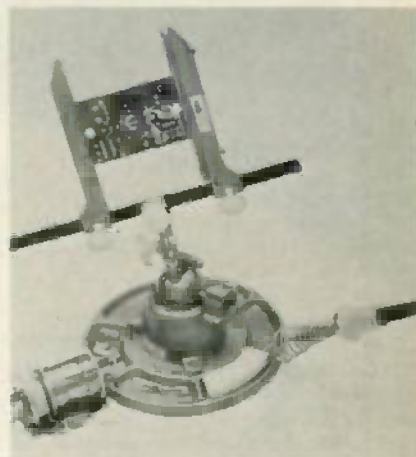

FIG. 3

If you aren't using a solder station, consider the convenience of having an iron, solder, and wire right where you need them. You may not be as careless as I, but it is good to have a place to put your iron so it isn't lying around waiting to burn your hand! The model 371 solder station sells for about \$5. R-E

*Vector*

## KLIP-BLOKS

**NO SOLDERING**  
...Just Push In

- DIPS, transistors, components patch with ordinary wire
- Buy only sockets needed and — save money!
- Exclusive thru-holes open top and bottom give greater component density. 4 connected contacts per strip with 1 to 24 strips per block — all on .1" grid. FAST! EASY!

Available From Vector Distributors or Factory

Vector ELECTRONIC COMPANY, INC. 12460 E. Gladstone Ave. Sylmar, Calif. 91342 (213) 365 9661 TWX (910) 496 1539

Patented

0.015" 0.032" leads

T45-4 Single "Quad"

T45-4 Klip-Strip Bus

T66-32 8 Quad Klip-Blok

T66-36 24 Quad Klip-Blok

3511-C-888

Klip-Bloks snap on Tenth-Tenth Micro-Vectorbord

CIRCLE 41 ON FREE INFORMATION CARD



"Next time you check resistance ranges around here, leave me out of it!"

**CONFERENCE CALLER**  
continued from page 49



INTERIOR VIEW OF the Conference Caller. The two non-polarized isolating capacitors are wired directly to the switch.

**Construction and installation**

Construction is simple and wiring is not at all critical. The components can be mounted directly to the switch. When you connect the conference caller to your telephone lines make sure only the green wires go to the green terminals, and the red wires to the red terminals.

C1 and C2 must be nonpolar (not electrolytic) capacitors rated at more than 100 volts. If you want to expand your conference caller to use three or more telephones, simply add two more capacitors and a switch for each additional line (see the dashed box in Fig. 1).

To test this device, have a friend call one of the numbers connected to it. Next, call someone else, using the other phone. Now, close the switch and all three of you should be able to talk together.

-R-E



**Featuring RCA 1802 COSMAC CPU**

Own a powerful home computer system starting for just \$99.95—a price that gets you up and running the very first night with your own TV for a video display. 179.95 ELF II includes RCA 1802 8 bit microprocessor addressable to 64K bytes with DMA interrupt. It registers 16K 256 bytes RAM, full size keyboard, two digit hex output display, stable crystal clock for timing purposes. RCA 1801 video IC to display your programs on any video monitor or TV screen and 1 foot plug in expansion bus type connectors to expand ELF II into a giant!

**ELF II Explodes Into A Giant!**

Master ELF II's 179.95 capabilities, then expand with GIANT BOARD KLUGE BOARD 4x RAM BOARDS TRAY BASIC ASCII KEYBOARD LIGHT PEN ELF BUG MONITOR COLOR GRAPHICS & MUSIC SYSTEM TEXT EDITOR ASSEMBLER DISASSEMBLER VIDEO DISPLAY BOARD and, another great reason for getting your ELF now—

**BREAKTHROUGH!**

Netronics Proudly announced the release of the first 1802 FULL BASIC, written by L. Sandlin, with a hardware floating Point RPM math package (requires 8K RAM plus ASCII and video display boards). \$79.95 plus \$2 p&h. Also available for RCA VIP and other 1802 systems (send for details!)

**Master This Computer In A Flash!**

Regardless of how detailed your computer background is, you can learn to program an ELF II in almost no time at all. Our Short Course On Microprocessors & Computer Programming, written in 100% machine language, guides you through each of the RCA COSMAC 1802's capabilities so you'll understand everything ELF II can do... and how to get ELF II to do it! Don't worry if you've been stumped by computer books before. The Short Course represents a major advance in literary clarity in the computer field. You don't have to be a computer engineer in order to understand it. Read it ELF II, it's loaded with "handy do" illustrations. When you're finished with the Short Course, neither ELF II nor the RCA 1802 will hold any mysteries for you.

In 1982, not only will you now be able to own a personal computer creatively, you'll also be able to read magazines such as BYTE, INTRINSIC, A&E, POPULAR ELECTRONICS and PERSONAL COMPUTING and fully understand the articles. And, you'll understand how to expand ELF II to give you the exact capabilities you need!

If you work with large computers, ELF II and the Short Course will help you understand what they're doing.

**Get Started For Just \$99.95, Complete!**

179.95 ELF II includes all the hardware and software you need to start writing and running programs at home, displaying video graphics on your TV screen and designing circuits using a microprocessor—the way the very first night, even if you've never used a computer before.

ELF II connects directly to the video input of your TV set, without any additional hardware. Or, with an 14.95 RF module (see coupon below), you can connect ELF II to your TV's antenna terminals instead.

ELF II has been designed to play all the video games you want, including a fascinating new tetra-minis game that was developed specifically for ELF II. But games are only the icing on the cake. The real value of ELF II is that it gives you a chance to write machine language programs—and machine language is the fundamental language of all computers. Of course, machine language is only a starting point. You can also program ELF II with assembly language and TRAY BASIC. But ELF II's machine language capability gives you a chance to develop a working knowledge of computers that you can't get from reading only.

**Write and run programs—the very first night—even if you've never used a computer before!**

You're up and running with video graphics for just \$99.95 — then use low cost add-ons to create your own Personal System that rivals home computers sold for 5-times ELF II's low price!

pre-recorded tape cassettes.

**ELF II Gives You The Power To Make Things Happen!**

Expanded ELF II can give you more power to make things happen in the real world than hardly re-ordained home computers that sell for a lot more money. Thanks to an ongoing commitment to provide the RCA 1802 for home computer use, the ELF II products—being introduced by Netronics—keep you right on the outer fringe of today's small computer technology. It's a perfect computer for engineering business, industrial scientific and personal applications.

Plug in the GIANT BOARD to record and play back programs, edit and debug programs, communicate with remote devices and make things happen in the outside world. Add Kluge for step-by-step Board and you can use ELF II to solve special problems such as stepping a camera, alarm system or controlling a printing press. Add 4x RAM Boards to create longer programs, store more information and solve more sophisticated problems.

ELF II add-on units include the ELF II Light Pen and the amazing ELF BUG Monitor (see extremely recent brochure) that have not yet been duplicated by any other manufacturer.

The ELF BUG Monitor lets you debug programs with lightning speed because the key to debugging is to know exactly inside the registers of the microprocessor. And, with the ELF BUG Monitor, instead of single stepping through your programs, you can now display the entire contents of the registers on your TV screen. The find out immediately what's going on and can make any necessary changes.

The incredible ELF II Light Pen lets you draw anything you want on a TV screen with just a wave of the "magic wand." Netronics has also introduced the ELF II Color Graphics & Music System—more breakthroughs that ELF II owners were the first to enjoy!

**ELF II Tiny BASIC**

Ultimately, ELF II understands only machine language—the fundamental coding required by all computers. But, to simplify your relationship with ELF II, we've introduced an ELF II Tiny BASIC that makes communicating with ELF II a breeze.

**Now Available! Text Editor, Assembler, Disassembler And A New Video Display Board!**

The Text Editor gives you word processing ability, and the ability to edit programs as text while it is displayed on your video monitor. Lines and characters may be quickly inserted, deleted or changed. Add a printer and ELF II can type letters for you—error free—plus print names and addresses from your mailing list!

ELF II's Assembler translates assembly language programs into hexadecimal machine code for ELF II. This Assembler features mnemonic abbreviations, inserts blank numbers to show the instructions of your programs are easier to read—this is a big help in catching errors.

ELF II's Disassembler takes machine code programs and produces assembly language source listings. This helps you understand the programs you are working with—and improve them when required.

The new ELF II Video Display Board lets you generate a sharp, professional 37 or 64 character by 16 line upper and lower case display on your TV screen or video monitor—dramatically improving your expanded 179.95 ELF II. When you get into longer programs, the Video Display Board is a real blessing!

**Now Available!**

- A-D/D-A Board Kit includes 1 channel (expandable to 4) D-A, A-D converters. \$39.95 plus \$2 postage & handling.
- PILOT Language—A new text-oriented language that allows you to write educational programs on ELF II with speed and ease! Write programs for games... unscrambling sentences... spelling drills... "fill in the missing word" tests, etc! PILOT is a must for any ELF II owner with children. PILOT Language on cassette tape, only \$19.95 postpaid!
- Game Pack on cassette tape (requires 4K RAM), \$9.95 plus \$2 postage & handling.

Clip Here and Attach to Your Order Below!

**PHONE ORDERS ACCEPTED!**  
Call (203) 354-9375

**Radio-Electronics®**  
is available in  
**MICROFILM**  
UNIVERSITY MICROFILMS  
300 N. Zeeb Road  
Ann Arbor, Michigan 48106  
and  
**MICROFICHE**

**MICROCARD EDITIONS**  
A Division of  
Information Handling Services  
P.O. Box 1154  
Englewood, Colorado 80110

**BELL & HOWELL CO.**  
Micro Photo Division  
Old Mansfield Road  
Waco, Ohio 44891  
Attn.: Mr. Spiers

Please write for complete information

**Netronics R&D Ltd., Dept RE-1**  
333 Litchfield Road, New Milford, CT 06776

Yes! I want my own computer! Please rush me—

<input type="checkbox"/> RCA COSMAC ELF II kit at \$99.95 plus \$3 postage and handling (requires a 3 or 6 volt AC power source)	<input type="checkbox"/> Language II's a starting breakthrough for engineers and system designers. \$59.95 plus \$2.50 p&h
<input type="checkbox"/> RCA 1802 User's Manual \$5 postpaid	<input type="checkbox"/> Deluxe Metal Cabinet with strength dust cover for ELF II \$29.95 plus \$2.50 p&h
<input type="checkbox"/> Tom Prideman's Short Course On Microprocessors & Computer Programming teaches you and about the thing there is in it about ELF II—on only RCA 1802 computer. Written in non-technical language.	<input type="checkbox"/> I am and enclosing payment (including postage & handling) for my items checked below.
<input type="checkbox"/> I want my ELF II used and tested with power supply. RCA 1802 User's Manual and Short Course—at \$149.95 plus \$3 p&h	

**ALSO AVAILABLE FOR ELF II**

<input type="checkbox"/> GIANT BOARD—4x with cassette I/O. RS 232 C 115.170 or 310 bauds for 14 separate I/O registers and a system monitor register. \$39.95 plus \$2 p&h	<input type="checkbox"/> 25 varieties A-Z ELF II FINELY EDITED: GD 10 GD 1500 RE LIGHT EDIT. RE CLEAR. 1051 TRAY PILOT PILOT. PILOT. Combs fully documented, and outputs alphanumeric characters directly on your screen with all additional hardware. Also puts its back to 1802's drawing game that uses ELF II's hex keyboard as a play area. 4x memory required. \$14.95 postpaid.
<input type="checkbox"/> Kluge (Photo) Board accepts up to 16 IC's \$17.95 plus \$2 p&h	<input type="checkbox"/> Tom Prideman's Short Course on Tray Basic for ELF II \$8 postpaid
<input type="checkbox"/> 4x Static RAM bit Addressable 16 bit 4x 16K to 64K \$41.95 plus \$3 p&h	<input type="checkbox"/> ELF-BUG™ Deluxe System Monitor on cassette tape. Assists displaying the contents of all registers on your TV at any point in your program. Also displays 24 bytes of memory with full addresses, banking cursor and auto scrolling. A must for the serious programmer! \$14.95 postpaid.
<input type="checkbox"/> Gold plated 86-pin connectors (one required for each plug-in board) \$5.75 ea. postpaid	<input type="checkbox"/> Text Editor on cassette tape gives you the ability to insert, delete or edit lines and words from your programs while they are displayed on your video monitor. Lined printer and you can use ELF II to type or edit letters. Also inserts names and addresses from your mailing list. \$19.95 postpaid.
<input type="checkbox"/> Expansion Power Supply \$10.00 when adding 4x Kluge. \$24.95 plus \$2 p&h	<input type="checkbox"/> I can edit on cassette tape gives you the ability to insert, delete or edit lines and words from your programs while they are displayed on your video monitor. Lined printer and you can use ELF II to type or edit letters. Also inserts names and addresses from your mailing list. \$19.95 postpaid.
<input type="checkbox"/> Professional ASCII keyboard 4x with 178 ASCII upper/lower case key set, 96 character characters, standard register, parity, stop selection and check of hand, using 16 pins to mate with almost any computer. \$44.95 plus \$2 p&h	<input type="checkbox"/> Assembler on cassette tape translates assembly language programs into hexadecimal machine code for ELF II. Uses mnemonic abbreviations for instructions (rather than numbers) make programs easier to read and help prevent errors. \$19.95 postpaid.
<input type="checkbox"/> Deluxe metal cabinet for ASCII keyboard \$19.95 plus \$2.50 p&h	<input type="checkbox"/> Disassembler on cassette tape takes machine code
<input type="checkbox"/> Video Display Board—4x lets you generate a sharp professional 37 or 64 character by 16 line upper and lower case display on your TV screen or video monitor—dramatically improving your expanded \$99.95 ELF II. (4x static RAM keyboard cabinet \$149.95 plus \$2 p&h)	

ELF II Tiny BASIC on cassette tape. Combs includes SAVE LOAD. \$14.95 postpaid.

programs and produces assembly language source listings to help you understand and improve your programs. \$19.95 on cassette tape.

**SAVE 15.00!** Text Editor, Assembler & Disassembler packaged together only \$41.95! Requires Video Display Board plus 4 pins to memory!

ELF II Light Pen Assembler & Editor \$7.95 plus \$1 p&h

ELF II Color Graphics & Music System Board kit \$49.95 plus \$2 p&h

ELF II connects directly to the video input of your TV set without additional hardware. To connect ELF II to your antenna terminals, include order RF Module \$8.95 postpaid.

Coming Soon: A-D & Converter, Controller Board and more!

Price Name Address City State Zip

Account # \_\_\_\_\_

Total Enclosed \$ \_\_\_\_\_ (Cash reg. add tax)

CHARGE IT! Exp. Date \_\_\_\_\_

Visa  MasterCard (Bank # \_\_\_\_\_)

Account # \_\_\_\_\_

Circle 26 on FREE INFORMATION CARD

# communications corner

*A phonograph record that tells all about shortwave listening, plus a tri-band monitor antenna.*

HERB FRIEDMAN, COMMUNICATIONS EDITOR

THE CHINESE PHILOSOPHER CONFUCIUS once said: "A picture is worth a thousand words." Had he lived in our time he might have added: "... but one good LP recording is worth all the words and all the pictures."

For more than a quarter century I have been reading about one of my favorite hobbies, shortwave listening—or SWL'ing as it is more commonly known—and in all that time I have yet to find a book on the subject that was not deadly dull. One of the problems with modern books is that a publisher usually contracts for a specific length. The writer has to fill so many pages; and an exciting subject, such as SWL'ing, can easily get buried in excess verbiage, sure to put one to sleep by the twentieth page. (It takes five pages just to thank all those who helped the author.)

If you'd like to get the real flavor of SWL'ing, or if there's some youngster who you think would enjoy getting into it, the pathway to this little known but widely practiced hobby is through a 12-inch LP record that goes by the rather insipid title of *Long Live Shortwave!* (exclamation mark and all). Put together and narrated by Mitch Murray, one of Great Britain's leading songwriters, who is also an avid SWL (Short-Wave Listener), the record is an obvious labor of love. (See Fig. 1.) Side A tells us about SWL'ing; what it is, the frequencies in use during different time periods, antenna tips... just about everything a new SWL would want to know. For example, there are actual samples of the sounds of RTTY, SSTV and satellite signals.

There isn't a wasted word on the whole side, which runs about 22 minutes. One subject flows into the next, and the youngsters—and a few old-timers—we played the record for were left sitting on the edges of their seats waiting to hear what Mitch would cover next.

A small booklet, actually a piece of paper about 8 × 13 inches that is folded in thirds, contains the artwork that Mitch refers to. Some of the pictures are antenna designs; others are charts, such as the SINPO code and frequency conversion. (SINPO is a method of reporting reception quality—*Editor*)

On that one side of an LP, Mitch Mur-



FIG. 1

ray covers SWL'ing better than does any book I've read.

The flip side of the record is still more fun. It contains the station identification, or *signatures*, of SW stations around the globe: from the "Blue Danube" cimbalon signature of Austrian Radio to some exotic bird of New Zealand. You can tell who is broadcasting, even if you don't know the language, by these "signatures."

One really big extra provided with the record is a listing of the major DX clubs around the world, including addresses. In many instances those are "umbrella" clubs that can supply you with the address of any DX club that is in your local area.

*Long Live Shortwave!* is available from Trans-Island Productions Ltd., P.O. Box 24, Douglas, Isle of Man, British Isles, for \$6.95 including postage. Specify either record or cassette format.

## Raising the antenna current

As to mobile CB antennas, there are two "rules" that determine how far your signal travels: 1—For a given antenna design (base-loaded, center-loaded, etc.), the longer the overall antenna length, the greater the radiation. 2—For a given antenna length, the higher the loading coil (if any), the greater the radiated signal. Since each antenna type has its advantages and disadvantages you usually select the best compromise for your own personal needs. However, if you're presently using certain base-loaded mobile antennas and would like to switch to one of the continuously-loaded, or top-loaded designs, you can do so without going through the expense of a complete antenna system. A small metal gadget from Anixter-Mark, the model HWA-1 CB Antenna Adapter, screws on in place of some base-loading coils and provides a standard 1/4 inch-24 thread for standard and loaded whips, quick-connectors, and light-duty springs.

Presently, the model HWA-1 can be used on the following antenna mounts: A/S model M-125; Royce model 2-205; Antenna Inc. model 17610, and a host of imported models. Your best bet is to go down to your local Anixter-Mark antenna dealer and make sure the adaptor will fit your mount.

The primary advantage of using an antenna with a high loading coil is shown in Fig. 2. Note that radiation is from the area of maximum current, which is near the base of the antenna. The closer the loading coil is to the base the more the radiating current area gets *squished* towards the groundplane. Maximum current—hence, maximum radiation—for a given antenna length is provided by top loading; but top loading gets very "hairy." It has a narrow bandwidth and

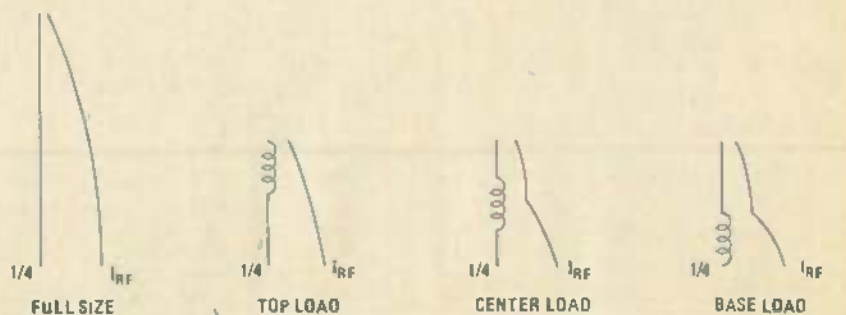

PHYSICALLY SHORTENED ANTENNAS

FIG. 2

requires really precise tuning for lowest SWR. Nontuneable models positively require a broad groundplane under them, such as the roof of a car or RV, or the center of a trunk.

**Tri-band monitor antenna.**

Our final item this time falls into the "Why didn't I think of it?" category. It's the magnetic mounted mobile low/high VHF and UHF monitor antenna, Hustler model MOM, covering the 30-50, 150-174, and 450-512 MHz bands. Basically, it consists of a magnetic mount with an antenna approximately 34 inches long. The whip antenna has a loading coil in the approximate center that "tunes" the whip to the low (30-50) VHF band. On the high VHF band the coil functions as an "isolator," or trap, so signals are received by the lower part of the antenna that functions as a 1/4-wave whip at the high-VHF frequencies. On the UHF band the lower part of the antenna appears to function as a 1/4-wave whip. (The sizes are only approximate. The antenna is for receiving only; not for transmitting.)

The supplied 17-foot coax cable has Motorola-type plugs on both ends since it plugs into a matching connector on the magnetic base.

Why a plug-in connector? That is where the "Why didn't I think of it?" comes in. The magnetic base has two slots cut in the rear. A small metal bracket supplied with the antenna is attached to the edge of the trunk lip behind the rear window. The bracket is similar to those used for "standard" trunk-lip antennas except for two small hooks that protrude upward. If you intend to barrel down the highway at speeds that might tear a magnetic mount loose (and contrary to what anyone says it *does* happen), you simply engage the slots in the mount with the hooks when you install the antenna and it will stay put under any driving condition. Between the hooks and the magnets that antenna doesn't come loose.

To remove the antenna you simply unplug the coax at the mount and lift the antenna off the hooks. A weatherproof cap is provided for the coax plug in case you want to leave it out for possible instant use.

One other bit about the Hustler MOM: It makes a great "indoor" VHF/UHF antenna if your monitoradio has a metal cabinet. Simply place it on top of the cabinet; the magnet locks it in place. R-E

The baby we save could be yours.

**United Cerebral Palsy** 

# In An Instant. YOU CAN SAFELY PLUG AWAY WITHOUT OVERLOADING OR COMING UP SHORT

You can do it thanks to SGL WABER® multiple outlet strips. There are over 250 versatile models with unsurpassed quality workmanship. Each exceeds National Electrical Code standards and is safety tested. Ideal for organizing your work area and having extra outlets *exactly* where you want them. Over 2,000 electronic distributors carry the SGL Waber line. Send for our free 24-page catalog, today!

**SGL WABER Electric**  
A division of SGL Industries, Inc.  
Dept. H—300 Harvard Avenue  
Westville, New Jersey 08093  
(609) 456-5400



CIRCLE 16 ON FREE INFORMATION CARD

## BUILD A MASTERPIECE OF SOUND



percussion and sustain. Wersi's famous string orchestra and bass guitar. Exclusive Sound Computer for 32-128 "One Stop Sounds" (total organ presets). Transposer. And lots more.

Build your own masterpiece of sound. No technical knowledge required. Just follow the clearly illustrated, easy-to-understand instructions. Step by step. Choose from at least 10 models. (Also factory assembled.)

Send \$6.00 with coupon for your Wersi Demo-Package (LP with 104-page color catalog).

 **WERSI**

Wersi has combined select features of the electronic music field, added its own creations and years of research by top engineers and musicians, to produce an incomparable line of organs.

Space-age technology. True-to-life voicing with full drawbar system. Polyphonic

RE 100

Wersi Electronics, Inc. or Wersi Organs & Kits  
1720 Hempstead Road 14104 E. Firestone Blvd  
Lancaster, PA 17601 Santa Fe Springs, CA 90670

Enclosed is \$6.00 for my Demo-Package (LP with 104-page color catalog.)

Name \_\_\_\_\_  
Address \_\_\_\_\_  
City \_\_\_\_\_ State \_\_\_\_\_ Zip \_\_\_\_\_

CIRCLE 21 ON FREE INFORMATION CARD

JANUARY 1968

# service clinic

## The "Christmas tree" pattern reveals itself once again.

JACK DARR, SERVICE EDITOR

A LONG TIME AGO, THERE WERE MANY TV sets. These were black-and-white sets, and they all had their problems (You'll note that this tendency is still around!) One of the most annoying of these was a peculiar instability in the horizontal oscillator. Because of the unmistakable pattern it made on the TV screen, it was easy to recognize, but could be very hard to find. That is the "Christmas tree" (Fig. 1) and is one of the places where the "big scope" (TV screen) actually gave you the diagnosis!



FIG. 1

Analyzing this, you can see that the horizontal oscillator starts to sweep only a wee bit, and slowly, at the top of the screen. Gradually, this gets wider and wider. When the trace gets to the bottom of the screen, it abruptly collapses and the whole sequence starts over again. The horizontal oscillator is *trying* to work. When it reaches a certain amplitude, it collapses. The reason is that something is upsetting the *feedback*. No feedback means no oscillation, in any kind of oscillator circuit.

The major cause of this is something is getting into the normal feedback loop of the oscillator, and preventing it from going into normal oscillation. Probably caused by cancellation of pulses, etc. Eventually, we found that the main cause of this was a bad filter capacitor, usually in the B+ line that fed both horizontal oscillator and horizontal output stage. Pulses were being fed back through the B+, and got to the wrong place at exactly the right time, to kill the oscillation. Incidentally, you'll notice that there is also a 60-Hz ripple involved in this! The tree pattern is steady! So, the oscillator is being gradually "killed" at a 60-Hz rate. A capacitor allows increase in this ripple and lets 15.750 Hz. pulses in.

The exception to this rule is in sets with the popular *Synchroguide* oscillator circuit. By carefully setting this up exactly *wrong*, you could find a combination of adjustments to the two coils that would let it Christmas tree.

With later model sets, we haven't seen the Christmas tree pattern for a long time. The other day, I saw one! Real dandy, too. Same unmistakable pattern, but a double; there were two trees, top to bottom, complete in every detail. (Fig. 2) This was in a Sylvania E06-02 chassis. Original complaint was loss of height. Replacing the vertical driver/amplifier IC cleared this up, and the set went home. Back in a few days, with complaint of "lines in the picture and makes funny noise at turn-on". On the bench, it played very well for quite a while.



FIG. 2

Finally, it began to show horizontal pulling at a 2-3 second rate, then went into the new Christmas tree pattern. From force of habit, I scope the B+ line feeding the horizontal oscillator! The scope showed pulses here. DC Voltage readings were low, and the B+ boost line, +170 V was also low and showed pulses. A bad filter was suspected. Turned out to be a 100  $\mu$ F 250 V capacitor on the +170 V boost line. This is a flyback-derived voltage and could be expected to be low with the odd drive waveform from the oscillator. However, it was the culprit; the open filter was allowing high pulse voltages to develop on the +170 V line, and this was managing to get into the B+ line feeding the horizontal oscillator, in amplitude great enough to cause the incorrect feedback and Christmas tree pattern. However, the old concept seems to be valid still; the major cause was a bad filter capacitor and the proof of the pudding was the presence of pulses on the

B+ lines. Replacing this capacitor cleared up the problem.

So: if you start seeing Christmas trees in the middle of the summer, up scope and look first on your B+ lines feeding the horizontal oscillator. As far as I know, it is not possible for a normally-operating horizontal oscillator of the modern type to be misadjusted in such a way that it will Christmas tree. In the *Synchroguides*, the two coils made it fairly easy to find a setting that would cause this. Some used to call this "squegging". A fascinating word, and I've never yet been able to find out where it came from or what it meant! Sounds like one that was invented to describe something, and in that way, I guess it's OK! R-E

## service questions

### HORIZONTAL PROBLEM

*I have a problem with a model 1872 XAM color set. It came in with sound and no raster. I changed the output, the high-voltage rectifier and the damper. The picture came back, but now it runs horizontally. Adjusting the hold control finally produced three pictures side by side, vertically locked. I've checked everything I can think of. Any ideas? I used a solid-state high-voltage rectifier. Could this be causing it?—J.G., Brooklyn, NY.*

This is a horizontal-frequency problem, and I doubt that the high-voltage rectifier would affect it at all. Try this to see if it works: Shunt out the horizontal AFC and see if you can adjust the horizontal-hold control, etc., to get ONE straight-sided floating picture.

If you can't, then there's a part off-tolerance somewhere in the frequency-determining section of the oscillator—either the coil or the capacitors across it. Check C261, C262 and the resistance of the coil, both sides of the tap. Be sure to use exact replacements for these parts; they are critical.

### VERTICAL SHRINK, POOR SYNC

Here's one that fooled me for a while. The picture on this GE KC chassis shrank up from the bottom, and had very poor vertical sync. After checking a few things with no luck, I finally pulled the deflection yoke and found that the little thermistor in series with the bottom half

Put Professional Knowledge and a  
**COLLEGE DEGREE**  
In your Electronics Career through  
**HOME STUDY**

**Earn Your DEGREE**

No commuting to class. Study at your own pace, while continuing your present job. The Grantham home-study program leads first to the A.S.E.T. and then to the B.S.E.T. degree. Our free bulletin gives complete details. Write for *Bulletin 80*.

**Grantham College of Engineering**  
2500 So. LaCienega Blvd.  
Los Angeles, California 90034

**GRANTHAM'S FCC LICENSE STUDY GUIDE**  
—377 pages, 16 FCC-type practice tests, 1465 questions with answers and discussions—covering third, second, and first class radiotelephone license exams. Preparation for each separate class of license is presented in a separate section of the book. \$14.75 postpaid. Order from: GSE Publications, P.O. Box 35499, Los Angeles, Ca. 90035

**Cramped for Antenna space?**



**The MCKAY DYMEK DA 100.**

The DA 100 is a compact, wide dynamic range, broadband, unfused, omni-directional receiving antenna covering the frequency range of 50 kHz to 30 MHz. The exterior module, a small weather-proof box with a 56 inch (142 cm) whip delivers the signal to the power supply unit through a supplied 50' coaxial cable. The power supply locates near your general coverage receiver and attaches with a supplied patch cord. The DA 100 antenna is small, but will equal or outperform a 100' long wire antenna, and is priced within reach of everyone! **Output Impedance - Attenuator Switch** provided to match receiver input requirements and prevent overload.

Order factory Direct. Call toll free today! Money Back guarantee. Rent/Own Plan available. Specs and details on request.

Nationwide 800/854-7769  
California 800/472-1783  
**MK** McKay Dymek Co.  
111 S. College Ave., PO Box 5000  
Claremont CA 91711

CIRCLE 39 ON FREE INFORMATION CARD

of the yoke was bad. Apparently this also caused the sync problem. Please pass this along.

Sure will, and thanks to Bob Stevens, TV Rebuild Service, for this tip.

**MAGNAVOX HEAD NEEDED**

*I need a play-record head for a Magnavox model 2TR200S reel-to-reel tape recorder. The factory says it's not available any more. Do you have any information on this?—L.T., Wartburg, TN.*

The Nortronics Company (8101 Tenth Ave. North, Minneapolis, MN 55427) does list this Magnavox part number. They list their type 1002 as a replacement for the Magnavox 76149043 head. I hope this helps.

**BRIGHTNESS PROBLEM**

Don Black, service manager for Sony of Canada, Ltd., sends along this note about the raster shading problem in the Sony model KV-1910 mentioned in the January 1979 issue. He says that it is apt to be caused by filter capacitor C707, (4.7  $\mu$ F, 250V) on board T. This is a filter in the collector supply circuit to the R-G-B output transistors. Thanks to Mr. Black for his help.

**BAD FLYBACK**

*I'm a teacher's aid in a vocational school radio-TV repair class. We have a problem with an RCA model KCS-153B. The high voltage is very low; there is severe blooming and not enough width. I found that the high-voltage winding of the flyback read 15,000 ohms. (The diagram shows this should read 590 ohms.) The transformer shows continuity, but also shows "short." Do you think this flyback is bad?—L.L., LaGrange, KY.*

Yes. It has probably overheated and shorted a few turns in the high-voltage winding. This will cause all of the symptoms you describe.

**SCOPE POSITIONING PROBLEM**

Your crystal ball hit it right on the nose in a horizontal positioning problem in my Sylvania model 400 scope. The voltages on the 7C5's were the same, but on the horizontal internal/external switch, one voltage was OK and the other way up. The 0.1- $\mu$ F coupling capacitor, C37, was shorted! I replaced C37 with a new capacitor and bingo! Thanks.—Roger Williams, New Orleans, LA.

**HIGH-VOLTAGE PROBLEM**

*This Admiral model 3K19 is showing several odd symptoms. The cathode current in the 26LW6 is way up, and the high voltage is way down. The boost voltage is just about right at 875 volts. Any ideas you might have would be welcome.—J.C., Berlin, NY.*

I have one idea: If your boost voltage is normal, this tells you that the horizontal-output stage, deflection yoke and flyback  
*continued on page 76*

**FREE**

The newest in home computers, fine stereo components, color TV, HAM radio, precision test equipment, innovative electronics for the home—all in easy-to-build, money-saving kits.

Send today for your **FREE Heathkit Catalog**



If coupon is missing, write Heath Co., Dept. 020-612, Benton Harbor, MI 49022

Send to: Heath Co., Dept. 020-612, Benton Harbor, MI 49022.

Send my free Heathkit Catalog now. I am not currently receiving your catalog.

Name \_\_\_\_\_

Address \_\_\_\_\_

City \_\_\_\_\_ State \_\_\_\_\_

CL-724A Zip \_\_\_\_\_

JANUARY 1980

CIRCLE 50 ON FREE INFORMATION CARD

75

are OK. Since you have a high-voltage problem, try a new high-voltage tripler; that would be a more likely cause.

(Feedback: Yes, it was indeed a very "bad tripler!")

**SHORT TUBE LIFE**

*This Penncrest model CB233 TV has a 16A8 tube that lasts only about 4 or 5 days to a week! I've monitored all the voltages on it, but can't see anything wrong. I have another model of this make with the same problem!—Y.S., Burlington, WI.*

There is one thing shown on the schematic diagram that might be causing this problem. A dropping diode is used in the heater string; result—reduced power. If this diode is leaky or shorted, it places the full sine-wave AC on it and overloads the tubes. Check the diode for leakage, or replace it. Incidentally, a sine-wave AC voltmeter will not measure the heater voltage correctly because this voltage is a half-wave pulsating AC. Take note that Sams shows only 10 volts across the 16A8 tube!

**HINT ON MAD MODULES**

RCA is now enclosing a note in its shipments of MAD modules that reads: "When using Module Stock No. 139685 as a replacement for Modules MAD001A-1H, 1J, 1P or 1R, it may be necessary to solder the pin tube socket leads to the external terminals of the module." This might be helpful.

**LUCK OR GENIUS?**

*Your crystal ball must have been really working in the April 1976 issue! A neighbor to the east of me had the intermittent-start horizontal oscillator problem; the neighbor to the west had the Zenith high-voltage regulator trouble! How do you do it?—L.H., Rochester, NY.*

There are two distinct schools of thought on this; one group favors genius, the other seems to lean more toward pure luck. As far as I can see, the second group has a slight edge—something like 97.3%. However, if it works take it!

**SHUTDOWN TROUBLE**

Thanks to your help, "we" finally found what was causing this model 19TS-949 Quasar to shut down after about 15-30 seconds! You said that it would shut down on both low and high voltages. I found that the 25-ohm, 20-watt resistor, R815, was cracked right under the metal clamp that holds it in place. The center wire wasn't broken, but the resistance was close. I replaced it and all system were go! I figure that the loose wire in the cracked insulator heated more at turn-on and was upsetting the anode voltage on the SCR, causing it to trip.—L.F., Fulton, MO.

R-E

Start Computing For Just \$129.95 With An 8085-Based Professional Computer Kit—

**Explorer/85**

100% compatible with all 8080A and 8085 software & development tools!

No matter what your future computing plans may be, Level "A"—at \$129.95—is your starting point.

Starting at just \$129.95 for a Level "A" operating system, you can now build the exact computer you want. Explorer/85 can be your beginner's system, OEM controller, or IBM-formatted B" disk small business system... yet you've never forced to spend a penny for a component or feature you don't want and you can expand in small, affordable steps!

Now, for just \$129.95, you can own the first level of a fully expandable computer with professional capabilities—a computer which features the advanced Intel 8085 cpu, thereby giving you immediate access to all software and development tools that exist for both the 8085 and its 8080A predecessor (they are 100% software compatible)—a computer which features onboard S-100 bus expansion—plus instant conversion to mass storage disk memory with either 5-1/4" diskettes or standard IBM-formatted B" disks.

For just \$129.95 (plus the cost of a power supply, keyboard/terminal and RF modulator, if you don't have them already), Explorer/85 lets you begin computing on a significant level... applying the principles discussed in leading computer magazines... developing "state of the art" computer solutions for both the industrial and leisure environment.

**Level "A" Specifications**

Explorer/85's Level "A" system features the advanced Intel 8085 cpu, an 8155 ROM with 2k deluxe monitor/operating system, and an 8155 ROM-I/O—all on a single motherboard with room for RAM/ROM/PROM/EPROM and S-100 expansion, plus generous prototyping space.

(Level "A" makes a perfect OEM controller for industrial applications and is available in a special Hex Version which can be programmed using the Netronics Hex Keypad/Display.)

**PC Board:** glass epoxy, plated through holes with solder mask

• I/O: provisions for 25-pin (DB25) connector for terminal serial I/O, which can also support a paper tape reader provision for 24-pin DIP socket for hex keyboard/display... cassette tape recorder input... cassette tape recorder output... speaker output... LED output indicator on SOD (serial output) line... printer interface (less drivers)... total of four 8 bit plus one 6 bit I/O ports • Crystal Frequency 6.144 MHz • Control Switches: reset and user (RST 2,3) interrupt... additional provisions for RST 5,3, 6,3 and TRAP interrupts onboard • Counter/Timer: programmable, 14-bit binary • System RAM: 256 bytes located at F800, ideal for smaller systems and for use as an isolated stack area in expanded systems... RAM expandable to 64k via S-100 bus or 4K on motherboard.

**System Monitor (Terminal Version):** 2k bytes of deluxe system monitor ROM located at F800 leaving F800 free for user RAM/ROM. Features include tape load with labeling... tape dump with labeling... examine/change contents of memory... insert data... warm start... examine and change all registers... single step with register display at each break point, a debugging/training feature... go to execution address... move blocks of memory from one location to another... fill blocks of memory with a constant... display blocks of memory... automatic baud rate selection... variable display line length control (1-255 characters/line)... channeled I/O monitor routine with 8-bit parallel output for high speed printer... serial console in and console out channel so that monitor can communicate with I/O ports.

**System Monitor (Hex Version):** Tape load with labeling... tape dump with labeling... examine/change contents of memory... insert data... warm start... examine and change all

- Netronics R&D Ltd., Dept. RE-1**  
333 Litchfield Road, New Milford, CT 06776  
Please send the items checked below—
- Explorer/85 Level "A" Kit (ASCII Version), \$129.95 plus \$3 p&h.
  - Explorer/85 Level "A" Kit (Hex Version), \$129.95 plus \$3 p&h.
  - 8k Microsoft BASIC on cassette tape, \$44.95 postpaid.
  - 8k Microsoft BASIC in ROM Kit (requires Levels "B," "D," and "E"), \$99.95 plus \$2 p&h.
  - Level "B" (S-100 Kit), \$49.95 plus \$2 p&h.
  - Level "C" (S-100 6-card expander) Kit, \$39.95 plus \$2 p&h.
  - Level "D" (4k RAM Kit), \$69.95 plus \$2 p&h.
  - Level "E" (EPROM/ROM) Kit, \$5.95 plus 50¢ p&h.
  - Deluxe Steel Cabinet for Explorer/85, \$49.95 plus \$3 p&h.
  - ASCII Keyboard/Computer Terminal Kit (features a full 128 character set, upper & lower case, full cursor control, 75 ohm video output convertible to baudot output, selectable baud rate, RS232-C or 20 ma. I/O, 32 or 64 character by 16 line format, and can be used with either a CRT monitor or a TV set (if you have an RF modulator)), \$149.95 plus \$2.50 p&h.
  - Hex Keypad/Display Kit, \$69.95 plus \$2 p&h.
  - Deluxe Steel Cabinet for ASCII Keyboard/Terminal, \$19.95 plus \$2.50 p&h.
  - Power Supply Kit (± 5V @ 5 amps) in deluxe steel cabinet, \$39.95 plus \$2 p&h.
  - Gold Plated S-100 Bus Connectors, \$4.85 each, postpaid.
  - RF Modulator Kit (allows you to use your TV set as a monitor), \$8.95 postpaid.
  - 16k RAM Kit (S-100 Board expands to 64k), \$199.95 plus \$2 p&h.
  - 32k RAM Kit, \$329.95 plus \$2 p&h.
  - 48k RAM Kit, \$459.95 plus \$2 p&h.
  - 64k RAM Kit, \$589.95 plus \$2 p&h.
  - 16k RAM Expansion Kit (to expand any of the above up to 64k), \$139.95 plus \$2 p&h each.
  - Intel 8085 cpu User's Manual, \$7.50 postpaid.
  - Special Computer Grade Cassette Tapes, \$1.90 each or 3 for \$5, postpaid.
  - 12" Video Monitor (10 MHz bandwidth), \$139.95 plus \$5 p&h.
  - North Star Double Density Floppy Disk Kit (One Drive) for Explorer/85 (includes 3 drive S-100 controller, DOS, and extended BASIC with per-



registers... single step with register display at each break point... go to execution address. Level "A" in the Hex Version makes a perfect controller for industrial applications and can be programmed using the Netronics Hex Keypad/Display.



Hex Keypad/Display.

**Hex Keypad/Display Specifications**

Calculator type keypad with 24 system defined and 16 user defined keys. 6 digit calculator type display which displays full address plus data as well as register and status information.

**Level "B" Specifications**

Level "B" provides the S-100 signals plus buffers/drivers to support up to six S-100 bus boards and includes: address decoding for onboard 4k RAM expansion select-able in 4k blocks... address decoding for onboard 8k EPROM expansion select-able in 8k blocks... address and data bus drivers for onboard expansion... wait state generator (jumper selectable), to allow the use of slower memories... two separate 3 volt regulators.



Explorer/85 with Level "C" card cage.

**Level "C" Specifications**

Level "C" expands Explorer's motherboard with a card cage, allowing you to plug up to six S-100 cards directly into the motherboard. Both case and cards are neatly contained inside Explorer's deluxe steel cabinet. Explorer's Level "C" includes a sheet metal superstructure, a 5-card gold plated S-100 extension PC board which plugs into the motherboard. Just add required number of S-100 connectors.

**Level "D" Specifications**

Level "D" provides 4k or RAM, power supply regulation, filtering decoupling components and sockets to expand your Explorer/85 memory to 4k (plus the original 256 bytes located in the 8155A). The static RAM can be located anywhere from 0000 to FFFF in 4k blocks.

**Level "E" Specifications**

Level "E" adds sockets for 8k of EPROM to use the popular Intel 2716 or the TI 2516. It includes all sockets, power supply regulator, heat sink, filtering and decoupling components. Sockets may also be used for soon to be available RAM IC's (allowing for up to 12k of onboard RAM).

**Order A Coordinated Explorer/85 Applications Pak!**

- Experimenter's Pak (SAVE \$12.50)—**Buy Level "A" and Hex Keypad/Display for \$199.90 and get FREE Intel 8085 user's manual plus FREE postage & handling!
- Student Pak (SAVE \$24.45)—**Buy Level "A," ASCII Keyboard/Computer Terminal, and Power Supply for \$314.35 and get FREE RF Modulator plus FREE Intel 8085 user's manual plus FREE postage & handling!
- Engineering Pak (SAVE \$41.00)—**Buy Levels "A," "B," "C," "D," and "E" with Power Supply, ASCII Keyboard/Computer Terminal, and six S-100 Bus Connectors for \$514.35 and get 10 FREE computer grade cassette tapes plus FREE 8085 user's manual plus FREE postage & handling!
- Business Pak (SAVE \$89.95)—**Buy Explorer/85 Levels "A," "B," and "C" (with cabinet), Power Supply, ASCII Keyboard/Computer Terminal (with cabinet), 16k RAM, 12" Video Monitor, North Star 5-1/4" Disk Drive (includes North Star BASIC) with power supply and cabinet, all for just \$1599.40 and get 10 FREE 5-1/4" diskettes (\$49.95 value) plus FREE 8085 user's manual plus FREE postage & handling!

Continental U.S.A. Credit Card Buyers Outside Connecticut  
**CALL TOLL FREE 800-243-7428**

To Order From Connecticut Or For Technical Assistance, Etc. Call (203) 354-9375

sonalized disk operating system—just plug it in and you're up and running!), \$699.95 plus \$5 p&h.

- Power Supply Kit for North Star Disk Drive, \$39.95 plus \$2 p&h.
- Deluxe Case for North Star Disk Drive, \$39.95 plus \$2 p&h.
- Experimenter's Pak (see above), \$199.90 postpaid.
- Student Pak (see above), \$319.85 postpaid.
- Engineering Pak (see above), \$514.35 postpaid.
- Business Pak (see above), \$1599.40 postpaid.

Total Enclosed \$ \_\_\_\_\_  
(Conn. res. add sales tax) By—  
 Personal Check  M.O./Cashier's Check  Visa  Master Charge  
(Bank # \_\_\_\_\_)

Acc. # \_\_\_\_\_  
Signature \_\_\_\_\_ Exp. Date \_\_\_\_\_  
Print Name \_\_\_\_\_  
Address \_\_\_\_\_  
City \_\_\_\_\_  
State \_\_\_\_\_ Zip \_\_\_\_\_  
 Send Mr Information



# new products

More information on new products is available. Use the Free Information Card inside the back cover.

**DUAL-TRACE, 20-MHZ OSCILLOSCOPE, model LBO-308**, is a 3-inch portable scope designed for field and lab applications, with power supplied

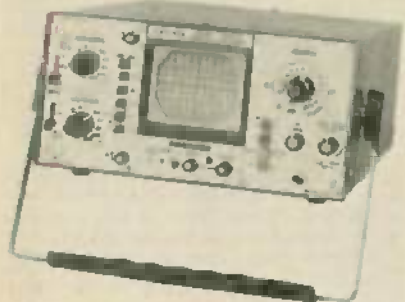

CIRCLE 151 ON FREE INFORMATION CARD

from AC/DC source or optional rechargeable battery pack. Specifications include a 2 mV-per-division sensitivity over 12 measurement ranges, a 17.5-ns risetime, X5 magnification, and a maxi-

mum sweep speed range of 0.1  $\mu$ s-per-division. The unit also has triggers for both channels and X-Y operation. The model LBO-308 comes with probes; carrying case is optional. Suggested retail price: \$950.—**Leader Instruments Corp.**, 151 Dupont St., Plainville, NY 11803.

**CALCULATOR, Model HP-41C**, has an alphanumeric LCD display and contains 130 preprogrammed scientific and mathematical functions. In addition, it can perform other calculations through programs written by the user or from applications software. Peripheral devices can be plugged into calculator for added capabilities: these include a memory module to increase program memory, a card reader to enter and record programs, a thermal printer for output, a wand that enters programs optically, and 16 applications modules for solving problems in specific areas.

Other features of the calculator include editing powers, comparing data and results, word messages indicating calculation errors, keyboard overlays, labels for addressing parts of programs, and a continuous memory that retains programs



CIRCLE 152 ON FREE INFORMATION CARD

and data even when power is shut off. Price is \$295.00. Plug-in devices sold separately.—**Hewlett Packard**, 1501 Page Mill Rd., Palo Alto, CA 94304.

**MAGNETIC 5-IN-1 SCREWDRIVER, model 70425**, is designed for use in home, shop, garage or factory applications. A built-in magnet in the shank holds extra bits and the screw. The Com-

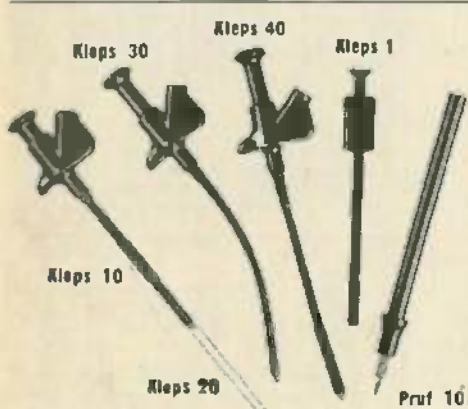

## Clever Kleps

Test probes designed by your needs—Push to seize, push to release (all Kleps spring loaded).

- Kleps 10.** Boathook clamp grips wires, lugs, terminals. Accepts banana plug or bare wire lead. 4 3/4" long. \$2.84
  - Kleps 20.** Same, but 7" long. \$4.48
  - Kleps 30.** Completely flexible. Forked-tongue gripper. Accepts banana plug or bare lead. 6" long. \$3.19
  - Kleps 40.** Completely flexible. 3-segment automatic collet firmly grips wire ends, PC-board terminals, connector pins. Accepts banana plug or plain wire. 6 1/4" long. \$4.59
  - Kleps 1.** Economy Kleps for light line work (not lab quality). Meshing claws. 4 1/2" long. \$2.46
  - Prof 10.** Versatile test prod. Solder connection. Molded phenolic. Doubles as scribing tool. "Bunch" pin fits banana jack. Phone tip. 5 1/2" long. \$2.37
- All in red or black - specify. (Add 50¢ postage and handling). Write for complete catalog of - test probes, plugs, sockets, connectors, earphones, headsets, miniature components.

Available through your local distributor, or write to:  
**RYE INDUSTRIES INC.**  
 132 Spencer Place, Mamaroneck, N.Y. 10543  
 In Canada: Rye Industries (Canada) Ltd.

CIRCLE 3 ON FREE INFORMATION CARD



## INTERNATIONAL FM-2400CH FREQUENCY METER FOR TESTING MOBILE TRANSMITTERS AND RECEIVERS

Portable • Solid State • Rechargeable Batteries

The FM-2400CH provides an accurate frequency standard for testing and adjustment of mobile transmitters and receivers at predetermined frequencies.

The FM-2400CH with its extended range covers 25 to 1000 MHz.

The frequencies can be those of the radio frequency channels of operation and/or the intermediate frequen-

cies of the receiver between 5 MHz and 40 MHz.

Frequency stability:  $\pm 0.0005\%$  from  $+50^\circ$  to  $+104^\circ\text{F}$ .

Frequency stability with built-in thermometer and temperature corrected charts:  $\pm 0.00025\%$  from  $+25^\circ$  to  $+125^\circ$  (0.00125% special 450 MHz crystals available).

- Tests Predetermined Frequencies 25 to 1000 MHz
- Extended Range Covers 950 MHz Band
- Pin Diode Attenuator for Full Range Coverage as Signal Generator
- Measures FM Deviation

FM-2400CH (meter only) ..... \$627.72

RF crystals (with temperature correction) ..... 26.26 ea

RF crystals (less temperature correction) ..... 19.83 ea

IF crystals ..... catalog price

Write for catalog



CIRCLE 29 ON FREE INFORMATION CARD



INTERNATIONAL CRYSTAL MFG. CO. INC.  
 10 North Lee, Oklahoma City, Okla. 73102



# THIS VISE IS CATCHING.

Catch PanaVise. It tilts, turns and rotates your work exactly where you want. Add our new Tray! It catches small parts you drop, separates tools, and keeps parts sorted. The Tray's wide 8 1/4" diameter of cast metal gives 'no-tip' stability, and has 6 slip resistant neoprene feet. Catch all the PanaVise combinations at your distributors now. Write for FREE brochure and distributor list.

**PANA VISE®**

Dept. CE 11  
2850 29th St.  
Long Beach, CA 90806

Shown:  
#315 Circuit Board Holder, #300 Base, #312 Tray Base Mount.



CIRCLE 45 ON FREE INFORMATION CARD

## 8 Instruments in 1

- Out-of-Circuit Transistor Analyzer
- Dynamic In-Circuit Transistor & Radio Tester
- Signal Generator
- Signal Tracer
- Voltmeter
- Milliammeter
- Battery Tester
- Diode Checker



Model  
**Transistor Analyzer 212**  
Factory Wired & Tested — \$35.98  
Easy-to-Assemble Kit — \$23.97

Now you can pinpoint defective transistors and their circuit troubles speedily with a single, feature-packed instrument instead of a costly elaborate set-up. Performance-proven by thousands! Checks all transistor types, hi or low power, for DC current gain (beta) to 200 in 3 ranges, and leakage.

Universal test socket accepts all base configurations. Identifies NPN or PNP transistors. Dynamically tests all transistors (oscillator check) and AF, IF, RF circuits.

No external power needed. Measures DC currents to 80 ma. Complete with test leads, instruction manual and transistor listing.

Write for FREE catalog of the world-famous EMC line of test instruments.

**EMC** ELECTRONIC MEASUREMENTS CORP.  
625 Broadway, New York, NY 10012

## TUNER SUB \$19.95

Since all tuner subs that we know of are modified TV Tuners, we decided to market an excellent performing yet very low cost sub for the technician who has to get all he can for his money . . . a "Poor Boy's Sub" for only \$19.95.

This was not an easy task since cabinets, knobs and controls would push the price far above \$19.95 . . . We searched for a tuner that needed no cabinet and no controls . . . one that the tech could scrounge the knobs from most any old TV . . .

It took over two years but we finally found it. The gain is excellent . . . Battery drain is very low (only 18 mils). It's self biasing so there is no R.F. gain control to fiddle with . . . It works equally well on tube or transistor sets . . . b/w or color . . . and is as easy to use as starting a light with your wife (well, almost). All you need do is hook the set's IF cable to the "Poor Boy" and view the picture . . . That's it . . . no set up controls to confuse you.

We compared the "Poor Boy" with other subs costing over twice the price and found it to work just as well on all the comparison tests we made . . . and often a lot easier to use . . . Even though instructions aren't needed . . . you get those too.

The "Poor Boy" is small enough to easily hold in one hand . . . no wires or controls dangling around it. It comes completely wired and tested including batteries and ready to use. Send a check for only \$19.95, plus \$1.50 shipping.

Master Charge and Visa accepted  
Try it for 10 days . . . if not completely satisfied . . . return for full refund.

CALL TOLL FREE 1-800-433-7124

**TEXAS TUNER SERVICE**  
4210 N.E. 28TH STREET,  
FORT WORTH, TEXAS 76117

CIRCLE 52 ON FREE INFORMATION CARD

## NEW PRODUCTS continued from page 77

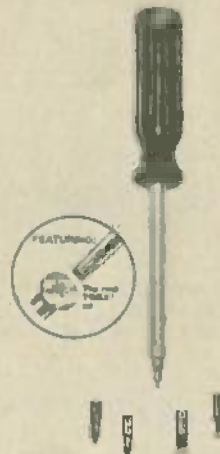

CIRCLE 153 ON FREE INFORMATION CARD

The *toridome* handle features a removable dome cap that stores the 4 extra bits inside the shaft while the fifth bit is in use. The bits include the Torx T15, a 1/8-in. and a 1/16-in. regular, plus No. 1 and No. 2 Phillips bits—Vaco Products Co., 1510 Skokie Blvd., Northbrook, IL 60062.

**DESOLDERING WICK, 3S-Wick**, comes in spools containing a 5-foot, 5-inch length and costs \$.49 each for OEM quantities of 5000. Each spool is

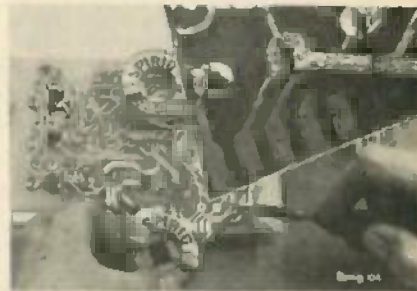

CIRCLE 154 ON FREE INFORMATION CARD

worth about 250 desoldering operations.—Solder Absorbing Technology, Inc., 357 Cottage St., Springfield, MA 01104.

**MODULE REBUILDING SERVICE** accepts all makes of remote control transmitters for rebuilding, including Admiral, GE, Magnavox, Quasar, RCA, GTE-Sylvania, Zenith, Packard Bell, Ad-



CIRCLE 155 ON FREE INFORMATION CARD

vent, Sanyo and Truetone. Information on specific transmitter and module numbers, etc., can be obtained by writing the company.—PTS Electronics, Inc., 5233 S. Highway 37, Bloomington, IN 47401. R-E

# stereo products

More information on stereo products is available. Use the Free Information Card inside the back cover

**CAR STEREO EQUIPMENT LINE**, 20 models (model SR2100 shown) ranging from under-dash 8-track and cassette units to 8-track/cassette AM/FM stereo radio combinations, several with

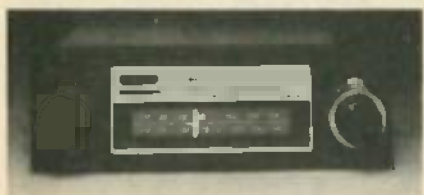

CIRCLE 131 ON FREE INFORMATION CARD

digital displays. Many units feature loudness, muting, high-filter and AM/FM controls; LED indicators; audio-reverse cassette; and automatic key-off reject. Suggested retail price for the model SR2100, \$219.95.—Sparkomatic Corp., Milford, PA 18337.

**EXTENDED-RESPONSE PHONO CARTRIDGE**, model EDR.9, has an aluminum cantilever with a nude-mounted diamond stylus. The stylus has a 0.3 by 3.0-mil radius. Other specifications: frequency response, 10 Hz–50 kHz, 20 Hz–35 kHz  $\pm 1\%$  dB; tracking force range,  $\frac{1}{4}$ – $1\frac{1}{4}$  grams;



CIRCLE 132 ON FREE INFORMATION CARD

separation, 20 dB at 20 Hz–5 kHz; compliance,  $28 \times 10^{-8}$  cm-per-dyne; power output, 4.5 mV at 5 cm-per-second. The cartridge weighs 5.2 grams, and sells for a suggested retail price of \$199.—Empire Scientific Corp., 1055 Stewart Ave., Garden City, NY 11530.

**LOUDSPEAKER SYSTEMS**, models XP20, XP40, XP60, XP80, are acoustic suspension high-fidelity systems. The model XP20 is a two-way coaxial system with a frequency response of 65 Hz–18 kHz,  $\pm 3$  dB, a sensitivity of 88 dB at 1 watt/1 meter, and can handle up to 30 watts input. The speaker measures 14 H X 9.7 W X 8.7 inches D. The model XP40 has an 8-inch woofer and a  $\frac{1}{2}$ -inch midrange/tweeter, provides a frequency response of 63 Hz–20 kHz,  $\pm 3$  dB, an 88-dB sensitivity at 1 watt/1 meter, and a maximum input of 35 watts. The unit measures 18.7 H X 9.7 W X 9.4 inches D. The model XP60 (shown) is a three-way system with a sensitivity of 87 dB at 1 watt/1



CIRCLE 133 ON FREE INFORMATION CARD

meter and a power-handling capability of 40 watts. It features a  $\frac{1}{2}$ -inch tweeter, a 4-inch mid-range driver and an 8-inch woofer. The unit measures 18.7 H X 10.4 W X 9.4 inches D. The model XP80 uses a 10-inch woofer to provide a low bass response. It has a sensitivity rating of 86 dB/1 watt/1 meter, and a maximum power-handling capability of 50 watts; it measures 22.2 H X 12 W X 10.4 inches D. All speaker enclosures are teak or walnut veneer with a brown grille cloth and come in pairs. Suggested retail prices: XP20, \$90, XP40, \$115; XP60, \$160; XP80, \$210.—Renk Hi Fi Inc., 20 Bushes Lane, Elmwood Park, NJ 07407.

**AM/FM STEREO RECEIVER**, Spatial Control receiver, provides 100 watts-per-channel, contains four amplifiers and features a spatial slide control. Slide control is used in conjunction with the

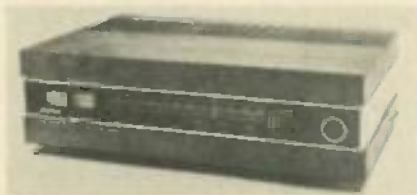

CIRCLE 134 ON FREE INFORMATION CARD

model 901 Direct-Reflecting loudspeakers to narrow or widen the aural image. Also available is a 40-watt stereo receiver, the model 550. Suggested retail prices: the Spatial Control receiver, \$799; the model 550, \$349.—Bose Corp., 100 The Mountain Rd., Framingham, MA 01701.

**SOUND/SPEAKER CONTROL SYSTEMS**, Series CD. Audio control systems provide simultaneous tape recorder playback, dubbing, record, mixing and monitoring capabilities using single patchcord. The model CD-5 system controls three tape

## Discover today's high-resolution 3½-digit DMM

### B&K-PRECISION's LCD Model 2815



Model 2815 \$150

- 0.01 ohm, 100nA, 100 $\mu$ V resolution
- 0.1% DC accuracy
- Shielded and protected to stay accurate in rf fields
- Fully overload protected on all ranges
- Auto-zero and auto-polarity
- Alternating high-/low-power ohms ranges for solid-state circuitry measurements

Compare the resolution offered by the new B&K-PRECISION Model 2815 with any other DMM in its price class. Its high resolution stands alone. The 2815 also delivers 0.1% DC and 0.3% AC accuracy. For added convenience, a tilt stand is built-in.

Available for immediate delivery at your local B&K-PRECISION distributor

**BK PRECISION**  
**DYNASCAN CORPORATION**

6460 West Cortland Street  
Chicago, Illinois 60635 • 312/889-9087

In Canada: Atlas Electronics Ontario  
Unit Six Empire Exp. 270 Newtown Rd. Paramar, L.I. 191803

CIRCLE 53 ON FREE INFORMATION CARD

**STEREO PRODUCTS**  
continued from page 79



**CIRCLE 135 ON FREE INFORMATION CARD**

recorders plus an amplifier/receiver and contains a fade control. The model CD-10 monitors six tape recorders (reel-to-reel, cassette or 8-track

units), an amplifier/receiver and signal processors. It also features a fade control and 10-position switch. The model CD-35 (shown) handles five tape recorders plus an amplifier/receiver and signal processors; it contains a 12-position switch and auxiliary control to monitor a sixth tape recorder. The speaker control system (the model CD-25) can accommodate up to four sets of speakers, contains 10-position control switch and can handle 20 watts-per-channel. Suggested retail prices: model CD-5, \$99.95; model CD-10, \$149.95; model CD-35, \$399.95; model CD-25, \$189.95.—Duble Corp., 1725 Ladens Trail, Dayton, OH 45459.

**CASSETTE DECK, model RS-M65**, uses a built-in frequency generator servomotor, providing a 0.3% tape speed deviation and 0.035% WRMS wow-and-flutter. The model RS-M65 is rack-mountable, and offers the following features: a removable tape compartment door, a muling



**CIRCLE 136 ON FREE INFORMATION CARD**

switch, timer controls, a PAUSE control, a 3-position bias and equalization selector control, a MEMORY REWIND switch, Dolby with multiplex filter, input/output selector switches, mike jacks, left and right input/output level controls, a fluorescent meter, and a tape counter. Suggested retail price: \$550.—Technics, One Panasonic Way, Secaucus, NJ 07094.

**STEREO RECEIVER, model STA-240**, delivers 80 watts-per-channel RMS minimum into 8 ohms, 20 Hz-20 kHz, with no more than 0.15% THD, and provides a sensitivity of 1.9  $\mu$ V and a capture ratio of 1.5 dB. The receiver's features include automatic AM bandwidth control; digital frequency readout plus slide-rule tuning dial; Auto-Magic



**CIRCLE 137 ON FREE INFORMATION CARD**

FM tuning; tape dubbing and monitor switches; 5-point LED signal-strength indicator; high-cut and low-cut filter switches; a 25-75- $\mu$ s de-emphasis switch; and input/output jacks. The model STA-240 is housed in a walnut veneer wood cabinet, and carries a suggested retail price of \$429.95.—Radio Shack, 1400 One Tandy Center, Fort Worth, TX 76102. R-E

# Reach for SPRAGUE components instead of running for them.



Choose from 24 packaged assortments to get a balanced inventory of capacitors, resistors, or solderless terminals.

You don't have to buy a huge quantity of electronic components to build and maintain a practical-sized inventory. Nor do you have to put a big strain on your budget. Each Sprague Assortment contains a practical selection of ratings and types most frequently used in your service work or hobby needs.

Larger capacitor and resistor assortments are supplied in 15-drawer blue metal cabinets, fitted with a retractable carrying strap. Smaller assortments come in stackable 9-drawer blue plastic cabinets. Clear plastic drawers have adjustable dividers. Pre-labeled drawer fronts identify contents.

Solderless terminal assortments are supplied in compartmented hinged-lid clear plastic storage cases.

**YOU PAY FOR COMPONENTS ONLY... CABINETS ARE YOURS AT NO EXTRA COST.**

**SPRAGUE PRODUCTS COMPANY** (Distributors' Division of Spelco Electric Co.)  
81 Marshall Street, North Adams, Mass. 01247

YES... send me a FREE copy of your new M-636 Brochure including complete descriptions and prices on all 24 assortments.

Name \_\_\_\_\_  
Company (if applicable) \_\_\_\_\_  
Address \_\_\_\_\_  
City \_\_\_\_\_  
State \_\_\_\_\_ Zip \_\_\_\_\_



**CIRCLE 48 ON FREE INFORMATION CARD**

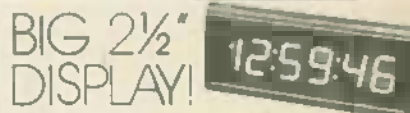

## BIG 2 1/2" DISPLAY! SOLID STATE CLOCK/CALENDAR KIT

0101 Displays time of day, date or alternate between both automatically. May be connected to 8 ohm speaker for alarm clock. Operates from 120 VAC 60 Hz.  
\$49.95 Walnut case extra, \$24.95

## AUTO CLOCK CALENDAR KIT

0108 Displays either hours and minutes, month and day, or seconds. Requires only 2 mA of current while ignition is off. Also operates on 9V battery. Mounts easily in compact two-inch enclosure (Not included).  
\$29.95  
\$39.95 assembled

## UNIVERSAL DESIGNER KIT

6100 Indispensable aid to digital IC design. 2 pushbuttons, 2 readouts, 4 switch outputs, 8 LEDs, 2 generators, 2 counters, 5V supply pins. Shown with CSC QT47S Breadboard (not included).  
\$39.95  
\$49.95 assembled

SEND FOR FREE 8-PAGE CATALOG  



14905 N.E. 40th Street, R-1  
Redmond, WA 98052 (206) 883-9200

**CIRCLE 40 ON FREE INFORMATION CARD**

# market center

**CLASSIFIED COMMERCIAL RATE** (for firms or individuals offering commercial products or services) \$1.50 per word (no charge for zip code) . . . minimum 15 words.

**NONCOMMERCIAL RATE** (for individuals who want to buy or sell personal items) 85¢ per word . . . no minimum.

**ONLY FIRST WORD AND NAME** set in bold caps. Additional bold face (not available as all caps) at 10¢ per word. Payment must accompany all ads except those placed by accredited advertising agencies. 5% discount for 6 issues, 10% for 12 issues within one year, if paid in advance. All copy subject to publisher's approval. Advertisements using P.O. Box address will not be accepted until advertiser supplies publisher with permanent address and phone number. Copy to be in our hands on the 26th of the third month preceding the date of the issue (i.e., August issue closes May 26). When normal closing date falls on Saturday, Sunday, or a holiday, issue closes on preceding working day.

## PLANS & KITS

**CONSTRUCTION** plans for profitable business ideas. Catalog \$1.00. **GARLING**, 438 N. Garfield Street, Lombard, IL 60148

**ELECTRONICS** completed kits. No wiring. FM mic. VU meter. Touch control switch. Programmable music block. Wheel fortune game. Etc. Save up to 50%. Write for free catalog today. Postcard will do. **SUPERTRONICS INC.**, 39 Bowery, Box 88, New York, NY 10002

**AUDIO** mixers, preamps, meters. Schematics, construction guides. SASE brings free list. **PAM ELECTRONICS**, 3424 Memorial St., Alexandria, VA 22306

**NEGATIVE** ion generator, build one yourself with easy-to-get parts and save %50 to %75. Includes ozone check. Plans \$5.00. **LUNATRIX**, Box 891, Yucaipa, CA 92399

**TRS-80** add up to 16 fully decoded 8 bit input and output ports. Plans 7.95, info \$.50. **DAPAR ELECTRONICS**, 17 Jennings St., Springfield, MA 01119

## HIGHLY PROFITABLE ONE-MAN ELECTRONIC FACTORY

Investment unnecessary, knowledge not required, sales handled by professionals. Ideal home business. Write today for facts! Postcard will do. **Barta-RE-Y**, Box 248, Walnut Creek, CA 94597.

**NR-2** adaptive noise filter kit as featured in Radio-Electronics August, September issues. Reduces audio noise 12 dB. Works with all program sources; tape, or FM broadcast. Even works with Dolby systems. \$69.95. Free information. Dealer inquiries invited. **ADVANCED AUDIO SYSTEMS**, P.O. Box 24, Los Altos, CA 94022

**PROJECTION TV**. . . Convert your TV to project 7 foot picture. Results equal to \$2,500 projector. Total cost less than \$20.00. Plans & lens \$16.00. Illustrated information free. **MACRO-COMGD**, Washington Crossing, PA 18977

## Burglar Fire Protection

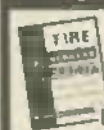

Protect Your Life, Home, Business, Auto, etc.

• Our catalog shows how to install your own alarm systems and devices and save \$\$\$\$. We offer FREE write-in engineering service.

**FREE CATALOG** Lowest Prices on Reliable, Top Quality Alarm Systems and Devices

**Burdex Security Co.** Box 82802-RE Lincoln, Ne. 68501

**PRINTED** circuit boards from sketch or artwork. Kit projects. Free details. **DANOCINTHS INC.**, Box 261, Westland, MI 48185

**EVEN** cheap speakers can sound expensive in proper enclosure. Plans/inst. \$3.50. **F. E. CONLEY**, Box 976, Tulare, CA 93274

**ELECTRONIC** organ kits. The ultimate design. Sounds like a pipe organ. Build it to sell or build it to keep. Models for churches, homes, clubs, pizza parlors. Send \$1.00 for demo record and catalog. **DEVTRONIX**, Dept. 70, 6101 Warehouse Way, Sacramento, CA 95826

## TESLA COIL

**TESLA** coil resonant transformers. 50,000-5,000,000 volts. 520W-3000 kilowatts, arcs—100". Illustrated construction manual includes: 5 powerful coil plans (tube, sparkgap), electrical theory, designing procedures, 25 high-voltage, high-frequency experiments, history. Part suppliers . . . Manual \$15.00. Information/photo \$2.00. **ASTRO-ENGINEERING**, 2706 Harbor Blvd., Costa Mesa, CA 92626

## GRAPHIC EQUALIZER

**TWELVE** bands/channel \$100 kit, still available; see May 1978 R/E cover story or write. **SYMMETRIC SOUND SYSTEMS**, 912 Knobcone Place, Dept. R, Loveland, CO 80537

**ATV Research** ...specialists in CCTV and computer monitors!

Video monitors - color & B/W • TV Cameras, kits, parts & plans • Video-to-RF modulators • Free catalog. Phone or write. (402) 967-3771

13-RE Broadway      Dakota City, NE. 68731

## BUSINESS OPPORTUNITIES

**MECHANICALLY** inclined individuals desiring ownership of Small Electronics Manufacturing Business—without investment. Write: **BUSINESS-ES**, 92-R, Brighton 11th, Brooklyn, NY 11235

**LEARN** to repair PLL or crystal synthesis CB for profit. 30 PLL's covered. Send \$12.95 for instruction book. **A.P. SYSTEMS**, PO Box 488, Millford, PA 18337, Dept. RE

**BECOME** a semiconductor distributor full or part time. Here is a rare opportunity to engage yourself with one of America's leading suppliers of original Japanese semiconductors and exact replacement parts. Sell directly to retail outlets, repair shops, service technicians and manufacturers. Complete product line, backed up by a 40 million dollar inventory, priced to sell up to 50% lower than the leading replacement line. All products guaranteed. No investment required. Live wires only. Write to: **NEW-TONE ELECTRONICS INTERNATIONAL**, P.O. Box 1739, Bloomfield, NJ 07003

**NEW** tax loopholes discovered. Everyone eligible. Unique ideas. Free facts. **ULC**, Box 359 BC, Clarkston, GA 30021

To run your own classified ad, put one word on each of the lines below and send this form along with your check for \$1.50 per word (minimum 15 words) to:

Radio-Electronics, 200 Park Avenue South, N.Y., N.Y. 10003

### ORDER FORM

PLEASE INDICATE in which category of classified advertising you wish your ad to appear. For special headings, there is a surcharge of \$10.

Plans/Kits     Business Opportunities     For Sale  
 Education/Instruction     Wanted   

Special Category: \$10

(PLEASE PRINT EACH WORD SEPARATELY, IN BLOCK LETTERS.)

1	2	3	4	5
6	7	8	9	10
11	12	13	14	15
16	17	18	19	20
21	22	23	24	25
26	27	28	29	30
31	32	33	34	35

## PASS FCC EXAMS

The Original FCC Test Answer Manual that provides you at home for FCC First and Second class Radiotelephone Stations. Newly revised multiple choice questions cover all tests covered on the actual FCC exam. Plus "Self Study" Ability Test. Proved 99.99% Money Back Guarantee.



COMMERCIAL PRODUCTIONS  
Radio Electronics Division

P.O. Box 26348 E  
San Francisco, CA 94126

## EDUCATION & INSTRUCTION

TELEPHONE bugged? Don't be Watergated! Countermeasures brochure \$1.00. NEGEYE LABORATORIES, Box 547-RE, Pennsboro, WV 26416

UNIVERSITY degrees by mail! Bachelors, Masters. Ph.D's . . . Free revealing details. COUNSELLING, Box 317-RE1, Tustin, CA 92680

## ELECTRONIC MUSIC

ELECTRONIC music and home recording in Polyphony magazine. Advanced applications, interviews, projects, computer music. Sample, \$1.50. Subscription (6 issues), \$8 US/\$10 foreign. POLYPHONY, Box R20305, Okla. City, OK 73156.

## FOR SALE

RADIO & TV tubes 35¢ each. One year guaranteed. Plus many unusual electronic bargains. Free catalog. CORNELL, 4217-E University, San Diego, Calif. 92105

NAME brand test equipment. Guaranteed discounts up to 50%. Free catalog. SALEM ELECTRONICS, Box 82-M, Skokie, IL 60077

PRINTED-circuit boards, reasonable. Also, artwork, prototypes, design, fabrication and testing. MICROCON INC., Box 43, Glenview, IL 60025

AUDIO noise reduction kit—318 attenuator for tapes, records, FM. Free brochure. LOGICAL SYSTEMS, 3314 "H" St., Vancouver, Washington 98663.

SCANNER/monitor accessories—kits and factory assembled. Free catalog. CAPRI ELECTRONICS, Route 1R, Canon, GA 30520

FREE catalog. IC's, LED's, semi's, parts. CORONET ELECTRONICS, 649A Notre Dame W., Montreal, Que., Canada H3C 1H8. U.S. inquiries.

RECONDITIONED test equipment. \$1.00 for catalog. JAMES WALTER TEST EQUIPMENT, 2697 Nickel, San Pablo, CA 94806

HAMS, CBers, SWLs—eight character morse-A-word morse code reader; RTTY reader. Decodes signals off the air. Send for details. MICROCRAFT CORPORATION, Box 513R, Thiensville, WI 53092 1-414-241-8144.

NEW Fall 1979 test equipment catalog available. 108 pages of quality used equipment. Write for free copy. TUCKER ELECTRONICS CO., Box 401060, Garland, TX 75040

4 in kit of CAPACITANCE MEYER 1pF to 999KpF  
FREQUENCY COUNTER 35MHz  
SQUARE WAVE GEN. 1Hz to 99KHz-  
OHMMETER - 3.58MHz Xtal - Regulated PS - Five  
8" Readouts - Low cost TTL Circuits - Automatic  
Decimal Placement - Be AMAZED - Satisfaction  
Guaranteed. I Purchase the Plans, etched P.C.  
board 4-3/4" by 6-3/4" and front panel decal  
for \$15.29! BARNALL ELECTRONICS, 800  
179 May Street, Fairfield, Conn. 06430

OSI challenger 1P-Superboard II 90-page step-by-step programming manual, \$5.95 + \$1.00 P&H. TIS, Box 921RE, Los Alamos, NM 87544

SATELLITE Television—movies, sports, etc. Build or buy your own Earth Station. Send \$3.00 for information. SATELLITE TELEVISION, Box 140, Oxford, NY 13830

PICTURE TUBE MACHINE  
We buy and sell NEW and USED CRT  
rebuilding machinery. COMPLETE  
TRAINING. Buy with CONFIDENCE from  
the ORIGINAL MFGA.  
For complete details send name, address  
zip to  
LAKESIDE INDUSTRIES  
4073 W. Egan Avenue  
Chicago, IL 60618  
Phone: 312-583-6565

SURPLUS electronics. Monthly picture flyer. Low prices. U.S. only. STAR-TRONICS, Box 683, McMinnville, OR 97218

VIDEO tape recorder—closeout—Shibaden SV-700-UC new factory cartons—\$375.00 Job Loveland—Details available. LOVELAND ENGINEERING & ELECTRONICS, 6651 Epworth Road, Loveland, OH 45140

CARBIDE drills—#65 (.035"). New. 1/2 shank. Two for \$7.95. Each additional, \$3.70@. Postpaid. CM CIRCUITS, 22 Maple Avenue, Lackawanna, NY 14218

AMAZING ELECTRONIC PROJECTS and PRODUCTS:  
Lasers Super Powered Burning, Cutting, Rifle, Pistol, Pocket. See in Dark—Shogun Directional Mike—Unscramblers—Giant Tesla—Stunwand—TV Disrupter—Energy Producing, Surveillance, Detection, Electrifying, Ultrasonic, CB, Auto and Mech. Devices, Hundreds More—All New Plus INFO UNLTD PARTS SERVICE Catalog \$1. Information Unlimited, Dept. R8 Box 716 Amherst, N.Y. 03031.

**STEREO PAIR SPEAKER SYSTEM**  
**1199** SP-638  
Reg. ~~1799~~  
•Mar-Proof Walnut Vinyl Finish Over Particle Board  
•17 1/2 x 10 x 4 1/2"  
•8 Ohms •17 lbs.

**BEARFINDER AUTO BURGLAR ALARM**  
NEW ITEM  
•Utilizes Vehicles Horn  
•Installs In Minutes  
•5x3x1 1/2" •Wt. 12 Ozs.  
**999** AU-775

**6 x 9" 5.5 OZ. MAGNET HEAVY-DUTY SPEAKER**  
**299** Reg. ~~349~~  
SP-626  
•4-8 Ohms •Dust Cover  
•For Auto, Van, RV and Home Use •Wt. 3 lbs.

**12 VOLT MINI BLOWER**  
**99¢** Reg. ~~249~~  
MO-452  
•1 1/2" Dia. x 2 1/2" Long  
•12VDC Fan/Motor •1/2 lb.

**PENCIL-TIP SOLDERING IRON**  
**229** Reg. ~~399~~  
TL-448  
•9 1/2" Long  
•Tip Reaches 250° •Wt. 1/4 lb.

**8-TRACK TAPE**  
**69¢** TA-907  
Reg. ~~149~~  
•40-Minute Recording Tape  
•Quality Reproduction

**REEL-TO-REEL TAPE**  
**69¢** TA-608  
Reg. ~~149~~  
•10" Reel  
•2400 Feet  
•High Quality •Wt. 1/2 lb.

**60-MIN. BLANK CASSETTE**  
Pkg. of 3 **87¢** TA-879  
29¢ Each  
•Pkg of 3 •Ideal for Music  
•60-Minutes or Voice

**Olson Electronics**  
Dept. P-1 260 S. Forge St. Akron, Ohio 44327

NAME \_\_\_\_\_  
ADDRESS \_\_\_\_\_  
CITY \_\_\_\_\_  
STATE \_\_\_\_\_ ZIP \_\_\_\_\_

Qty	Size	Description	Price Ea	Total

CHARGE CARD ORDERS OVER \$25  
**CALL FREE 1-800-321-2424**  
OHIO RESIDENTS CALL 1-216-535-1800

FREE! Please send me a free subscription to Olson Value Packed Catalog.

Tax \_\_\_\_\_  
Postage \_\_\_\_\_  
Total \_\_\_\_\_

RADIO-ELECTRONICS



3 am | easy alignment. First line parts only. Factory tested. Guaranteed money back. Quality IC's and other components in factory prices.

INTEGRATED CIRCUITS

Table listing various integrated circuits with columns for part number, manufacturer, and price. Includes sections for 8085, 8088, 8080, 8086, 8087, 8089, 8090, 8091, 8092, 8093, 8094, 8095, 8096, 8097, 8098, 8099, 8100, 8101, 8102, 8103, 8104, 8105, 8106, 8107, 8108, 8109, 8110, 8111, 8112, 8113, 8114, 8115, 8116, 8117, 8118, 8119, 8120, 8121, 8122, 8123, 8124, 8125, 8126, 8127, 8128, 8129, 8130, 8131, 8132, 8133, 8134, 8135, 8136, 8137, 8138, 8139, 8140, 8141, 8142, 8143, 8144, 8145, 8146, 8147, 8148, 8149, 8150, 8151, 8152, 8153, 8154, 8155, 8156, 8157, 8158, 8159, 8160, 8161, 8162, 8163, 8164, 8165, 8166, 8167, 8168, 8169, 8170, 8171, 8172, 8173, 8174, 8175, 8176, 8177, 8178, 8179, 8180, 8181, 8182, 8183, 8184, 8185, 8186, 8187, 8188, 8189, 8190, 8191, 8192, 8193, 8194, 8195, 8196, 8197, 8198, 8199, 8200, 8201, 8202, 8203, 8204, 8205, 8206, 8207, 8208, 8209, 8210, 8211, 8212, 8213, 8214, 8215, 8216, 8217, 8218, 8219, 8220, 8221, 8222, 8223, 8224, 8225, 8226, 8227, 8228, 8229, 8230, 8231, 8232, 8233, 8234, 8235, 8236, 8237, 8238, 8239, 8240, 8241, 8242, 8243, 8244, 8245, 8246, 8247, 8248, 8249, 8250, 8251, 8252, 8253, 8254, 8255, 8256, 8257, 8258, 8259, 8260, 8261, 8262, 8263, 8264, 8265, 8266, 8267, 8268, 8269, 8270, 8271, 8272, 8273, 8274, 8275, 8276, 8277, 8278, 8279, 8280, 8281, 8282, 8283, 8284, 8285, 8286, 8287, 8288, 8289, 8290, 8291, 8292, 8293, 8294, 8295, 8296, 8297, 8298, 8299, 8300, 8301, 8302, 8303, 8304, 8305, 8306, 8307, 8308, 8309, 8310, 8311, 8312, 8313, 8314, 8315, 8316, 8317, 8318, 8319, 8320, 8321, 8322, 8323, 8324, 8325, 8326, 8327, 8328, 8329, 8330, 8331, 8332, 8333, 8334, 8335, 8336, 8337, 8338, 8339, 8340, 8341, 8342, 8343, 8344, 8345, 8346, 8347, 8348, 8349, 8350, 8351, 8352, 8353, 8354, 8355, 8356, 8357, 8358, 8359, 8360, 8361, 8362, 8363, 8364, 8365, 8366, 8367, 8368, 8369, 8370, 8371, 8372, 8373, 8374, 8375, 8376, 8377, 8378, 8379, 8380, 8381, 8382, 8383, 8384, 8385, 8386, 8387, 8388, 8389, 8390, 8391, 8392, 8393, 8394, 8395, 8396, 8397, 8398, 8399, 8400, 8401, 8402, 8403, 8404, 8405, 8406, 8407, 8408, 8409, 8410, 8411, 8412, 8413, 8414, 8415, 8416, 8417, 8418, 8419, 8420, 8421, 8422, 8423, 8424, 8425, 8426, 8427, 8428, 8429, 8430, 8431, 8432, 8433, 8434, 8435, 8436, 8437, 8438, 8439, 8440, 8441, 8442, 8443, 8444, 8445, 8446, 8447, 8448, 8449, 8450, 8451, 8452, 8453, 8454, 8455, 8456, 8457, 8458, 8459, 8460, 8461, 8462, 8463, 8464, 8465, 8466, 8467, 8468, 8469, 8470, 8471, 8472, 8473, 8474, 8475, 8476, 8477, 8478, 8479, 8480, 8481, 8482, 8483, 8484, 8485, 8486, 8487, 8488, 8489, 8490, 8491, 8492, 8493, 8494, 8495, 8496, 8497, 8498, 8499, 8500, 8501, 8502, 8503, 8504, 8505, 8506, 8507, 8508, 8509, 8510, 8511, 8512, 8513, 8514, 8515, 8516, 8517, 8518, 8519, 8520, 8521, 8522, 8523, 8524, 8525, 8526, 8527, 8528, 8529, 8530, 8531, 8532, 8533, 8534, 8535, 8536, 8537, 8538, 8539, 8540, 8541, 8542, 8543, 8544, 8545, 8546, 8547, 8548, 8549, 8550, 8551, 8552, 8553, 8554, 8555, 8556, 8557, 8558, 8559, 8560, 8561, 8562, 8563, 8564, 8565, 8566, 8567, 8568, 8569, 8570, 8571, 8572, 8573, 8574, 8575, 8576, 8577, 8578, 8579, 8580, 8581, 8582, 8583, 8584, 8585, 8586, 8587, 8588, 8589, 8590, 8591, 8592, 8593, 8594, 8595, 8596, 8597, 8598, 8599, 8600, 8601, 8602, 8603, 8604, 8605, 8606, 8607, 8608, 8609, 8610, 8611, 8612, 8613, 8614, 8615, 8616, 8617, 8618, 8619, 8620, 8621, 8622, 8623, 8624, 8625, 8626, 8627, 8628, 8629, 8630, 8631, 8632, 8633, 8634, 8635, 8636, 8637, 8638, 8639, 8640, 8641, 8642, 8643, 8644, 8645, 8646, 8647, 8648, 8649, 8650, 8651, 8652, 8653, 8654, 8655, 8656, 8657, 8658, 8659, 8660, 8661, 8662, 8663, 8664, 8665, 8666, 8667, 8668, 8669, 8670, 8671, 8672, 8673, 8674, 8675, 8676, 8677, 8678, 8679, 8680, 8681, 8682, 8683, 8684, 8685, 8686, 8687, 8688, 8689, 8690, 8691, 8692, 8693, 8694, 8695, 8696, 8697, 8698, 8699, 8700, 8701, 8702, 8703, 8704, 8705, 8706, 8707, 8708, 8709, 8710, 8711, 8712, 8713, 8714, 8715, 8716, 8717, 8718, 8719, 8720, 8721, 8722, 8723, 8724, 8725, 8726, 8727, 8728, 8729, 8730, 8731, 8732, 8733, 8734, 8735, 8736, 8737, 8738, 8739, 8740, 8741, 8742, 8743, 8744, 8745, 8746, 8747, 8748, 8749, 8750, 8751, 8752, 8753, 8754, 8755, 8756, 8757, 8758, 8759, 8760, 8761, 8762, 8763, 8764, 8765, 8766, 8767, 8768, 8769, 8770, 8771, 8772, 8773, 8774, 8775, 8776, 8777, 8778, 8779, 8780, 8781, 8782, 8783, 8784, 8785, 8786, 8787, 8788, 8789, 8790, 8791, 8792, 8793, 8794, 8795, 8796, 8797, 8798, 8799, 8800, 8801, 8802, 8803, 8804, 8805, 8806, 8807, 8808, 8809, 8810, 8811, 8812, 8813, 8814, 8815, 8816, 8817, 8818, 8819, 8820, 8821, 8822, 8823, 8824, 8825, 8826, 8827, 8828, 8829, 8830, 8831, 8832, 8833, 8834, 8835, 8836, 8837, 8838, 8839, 8840, 8841, 8842, 8843, 8844, 8845, 8846, 8847, 8848, 8849, 8850, 8851, 8852, 8853, 8854, 8855, 8856, 8857, 8858, 8859, 8860, 8861, 8862, 8863, 8864, 8865, 8866, 8867, 8868, 8869, 8870, 8871, 8872, 8873, 8874, 8875, 8876, 8877, 8878, 8879, 8880, 8881, 8882, 8883, 8884, 8885, 8886, 8887, 8888, 8889, 8890, 8891, 8892, 8893, 8894, 8895, 8896, 8897, 8898, 8899, 8900, 8901, 8902, 8903, 8904, 8905, 8906, 8907, 8908, 8909, 8910, 8911, 8912, 8913, 8914, 8915, 8916, 8917, 8918, 8919, 8920, 8921, 8922, 8923, 8924, 8925, 8926, 8927, 8928, 8929, 8930, 8931, 8932, 8933, 8934, 8935, 8936, 8937, 8938, 8939, 8940, 8941, 8942, 8943, 8944, 8945, 8946, 8947, 8948, 8949, 8950, 8951, 8952, 8953, 8954, 8955, 8956, 8957, 8958, 8959, 8960, 8961, 8962, 8963, 8964, 8965, 8966, 8967, 8968, 8969, 8970, 8971, 8972, 8973, 8974, 8975, 8976, 8977, 8978, 8979, 8980, 8981, 8982, 8983, 8984, 8985, 8986, 8987, 8988, 8989, 8990, 8991, 8992, 8993, 8994, 8995, 8996, 8997, 8998, 8999, 9000.

ATTENTION ELF OWNERS: QUEST SUPER BASIC

Quest, the leader in inexpensive 1802 systems announces another first: Quest is the first company worldwide to ship a full size Basic for 1802 systems. A complete function Super Basic by Ron Center including floating point capability with scientific notation (number range  $\pm 1.7E^{99}$ ), 32 bit integer  $\pm 2$  billion, Multi dim arrays, String arrays, String manipulation, Cassette I/O, Save and load, Basic, Data and machine language programs and over 75 Statements, Functions and Operators.

Easily adaptable on most 1802 systems. Requires 12K RAM minimum for Basic and user Programs. Cassette version in stock now. ROM

versions coming soon with exchange privilege allowing some credit for cassette version.

Super Basic on Cassette \$49.00

Tom Pittman's 1802 Tiny Basic Source listing now available. Find out how Tom Pittman wrote Tiny Basic and how to get the most out of it. Never offered before. \$19.00

S-100 Slot Expansion \$9.95

Coming Soon: Assembler and Editor; ROM II Assembler Board. High resolution alpha/numerics with color graphics expandable up to 256 X 192 resolution for less than \$100.

16K Dynam. RAM b/c. expand 32K less than \$150.

RCA Cosmac Super Elf Computer \$106.95

Compare features before you decide to buy any other computer. There is no other computer on the market today that has all the desirable benefits of the Super Elf for so little money. The Super Elf is a small single board computer that does many big things. It is an excellent computer for training and for learning programming with its machine language and yet it is easily expanded with additional memory. Full Basic, ASCII Keyboards, video character generator, etc.

Before you buy another small computer, see if it includes the following features: ROM monitor. State and Mode displays. Single step. Optional address displays. Power Supply. Audio Amplifier and Speaker. Fully socketed for all IC's. Real cost of in warranty repairs. Full documentation.

A 24 key HEX keyboard includes 16 HEX keys plus load, reset, run, wait, input, memory protect, monitor select and single step. Large on board displays provide output and optional high and low address. There is a 44 pin standard connector slot for PC cards and a 50 pin connector slot for the Quest Super Expansion Board. Power supply and sockets for all IC's are included in the price plus a detailed 127 pg. instruction manual which now includes over 40 pgs. of software info. including a series of lessons to help get you started and a music program and graphics target game.

Many schools and universities are using the Super Elf as a course of study. OEM's use it for training and research and development.

Remember, other computers only offer Super Elf features at additional cost or not at all. Compare before you buy. Super Elf kit \$106.95. High address option \$9.95. Low address option \$9.95. Custom Cabinet with drilled and labelled Plexiglass front panel \$24.95. Expansion Cabinet with room for 6 S-100 boards \$41.00. NICAD Battery Memory Saver Kit \$8.95. All kits and options also completely assembled and tested.

Questdata, a 12 page monthly software publication for 1802 computer users is available by subscription for \$12.00 per year.

Tiny Basic Cassette \$10.00. or ROM \$38.00. original Elf kit \$14.95. 1802 software: Mowies Video Graphics \$3.50. Games and Music \$3.00. Chip & Interpreter \$5.50.

Super Expansion Board with Cassette Interface \$89.95

This is truly an astounding value! This board has been designed to allow you to decide how you want it optioned. The Super Expansion Board comes with 4K of low power RAM fully addressable anywhere in 64K with built-in memory protect and a cassette interface. Provisions have been made for as other options on the same board and fits neatly into the hardwood cabinet alongside the Super Elf. The board includes slots for up to 8K of EPROM (2708, 2788, 2716 or 2716) and is fully socketed. EPROM can be used for the monitor and Tiny Basic or other purposes.

subroutines allowing users to take advantage of monitor functions simply by coding them up. Improvements and revisions are easy done with the monitor. If you have the Super Expansion Board and Super Monitor the monitor is up and running at the push of a button.

Other on board options include Parallel Input and Output Ports with full handshake. They allow easy connection of an ASCII keyboard to the input port. RS 232 and 20 ma Current Loop for teletype or other device are on board and if you need more memory there are two S-100 slots for static RAM or video boards. Also a 1K Super Monitor version 2 with video driver for full capability display with Tiny Basic and a video interface board. Parallel I/O Ports \$9.95. RS 232 \$4.50. TTY 20 ma I/O \$1.95. S-100 \$4.00. A 50 pin connector set with ribbon cable is available at \$12.50 for easy connection between the Super Elf and the Super Expansion Board.

Power Supply Kit for the complete system (see Multi-volt Power Supply below).

Multi-volt Computer Power Supply

By 5 amp, -10v 5 amp, 5v 1.5 amp, -5v .5 amp, 12v 5 amp, -12v option  $\pm 5v$ ,  $\pm 12v$  are required. Kit \$29.95. Kit with punched frame \$37.45. \$4.00 shipping. Woodgrain case \$10.00. \$1.50 shipping.

60 Hz Crystal Time Base Kit \$4.40

Converts digital clocks from AC line frequency to crystal time base. Outstanding accuracy. Kit includes PC board, IC, crystal, resistors, capacitors and trimmer.

Rockwell AIM 65 Computer

6502 based single board with full ASCII keyboard and 20 column thermal Printer. 20 char. alphanumeric display, ROM monitor, fully expandable. \$375.00. 4K version \$450.00. 4K Assembler \$85.00. 8K Basic Interpreter \$100.00. Power supply assy. in case \$60.00. AIM 65 in this briefcase with power supply \$495.00.

Auto Clock Kit \$17.95

DC clock with 4-50' displays. Uses National MA-1012 module with alarm option. Includes light dimmer, crystal, timebase PC boards. Fully regulated, comp. instructions. Add \$3.95 for beautiful dark gray case. Best value anywhere.

No1 a Cheap Clock Kit \$14.95

Includes everything except case. 2-PC boards. 8-50' LED Displays. 5314 clock chip, Transformer, all components and full instructions. Orange displays also avail. Same kit w/ 80' displays. Red only. \$21.85 Case \$11.75.

Stopwatch Kit \$26.95

Full six digit battery operated. 2-5 volts. 3.2768 MHz crystal accuracy. Times to 59 min., 59 sec., 99.9/100 sec. Times std., split and Taylor. 7205 chip, all components, minus case. Full instructions.

Video Modulator Kit \$8.95

Convert your TV set into a high quality monitor without affecting normal usage. Complete kit with full instructions.

NiCad Battery Fixer/Charger Kit

Opens shorted cells that won't hold a charge and then charges them up. Kit in one kit w/ full parts and instructions. \$7.25

S-100 Computer Boards

- 8K Static RAM Kit Godbout \$135.00
16K Static RAM Kit 265.00
24K Static RAM Kit 423.00
32K Dynamic RAM Kit 310.00
32K Static RAM Kit \$475.00
64K Dynamic RAM Kit 470.00
8K/16K Eprom Kit (less PROMS) \$89.00
Video Interface Kit \$139.00
Motherboard \$39. Extender Board \$8.99

PRDM Eraser

Will erase 25 PROMS in 15 minutes. Ultra-violet, assembled. \$34.50

79 IC Update Master Manual \$35.00

Complete IC data selector. 2500 pg. master reference guide. Over 50,000 cross references. Free update service through 1979. Domestic postage \$3.50. No foreign orders.

Hickok 3 1/2 Digit LCD Multimeter

Batu AC opt. 0.1mv-1000v. 5 ranges. 0.5% accur. Resistance 8 low power ranges 0.1 ohm-20M ohm. DC curr. .01 to 100ma. Hand held. 1/2" LCD displays. auto zero. polarity, over-range. \$69.95

Digital Temp. Meter Kit \$34.00

Indoor and outdoor. Switches back and forth. Beautiful, 50' LED readouts. Nothing like it available. Needs no additional parts for complete, full operation. Will measure  $-100^{\circ}$  to  $+200^{\circ}$ F. tenths of a degree. air or liquid. Beautiful woodgrain case w/bazel \$11.75

TERMS: \$5.00 min. order U.S. Funds. Call residents add 6% tax. BankAmericard and Master Charge accepted. Shipping charges will be added on charge cards.

FREE: Send for your copy of our NEW 1979 QUEST CATALOG. Include 28c stamp.





### Continuity Tester and Flashlight

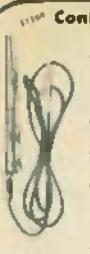

Convenient versatile tool for quickly checking continuity of dead circuits, switches, appliances, cords, fuses, motors, control equipment, coils and panel boards. Also tests circuits for low-resistance shorts and helps identify wires in multi-wire cables. Dozens of other uses. Plus the added convenience of a handy, durable flashlight. Uses two AA size penlight batteries (not furnished). Insulated clip prevents accidental shorting to case. Alligator clip has 48" lead with plug.

**RT300 \$7.95**

### Custom Cables & Jumpers

**DB 25 Series Cables**

Part No.	Cable Length	Connectors	Price
DB25P-4P	4 ft.	2 DB25P	\$15.95 ea
DB25P-4S	4 ft.	1-DB25P/1-25S	\$16.95 ea
DB25S-4S	4 ft.	2 DB25S	\$17.95 ea

**Dip Jumpers**

QJ1-1	1 ft.	1-14 Pin	\$1.50 ea
QJ1-1	1 ft.	1-16 Pin	1.75 ea
QJ2-1	1 ft.	1-24 Pin	2.75 ea
QJ1-1-14	1 ft.	2-14 Pin	2.75 ea
QJ1B-1-16	1 ft.	2-16 Pin	3.19 ea
QJ2-1-24	1 ft.	2-24 Pin	4.95 ea

For Custom Cables & Jumpers, See JAMECO 1980 Catalog for Pricing

### 30 PIN-D SUBMINIATURE CONNECTORS

(Meets RS232C)

CABLE NO.	DESCRIPTION	PRICE
DB25P	PLUG (as pictured)	\$2.95
DB25M	SOCKET	3.50
DB51-224-1	CABLE COVER for DB25P or DB25M	1.75
DB25P-331	PLUG - Right Angle - P.C. Mount	4.95
DB25S-431	SOCKET - Right Angle - P.C. Mount	5.75

### Printed Circuit Connectors

100 Spacing - The Double Row Out

Plated Contacts  
Fits 154 to 676 P.C. Boards

PART NO.	DESCRIPTION	PRICE
18/28 SE	15/20 Contacts - solder w/lead	\$1.75
18/28 SE	18/25 Contacts - solder w/lead	2.68
22/44 SE	22/44 Contacts - solder w/lead	2.68
22/44 WH	22/44 Contacts - wire w/lead	3.00
50/100 WH	50/100 Contacts - wire w/lead (RS81-1) (125 Spacing)	6.95

### Jumbo 6-Digit Clock Kit

- Four 800Hz and two 300Hz common anode displays
- Uses 555MHz clock chip
- Switches for hours, minutes and hold functions
- Hours display viewable to 20 feet
- Simulation - about case
- 115VAC operation
- 12 00 24 hour operation
- Includes all components, case and wall transformer
- Size: 3 1/2" x 5 1/2" x 1 1/2"

**JE747 \$29.95**

### JE701

- Bright 300 Hz. common anode display
- Uses 555MHz clock chip
- Switches for hours, minutes and hold modes
- Hours display viewable to 20 ft.
- Simulated vacuum case
- 115 VAC operation
- 12 or 24 hr. operation
- Incl. all components, case & wall transformer
- Size: 5 1/2" x 3 1/2" x 1 1/2"

**6-Digit Clock Kit \$19.95**

### Regulated Power Supply

Uses LM309K. Heat sink provided. PC board construction. Provides a solid 1 amp @ 5 volts. Can supply up to +5V, +9V and +12V with JE205 Adapter. Includes components, hardware and instructions. Size: 3 3/4" x 5" x 2 1/4"

**JE200 \$14.95**

### ADAPTER BOARD

-Adapts to JE200-  
+5V, +9V and +12V

DC/DC converter with +5V input. Toroidal hi-speed switching XaFR. Short circuit protection. PC board construction. Plug-back to JE 200 board. Size: 3 3/4" x 2" x 9/16"

**JE205 \$12.95**

### MICROPROCESSOR COMPONENTS

JAMECO SUPPORT DEVICES		MICROPROCESSOR MANUALS	
8028A	CPU	\$ 5.95	87.90
8212	16 Bit Input Output	3.25	7.50
8214	Priority Interrupt Controller	8.95	15.00
8216	16 Channel Bus Driver	3.19	
8234	Cache Memory Strap	3.95	
8226	Bus Driver	3.44	
8228	System Controller Bus Driver	4.95	
8228	System Controller	5.95	
8251	Prog. Counter 1.0 (ROM)	7.95	
8253	Prog. Interval Timer	14.95	
8255	Prog. I/O Exp. (I/O)	9.95	
8257	Prog. DMA Controller	19.95	
8258	Prog. Interval Support	19.95	

JAMECO SUPPORT DEVICES		MICROPROCESSOR MANUALS	
MC6800	16-bit 8000 Support Device	114.00	
MC6802	16-bit 8000 Support Device	24.95	
MC6803	16-bit 8000 Support Device	8.95	
MC6804	16-bit 8000 Support Device	21.95	
MC6805	16-bit 8000 Support Device	11.95	
MC6806	16-bit 8000 Support Device	11.95	
MC6807	16-bit 8000 Support Device	11.95	
MC6808	16-bit 8000 Support Device	11.95	
MC6809	16-bit 8000 Support Device	11.95	
MC6810	16-bit 8000 Support Device	11.95	
MC6811	16-bit 8000 Support Device	11.95	
MC6812	16-bit 8000 Support Device	11.95	
MC6813	16-bit 8000 Support Device	11.95	
MC6814	16-bit 8000 Support Device	11.95	
MC6815	16-bit 8000 Support Device	11.95	
MC6816	16-bit 8000 Support Device	11.95	
MC6817	16-bit 8000 Support Device	11.95	
MC6818	16-bit 8000 Support Device	11.95	
MC6819	16-bit 8000 Support Device	11.95	
MC6820	16-bit 8000 Support Device	11.95	
MC6821	16-bit 8000 Support Device	11.95	
MC6822	16-bit 8000 Support Device	11.95	
MC6823	16-bit 8000 Support Device	11.95	
MC6824	16-bit 8000 Support Device	11.95	
MC6825	16-bit 8000 Support Device	11.95	
MC6826	16-bit 8000 Support Device	11.95	
MC6827	16-bit 8000 Support Device	11.95	
MC6828	16-bit 8000 Support Device	11.95	
MC6829	16-bit 8000 Support Device	11.95	
MC6830	16-bit 8000 Support Device	11.95	
MC6831	16-bit 8000 Support Device	11.95	
MC6832	16-bit 8000 Support Device	11.95	
MC6833	16-bit 8000 Support Device	11.95	
MC6834	16-bit 8000 Support Device	11.95	
MC6835	16-bit 8000 Support Device	11.95	
MC6836	16-bit 8000 Support Device	11.95	
MC6837	16-bit 8000 Support Device	11.95	
MC6838	16-bit 8000 Support Device	11.95	
MC6839	16-bit 8000 Support Device	11.95	
MC6840	16-bit 8000 Support Device	11.95	
MC6841	16-bit 8000 Support Device	11.95	
MC6842	16-bit 8000 Support Device	11.95	
MC6843	16-bit 8000 Support Device	11.95	
MC6844	16-bit 8000 Support Device	11.95	
MC6845	16-bit 8000 Support Device	11.95	
MC6846	16-bit 8000 Support Device	11.95	
MC6847	16-bit 8000 Support Device	11.95	
MC6848	16-bit 8000 Support Device	11.95	
MC6849	16-bit 8000 Support Device	11.95	
MC6850	16-bit 8000 Support Device	11.95	
MC6851	16-bit 8000 Support Device	11.95	
MC6852	16-bit 8000 Support Device	11.95	
MC6853	16-bit 8000 Support Device	11.95	
MC6854	16-bit 8000 Support Device	11.95	
MC6855	16-bit 8000 Support Device	11.95	
MC6856	16-bit 8000 Support Device	11.95	
MC6857	16-bit 8000 Support Device	11.95	
MC6858	16-bit 8000 Support Device	11.95	
MC6859	16-bit 8000 Support Device	11.95	
MC6860	16-bit 8000 Support Device	11.95	
MC6861	16-bit 8000 Support Device	11.95	
MC6862	16-bit 8000 Support Device	11.95	
MC6863	16-bit 8000 Support Device	11.95	
MC6864	16-bit 8000 Support Device	11.95	
MC6865	16-bit 8000 Support Device	11.95	
MC6866	16-bit 8000 Support Device	11.95	
MC6867	16-bit 8000 Support Device	11.95	
MC6868	16-bit 8000 Support Device	11.95	
MC6869	16-bit 8000 Support Device	11.95	
MC6870	16-bit 8000 Support Device	11.95	
MC6871	16-bit 8000 Support Device	11.95	
MC6872	16-bit 8000 Support Device	11.95	
MC6873	16-bit 8000 Support Device	11.95	
MC6874	16-bit 8000 Support Device	11.95	
MC6875	16-bit 8000 Support Device	11.95	
MC6876	16-bit 8000 Support Device	11.95	
MC6877	16-bit 8000 Support Device	11.95	
MC6878	16-bit 8000 Support Device	11.95	
MC6879	16-bit 8000 Support Device	11.95	
MC6880	16-bit 8000 Support Device	11.95	
MC6881	16-bit 8000 Support Device	11.95	
MC6882	16-bit 8000 Support Device	11.95	
MC6883	16-bit 8000 Support Device	11.95	
MC6884	16-bit 8000 Support Device	11.95	
MC6885	16-bit 8000 Support Device	11.95	
MC6886	16-bit 8000 Support Device	11.95	
MC6887	16-bit 8000 Support Device	11.95	
MC6888	16-bit 8000 Support Device	11.95	
MC6889	16-bit 8000 Support Device	11.95	
MC6890	16-bit 8000 Support Device	11.95	
MC6891	16-bit 8000 Support Device	11.95	
MC6892	16-bit 8000 Support Device	11.95	
MC6893	16-bit 8000 Support Device	11.95	
MC6894	16-bit 8000 Support Device	11.95	
MC6895	16-bit 8000 Support Device	11.95	
MC6896	16-bit 8000 Support Device	11.95	
MC6897	16-bit 8000 Support Device	11.95	
MC6898	16-bit 8000 Support Device	11.95	
MC6899	16-bit 8000 Support Device	11.95	
MC6900	16-bit 8000 Support Device	11.95	
MC6901	16-bit 8000 Support Device	11.95	
MC6902	16-bit 8000 Support Device	11.95	
MC6903	16-bit 8000 Support Device	11.95	
MC6904	16-bit 8000 Support Device	11.95	
MC6905	16-bit 8000 Support Device	11.95	
MC6906	16-bit 8000 Support Device	11.95	
MC6907	16-bit 8000 Support Device	11.95	
MC6908	16-bit 8000 Support Device	11.95	
MC6909	16-bit 8000 Support Device	11.95	
MC6910	16-bit 8000 Support Device	11.95	
MC6911	16-bit 8000 Support Device	11.95	
MC6912	16-bit 8000 Support Device	11.95	
MC6913	16-bit 8000 Support Device	11.95	
MC6914	16-bit 8000 Support Device	11.95	
MC6915	16-bit 8000 Support Device	11.95	
MC6916	16-bit 8000 Support Device	11.95	
MC6917	16-bit 8000 Support Device	11.95	
MC6918	16-bit 8000 Support Device	11.95	
MC6919	16-bit 8000 Support Device	11.95	
MC6920	16-bit 8000 Support Device	11.95	
MC6921	16-bit 8000 Support Device	11.95	
MC6922	16-bit 8000 Support Device	11.95	
MC6923	16-bit 8000 Support Device	11.95	
MC6924	16-bit 8000 Support Device	11.95	
MC6925	16-bit 8000 Support Device	11.95	
MC6926	16-bit 8000 Support Device	11.95	
MC6927	16-bit 8000 Support Device	11.95	
MC6928	16-bit 8000 Support Device	11.95	
MC6929	16-bit 8000 Support Device	11.95	
MC6930	16-bit 8000 Support Device	11.95	
MC6931	16-bit 8000 Support Device	11.95	
MC6932	16-bit 8000 Support Device	11.95	
MC6933	16-bit 8000 Support Device	11.95	
MC6934	16-bit 8000 Support Device	11.95	
MC6935	16-bit 8000 Support Device	11.95	
MC6936	16-bit 8000 Support Device	11.95	
MC6937	16-bit 8000 Support Device	11.95	
MC6938	16-bit 8000 Support Device	11.95	
MC6939	16-bit 8000 Support Device	11.95	
MC6940	16-bit 8000 Support Device	11.95	
MC6941	16-bit 8000 Support Device	11.95	
MC6942	16-bit 8000 Support Device	11.95	
MC6943	16-bit 8000 Support Device	11.95	
MC6944	16-bit 8000 Support Device	11.95	
MC6945	16-bit 8000 Support Device	11.95	
MC6946	16-bit 8000 Support Device	11.95	
MC6947	16-bit 8000 Support Device	11.95	
MC6948	16-bit 8000 Support Device	11.95	
MC6949	16-bit 8000 Support Device	11.95	
MC6950	16-bit 8000 Support Device	11.95	
MC6951	16-bit 8000 Support Device	11.95	
MC6952	16-bit 8000 Support Device	11.95	
MC6953	16-bit 8000 Support Device	11.95	
MC6954	16-bit 8000 Support Device	11.95	
MC6955	16-bit 8000 Support Device	11.95	
MC6956	16-bit 8000 Support Device	11.95	
MC6957	16-bit 8000 Support Device	11.95	
MC6958	16-bit 8000 Support Device	11.95	
MC6959	16-bit 8000 Support Device	11.95	
MC6960	16-bit 8000 Support Device	11.95	
MC6961	16-bit 8000 Support Device	11.95	
MC6962	16-bit 8000 Support Device	11.95	
MC6963	16-bit 8000 Support Device	11.95	
MC6964	16-bit 8000 Support Device	11.95	
MC6965	16-bit 8000 Support Device	11.95	
MC6966	16-bit 8000 Support Device	11.95	
MC6967	16-bit 8000 Support Device	11.95	
MC6968	16-bit 8000 Support Device	11.95	
MC6969	16-bit 8000 Support Device	11.95	
MC6970	16-bit 8000 Support Device	11.95	
MC6971	16-bit 8000 Support Device	11.95	
MC6972	16-bit 8000 Support Device	11.95	
MC6973	16-bit 8000 Support Device	11.95	
MC6974	16-bit 8000 Support Device	11.95	
MC6975	16-bit 8000 Support Device	11.95	
MC6976	16-bit 8000 Support Device	11.95	
MC6977	16-bit 8000 Support Device	11.95	
MC6978	16-bit 8000 Support Device	11.95	
MC6979	16-bit 8000 Support Device	11.95	
MC6980	16-bit 8000 Support Device	11.95	
MC6981	16-bit 8000 Support Device	11.95	
MC6982	16-bit 8000 Support Device	11.95	
MC6983	16-bit 8000 Support Device	11.95	
MC6984	16-bit 8000 Support Device	11.95	
MC6985	16-bit 8000 Support Device	11.95	
MC6986	16-bit 8000 Support Device	11.95	
MC6987	16-bit 8000 Support Device	11.95	







# Radio Shack — Your No. 1 Parts Place™

## Low Prices and New Items Every Day!

### Low-Power Schottky ICs

Low As **49¢**

- 100% Prime
- Guaranteed Specs

Improved 5-volt logic devices use Schottky diode technology for minimum propagation delay and high speed at minimum power.

Type	Cat. No.	ONLY
74LS00	276-1900	.49
74LS02	276-1902	.59
74LS04	276-1904	.59
74LS08	276-1906	.49
74LS10	276-1910	.59
74LS13	276-1911	.99
74LS20	276-1912	.59
74LS27	276-1913	.99
74LS30	276-1914	.59
74LS32	276-1915	.99
74LS47	276-1916	1.29
74LS51	276-1917	.59
74LS73	276-1918	.99
74LS74	276-1919	.99
74LS75	276-1920	.99
74LS76	276-1921	.79
74LS85	276-1922	1.29
74LS90	276-1923	.99
74LS92	276-1924	.99
74LS93	276-1925	.99
74LS123	276-1926	1.19
74LS132	276-1927	.99
74LS151	276-1929	.99
74LS157	276-1930	1.19
74LS161	276-1931	1.49
74LS164	276-1932	1.49
74LS175	276-1934	1.19
74LS192	276-1935	1.49
74LS193	276-1936	1.49
74LS194	276-1937	1.49
74LS196	276-1938	1.59
74LS367	276-1935	1.19
74LS368	276-1936	1.19
74LS373	276-1943	2.39
74LS374	276-1944	2.39

### 4000-Series CMOS ICs

Type	Cat. No.	EACH
4001	276-2401	.99
4011	276-2411	.99
4012	276-2412	.79
4013	276-2413	.99
4017	276-2417	1.99
4020	276-2420	1.99
4021	276-2421	1.99
4023	276-2423	.99
4027	276-2427	.99
4028	276-2428	1.29
4046	276-2446	1.99
4511	276-2447	1.99
4049	276-2449	.79
4050	276-2450	.79
4051	276-2451	1.49
4056	276-2456	1.39
4070	276-2470	.79
4518	276-2480	1.49
4543	276-2491	1.99

All Prime from Major Semiconductor Manufacturers. Specs and Pin Out Diagram Included with Each Device.

### MC14553 3-Digit BCD Counter IC **2<sup>99</sup>**

CMOS chip replaces over 8 separate ICs in a digital display circuit. Input pulse shaping. Master reset pin. 16-pin DIP. 276-2498 ..... 2.99

### RAM Memory ICs **2<sup>49</sup>**

Low As **2<sup>49</sup>**

2102 1024 x 8 Array. Low-cost static memory chip. 16-pin DIP. Buy 8 and save! 276-2801 ..... 2.99 Ea. or 8-14.95  
2114L 1024 x 4 Array. NMOS static RAM. 16-pin DIP. 276-2804 ..... 10.99

### NEW! Rectangular LED Lamps



**99¢**  
Pkg. of 2

High-brightness. Can be stacked vertically or horizontally. Max. forward current: 30 mA. Typical forward voltage: 2.5.  
276-076, Red ..... 2.99¢  
276-071, Green ..... 2.99¢  
276-072, Yellow ..... 2.99¢

### NEW! Pair of LED Digits

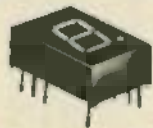

**1<sup>98</sup>**

These 10mm 7-segment, red displays are ideal low-cost readouts for any projects. For multiplexed or direct drive. Max. forward current: 45mA/segment.  
Common Anode: 276-1643 ..... 2/1.98  
Common Cathode: 276-1644 ..... 2/1.98

### NEW! Oscillator/Divider IC



**2<sup>69</sup>**

CMOS IC with 17 binary divider stages produces a highly stable 60 Hz square wave. Uses a TV 3.58 MHz crystal reference. Very low power operation over wide 3-15VDC range. 8-pin DIP.  
276-1789 ..... 2.99  
3.58 MHz Crystal ..... 2.99

### LED Bar/Dot Display Driver

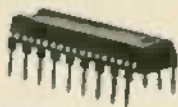

**3<sup>49</sup>**

LM3914N. Features 10 adjustable analog steps, bar or dot display mode. Current-regulated LED outputs. 8 to 25VDC supply. 18-pin DIP. 276-1707 ..... 3.49  
LM3915N. As above but with 3 dB log steps. 276-1708 ..... 3.49

### NEW! Silicon Solar Cells

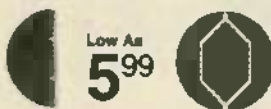

Low As **5<sup>99</sup>**

High Efficiency

Convert light to electrical power. All deliver 0.45V at rated current. Use several in series/parallel for higher voltages or current.  
276-122, 1/2" cell. Rated 500 mA ..... 5.99  
276-123, Full 3" cell. Rated 1 amp ..... 8.99

### Hall-Effect Sensors



**1<sup>98</sup>** Pkg. of 3

Open-Collector Output

Detects magnetic fields electronically. 750 gauss "on" threshold. Constant amplitude independent of frequency. Similar to type ULN 3006. Ideal for tach, position sensing, pulse counting. 5 to 16V supply. TO-92 case. With data.  
276-1645 ..... Pkg. of 3/1.98

### Unique LEDs



Tri-Color. Displays red, green, yellow. Uniform light output of 0.8 mcd. Forward voltage: 2.2VDC. Max. current: 25mA. T1-1/2 case style. 276-039 ..... 1.39

Red Flasher. Operates directly from 5VDC power source. Pulse rate: 3 Hz. Max. current: 20 mA at 5VDC. 276-038 ..... 1.29

### 10 Assorted Mini Reed Switches

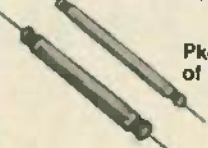

Pkg. of 10 **1<sup>98</sup>**

Hermetically sealed. Gold-plated contacts close when magnetic field is present. Includes mini and micro types. 276-1810 ..... Pkg. of 10/1.98

### Permanent Magnet Motors



**99¢** Pkg. of 2

Up to 10,000 RPM at no load. Long leads for easy hook-up. Motor is 1 1/2" x 1/2". Shaft, 3/16" x 1/4". 273-206 ..... 2.99¢

### 12/24-Hr. LCD Clock Module

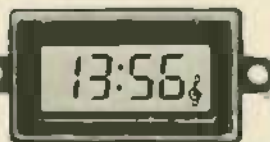

**19<sup>95</sup>**

Actual Size

### 24-Hour Alarm Shows Time/Day/Date

Complete clock module — just add switches and battery! 0.25" LCD display has built-in backlight, alarm set, PM and snooze indicators. Operates up to a year on single 1.5V battery. Accuracy: ±13 seconds per month. 277-1005 ..... 19.95

### Top Octave Synthesizer IC

NEW! **6<sup>99</sup>**

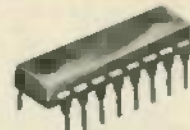

S50240. CMOS oscillator/frequency divider chip generates 13 equal-tempered notes from C<sub>4</sub> to C<sub>6</sub> to form the heart of any electronic keyboard instrument. CMOS compatible square wave outputs have 50% duty cycle for driving additional dividers or voice filters. Operates from single supply from 11 to 16 volts. 16-pin DIP. 276-1788 ..... 8.99

### RAM Memory ICs **2<sup>49</sup>**

2102 1024 x 8 Array. Low-cost static memory chip. 16-pin DIP. Buy 8 and save! 276-2801 ..... 2.99 Ea. or 8-14.95  
2114L 1024 x 4 Array. NMOS static RAM. 16-pin DIP. 276-2804 ..... 10.99

### 4" Cooling Fan



**12<sup>95</sup>**

Super Quiet Operation

Ideal for cooling power supplies, microcomputers, hi-fi and ham gear. Delivers up to 70 CFM. Diecast venturi. U.L. recognized motor. For 120VAC, 60 Hz. 273-241 ..... 12.95

### Dual Analog Delay IC

**10<sup>95</sup>**

Continuously Variable — Many Audio Applications



SAD1824A. "Bucket Brigade" device has 2 separate 512-stage shift registers which can be used independently or in combination. Provides continuously variable electronic delay for complex audio signals to create reverb, echo, phase shift, chorus and vibrato effects. Reliable NMOS design operates from single supply. With applications circuits and data. 16-pin DIP. 276-1761 ..... 10.95

WHY WAIT FOR MAIL ORDER DELIVERY?  
IN STOCK NOW AT OUR STORE NEAR YOU!

# Radio Shack®

A DIVISION OF TANDY CORPORATION • FORT WORTH, TEXAS 76102  
OVER 7000 LOCATIONS IN 49 COUNTRIES

Prices may vary at individual stores and dealers

CIRCLE 17 ON FREE INFORMATION CARD

JANUARY 1980



AVAILABLE NOW!

ONLY \$3.95  
Add \$1.00 for shipping

JAPANESE TRANSISTOR SUBSTITUTION MANUAL



An invaluable Japanese to Japanese substitution guide for approximately 3000 transistors

- Covers the 7SA, 2SD, 2SC and 2SD units
- Introduction includes a guide to understanding Japanese transistors
- A 90 page 8 1/2 by 11 inch cover book

# PARTS PROCUREMENT PROBLEMS

## FUJI-SVEA Has the Largest Inventory of Original Japanese Parts Anywhere

### Seeking Original Japanese Replacement Parts for CB, TV and Stereo Repair Use?

TYPE	25	UP	10-24	1-9	TYPE	25	UP	10-24	1-9	TYPE	25	UP	10-24	1-9	TYPE	25	UP	10-24	1-9
2SA 473	45	55	60		2SB 348	30	35	40		2SC 693F	20	27	30		2SD 234	80	70	80	
2SA 480	2.00	2.20	2.50		2SB 367	1.10	1.25	1.40		2SC 696	1.00	1.20	1.30		2SD 235	60	70	80	
2SA 484	1.50	1.75	1.95		2SB 368B	1.80	2.00	2.25		2SC 708	1.30	1.45	1.60		2SD 261	35	40	45	
2SA 485	1.40	1.60	1.80		2SB 378	70	40	90		2SC 710	20	27	30		2SD 287	2.50	2.70	2.90	
2SA 488	1.10	1.25	1.40		2SB 381	30	35	40		2SC 712	20	27	30		2SD 300	4.50	5.00	5.60	
2SA 490	70	40	90		2SB 400	30	35	40		2SC 713	20	27	30		2SD 313	60	70	80	
2SA 493	45	53	59		2SB 405	30	35	40		2SC 715	30	35	40		2SD 315	60	70	80	
2SA 495	30	35	40		2SB 407	10	90	100		2SC 717	35	40	45		2SD 325	80	70	80	
2SA 498	50	64	70		2SB 415	30	35	40		2SC 721	1.80	1.20	1.30		2SD 330	80	70	80	
2SA 497	1.00	1.20	1.30		2SB 434	60	90	100		2SC 730	3.00	1.20	2.40		2SD 350	3.60	4.00	4.40	
2SA 505	50	64	70		2SB 438	90	110	120		2SC 731	2.50	2.70	2.90		2SD 380	5.20	5.40	5.95	
2SA 509	30	35	40		2SB 440	40	53	59		2SC 732	35	40	45		2SD 381	85	1.00	1.10	
2SA 525	50	64	70		2SB 448	1.30	1.45	1.60		2SC 733	20	27	30		2SD 424	1.80	2.00	2.20	
2SA 530	1.50	1.70	1.90		2SB 461	90	1.50	1.20		2SC 734	20	27	30		2SD 425	2.90	3.20	3.40	
2SA 537A	1.50	1.70	1.90		2SB 463	90	1.10	1.20		2SC 735	20	27	30		2SD 426	3.10	3.30	3.60	
2SA 539	40	45	50		2SB 471	1.10	1.25	1.40		2SC 736	70	24	30		2SD 427	1.60	2.00	2.25	
2SA 545	45	53	59		2SB 472	2.50	2.60			2SC 737	1.50	1.80	2.00		2SD 525	90	1.10	1.20	
2SA 541	30	35	40		2SB 473	90	90	100		2SC 738	35	40	45		2SD 526	60	70	80	
2SA 562	30	35	40		2SB 474	90	80	90		2SC 739	35	40	45		2SK 198L	1.50	35	60	
2SA 564A	20	27	30		2SB 475	90	1.10	1.20		2SC 741	30	35	40		3SK 22Y	1.40	1.60	1.90	
2SA 565	70	80	90		2SB 476	60	70	80		2SC 742	35	40	45		3SK 39	90	1.10	1.20	
2SA 566	2.50	2.70	3.00		2SB 477	90	90	100		2SC 744	1.80	1.20	1.30		3SK 40	90	1.10	1.20	
2SA 606	1.00	1.20	1.30		2SB 509	40	1.10	1.20		2SC 745	1.40	1.60	1.80		3SK 41	1.30	1.45	1.60	
2SA 607	1.10	1.25	1.40		2SB 511	70	80	90		2SC 746	2.00	2.20	2.40		3SK 45	1.30	1.45	1.60	
2SA 624	70	80	90		2SB 514	70	80	90		2SC 747	3.00	3.25	3.50		AN 313	3.00	2.20	2.50	
2SA 627	3.10	3.30	3.60		2SB 523	70	80	90		2SC 748	2.50	3.25	3.50		AN 315	1.80	2.00	2.25	
2SA 628	30	35	40		2SB 526C	70	80	90		2SC 749	2.00	2.20	2.40		AN 319	4.20	4.40	4.90	
2SA 634	40	45	50		2SB 527	90	1.10	1.20		2SC 750	80	90	100		AN 347	2.50	2.70	3.00	
2SA 640	30	35	40		2SB 528	70	80	90		2SC 751	1.50	1.70	1.90		AN 374	1.50	1.75	1.95	
2SA 642	30	35	40		2SB 529	70	80	90		2SC 752	1.50	1.70	1.90		AN 375	3.00	3.20	3.40	
2SA 643	30	40	45		2SB 530	3.5	2.40	1.70		2SC 753	2.00	3.25	3.50		AN 376	1.80	2.00	2.25	
2SA 653	1.90	2.10	2.40		2SB 531	1.40	1.60	2.25		2SC 754	2.00	2.20	2.40		AN 377	1.50	1.70	1.90	
2SA 659	35	40	45		2SB 532	1.00	1.20	1.30		2SC 755	2.00	2.20	2.50		AN 378	1.50	1.70	1.90	
2SA 661	50	64	70		2SB 533	1.00	1.20	1.30		2SC 756	2.00	2.20	2.50		AN 379	1.50	1.70	1.90	
2SA 663	1.5	2.0	4.20		2SB 534	1.00	1.20	1.30		2SC 757	2.00	2.20	2.50		AN 380	1.50	1.70	1.90	
2SA 664	35	40	45		2SB 535	1.00	1.20	1.30		2SC 758	2.00	2.20	2.50		AN 381	1.50	1.70	1.90	
2SA 671	80	90	100		2SB 536	1.00	1.20	1.30		2SC 759	2.00	2.20	2.50		AN 382	1.50	1.70	1.90	
2SA 672	30	35	40		2SB 537	1.00	1.20	1.30		2SC 760	2.00	2.20	2.50		AN 383	1.50	1.70	1.90	
2SA 673	35	40	45		2SB 538	1.00	1.20	1.30		2SC 761	2.00	2.20	2.50		AN 384	1.50	1.70	1.90	
2SA 678	35	40	45		2SB 539	1.00	1.20	1.30		2SC 762	2.00	2.20	2.50		AN 385	1.50	1.70	1.90	
2SA 679	4.0	4.0	4.90		2SB 540	1.00	1.20	1.30		2SC 763	2.00	2.20	2.50		AN 386	1.50	1.70	1.90	
2SA 680	4.20	4.40	4.90		2SB 541	1.00	1.20	1.30		2SC 764	2.00	2.20	2.50		AN 387	1.50	1.70	1.90	
2SA 682	4.0	4.0	1.00		2SB 542	1.00	1.20	1.30		2SC 765	2.00	2.20	2.50		AN 388	1.50	1.70	1.90	
2SA 683	30	35	40		2SB 543	1.00	1.20	1.30		2SC 766	2.00	2.20	2.50		AN 389	1.50	1.70	1.90	
2SA 684	35	40	45		2SB 544	1.00	1.20	1.30		2SC 767	2.00	2.20	2.50		AN 390	1.50	1.70	1.90	
2SA 695	40	53	59		2SB 545	1.00	1.20	1.30		2SC 768	2.00	2.20	2.50		AN 391	1.50	1.70	1.90	
2SA 697	40	53	59		2SB 546	1.00	1.20	1.30		2SC 769	2.00	2.20	2.50		AN 392	1.50	1.70	1.90	
2SA 699A	50	64	70		2SB 547	1.00	1.20	1.30		2SC 770	2.00	2.20	2.50		AN 393	1.50	1.70	1.90	
2SA 705	40	53	59		2SB 548	1.00	1.20	1.30		2SC 771	2.00	2.20	2.50		AN 394	1.50	1.70	1.90	
2SA 706	85	100	110		2SB 549	1.00	1.20	1.30		2SC 772	2.00	2.20	2.50		AN 395	1.50	1.70	1.90	
2SA 718	80	70	80		2SB 550	1.00	1.20	1.30		2SC 773	2.00	2.20	2.50		AN 396	1.50	1.70	1.90	
2SA 719	30	35	40		2SB 551	1.00	1.20	1.30		2SC 774	2.00	2.20	2.50		AN 397	1.50	1.70	1.90	
2SA 720	30	35	40		2SB 552	1.00	1.20	1.30		2SC 775	2.00	2.20	2.50		AN 398	1.50	1.70	1.90	
2SA 721	30	35	40		2SB 553	1.00	1.20	1.30		2SC 776	2.00	2.20	2.50		AN 399	1.50	1.70	1.90	
2SA 725	30	35	40		2SB 554	1.00	1.20	1.30		2SC 777	2.00	2.20	2.50		AN 400	1.50	1.70	1.90	
2SA 728	30	35	40		2SB 555	1.00	1.20	1.30		2SC 778	2.00	2.20	2.50		AN 401	1.50	1.70	1.90	
2SA 733	20	27	30		2SB 556	1.00	1.20	1.30		2SC 779	2.00	2.20	2.50		AN 402	1.50	1.70	1.90	
2SA 738	40	53	59		2SB 557	1.00	1.20	1.30		2SC 780	2.00	2.20	2.50		AN 403	1.50	1.70	1.90	
2SA 740	1.50	1.70	1.90		2SB 558	1.00	1.20	1.30		2SC 781	2.00	2.20	2.50		AN 404	1.50	1.70	1.90	
2SA 743A	85	100	110		2SB 559	1.00	1.20	1.30		2SC 782	2.00	2.20	2.50		AN 405	1.50	1.70	1.90	
2SA 744	4.20	4.40	4.90		2SB 560	1.00	1.20	1.30		2SC 783	2.00	2.20	2.50		AN 406	1.50	1.70	1.90	
2SA 745A	3.10	4.00	4.40		2SB 561	1.00	1.20	1.30		2SC 784	2.00	2.20	2.50		AN 407	1.50	1.70	1.90	
2SA 747	4.20	4.40	4.90		2SB 562	1.00	1.20	1.30		2SC 785	2.00	2.20	2.50		AN 408	1.50	1.70	1.90	
2SA 748	70	80	90		2SB 563	1.00	1.20	1.30		2SC 786	2.00	2.20	2.50		AN 409	1.50	1.70	1.90	
2SA 750	35	40	45		2SB 564	1.00	1.20	1.30		2SC 787	2.00	2.20	2.50		AN 410	1.50	1.70	1.90	
2SA 755	80	90	100		2SB 565	1.00	1.20	1.30		2SC 788	2.00	2.20	2.50		AN 411	1.50	1.70	1.90	
2SA 756	2.30	2.80	2.85		2SB 566	1.00	1.20	1.30		2SC 789	2.00	2.20	2.50		AN 412	1.50	1.70	1.90	
2SA 758	3.40	3.55	3.90		2SB 567	1.00	1.20	1.30		2SC 790	2.00	2.20	2.50		AN 413	1.50	1.70	1.90	
2SA 764	3.80	4.00	4.40		2SB 568	1.00	1.20	1.30		2SC 791	2.00	2.20	2.50		AN 414	1.50	1.70	1.90	
2SA 765	3.10	3.30	3.60		2SB 569	1.00	1.20	1.30		2SC 792	2.00	2.20	2.50		AN 415	1.50	1.70	1.90	
2SA 774	4.0	4.0	4.90		2SB 570	1.00	1.20	1.30		2SC 793	2.00	2.20	2.50		AN 416	1.50	1.70	1.90	
2SA 777	50	64	70																

# WOW! tv stuff !!!

Come and get 'em — we're closing out items from a major manufacturer on a first come, first served basis. All of the below are limited quantity items and are subject to prior sale. Allow 10 lbs. average shipping weight per cathode-ray tube (CRT).

- 16" COLOR CRT (type 18DAP22) ... \$29.00
- 13" B & W CRT (type 13VADP4A) ... \$10.00
- 19" B & W CRT (type 19DUP4) ... \$16.00  
(Above two items great for TVs, monitors)
- 5" FLYING SPOT SCANNER CRT (type SSC4679BPS; looks like something for hams, experimenters ... \$39.00

**DE-GAUSSING COIL** Please don't ask us what this is; it's only for those who know what it is and how to use it! \$2.50 each or 2/\$4.00

## AND WE ALSO HAVE A SCREAMING SPECIAL ON SOCKETS!

18 pin socket special: Tin solderable, low profile types from a major manufacturer. 20¢/1.85 (less than a dime apiece... when do you think you'll see them at that price again?) Limited quantity.

TERMS: VISA/Mastercharge® call our 24 hour order desk at (415) 542-9656. Cal res add tax. COD OK with street address for UPS. Allow 5% for shipping, excess refunded. Prices good through cover month of magazine.

# GODBOUT

GODBOUT ELECTRONICS  
Bldg. 726, Oakland Airport, CA 94614

SEND FOR OUR FREE CATALOG!  
YOU'LL BE GLAD YOU DID.

CIRCLE 36 ON FREE INFORMATION CARD

## GREATLY DISCOUNTED TUBE PRICES

**Audio, Mobile & Receiving Types**  
Huge savings on brand new boxed tubes. Most popular types. Full warranty, best quality. Send for our monthly special discount price list.

Dept. AHK Calvert Electronics, Inc.  
220 East 23rd Street, New York, N.Y. 10010

## MECHANICALLY INCLINED INDIVIDUALS

Assemble electronic devices in your home. Knowledge or experience not necessary. Get started in spare time. Above average profits. \$300-\$600/wk. possible. Sales handled by others. No investment—Write for free details.

**ELECTRONIC DEVELOPMENT LAB**  
Box 1560R, Pinellas Park, FL 33585

# Double up, America.



Two can ride cheaper  
than one.



A Public Service of The Magazine & The Advertising Council



# DELTRONIKS

1. **EMM 4200A. 4K Static RAMs, Ceramic**  
A local memory boards manufacturer closed. We bought the new memory boards and took these 4200A static RAMs out. They are tested and 90-day guaranteed 100% good.

Prime tested 4200A 4K RAMs \$5.50 ea., 32/\$160.00, 300 pieces or more \$4.50 ea.

2. **Static RAMs MK4104 4Kx1 (350 nS)**  
Lrd. Qty. .... \$4.00 ea.

3. **Power SCR's (GEC50A) 100 volt @ 110 amps.** ..... \$6.95 ea.

4. **Squirrel Cage Fans (Howard).** \$7.00 ea.  
5. **Power Diode 1N1202A, 200 volt @ 12 amp.** ..... 4 for \$1.00

6. **LM 323 5 Volt 3 amps. voltage regulator.** 4.95 each or 10/45.00.

7. **Super Saver, Micro PD411, Ceramic 4K x 1 dynamic RAMs.** ..... 8 for \$10.00.



# DELTRONIKS

5151 BUFORD HIGHWAY ✓028  
ATLANTA, GA 30340  
404-458-4690

CIRCLE 44 ON FREE INFORMATION CARD

**ULN2001** High current Drivers Darlingtons **75¢**

**MH0026CJ** DUAL CLOCK DRIVER \$100

**P1103A** 1024 X 1 Dynamic RAM **24¢**

**78H05** 5 AMP 5 VOLT REGULATOR IN TO-3 PKG **\$6.95**

**2716** 450ns single 15V T1. HIT. INT. SGS 16K EPROM **\$38.50**

**8038C** VCO Waveform Gen w/sine **\$275**

7400 TTL		7400 TTL COM'T	
7400	.18	74107	.55
7408	.21	74141	.83
7410	.18	74155	.80
7412	.34	74157	.30
7413	.65	74161	.85
7416	.32	74163	.53
7420	.20	74173	.90
7423	.30	74181	1.35
7427	.32	74189	.93
7437	.28	74279	.78
7438	.28	74347	.75
7440	.18	74393	1.93
7451	.18		
7454	.18	74LS00	.40
7456	.18	74LS03	.33
7474	.35	74LS09	.53
7475	.55	74LS20	.60
7485	.85	74LS26	.40
7490	.50	74LS27	.45
7492	.50	74LS74	.99
7495	.50	74LS82	.55
7495	.70	74LS137	1.50

## TASAs Solid State Micro Proximity Keyboards

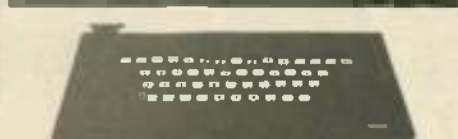

Full QWERTY 8 bit ASCII output plus continuous strobe parity select  
Completely solid state, washable sealed construction  
55 micro proximity sensor positions, three-color coded to function  
Immune to static charge or external noise  
Low power requirement: 15V DC 35mA @ 100% duty in regulator

**\$7500 FROM STOCK**



Model 2016B 16K STATIC MEMORY  
FULLY STATIC OPERATION  
USES 2116 TYPE STATIC RAMS  
+5 VDC INPUT AT LESS THAN 2 AMPS  
BANK SELECT AVAILABLE BY BANK PORT AND BANK BYTE  
PHANTOM LINE CAPABILITY  
ADDRESSABLE IN 4K BLOCKS IN 4K INCREMENTS  
4K BLOCKS CAN BE LOCATED ANYWHERE WITHIN 64K BANK  
MAY BE USED AS A 4K, 8K, 12K OR 16K MEMORY BOARD  
LED INDICATORS FOR BOARD/BANK ACTIVE INDICATION  
SOLDER MASK ON BOTH SIDES OF BOARD  
SILK SCREEN WITH PART AND REFERENCE DESIGNATION  
**ASSEMBLED & TESTED** California Computer Systems **\$297.95**

**63011J** 256X4 PROM **\$265**

**SOROC TERMINAL** \$759.00

T.L./M.M.L. **74LS241** IN **74LS244** STOCK **74LS373** LIMIT 10 EACH **\$2.45**

**I.C. MASTER** 1979 **\$34.95**

**2708** 450ns AMD, SGS 1024X8 EPROM **\$8.50**

**CSC Logic Probe Kit.** **\$1795**

**CONCORD COMPUTER COMPONENTS**  
1973 SO. STATE COLLEGE - ANAHEIM, CA. 92806  
VISA - Master Charge  
Check or M.O. No COD  
Minimum Order - 10.00  
Add 1.50 for Frt.  
Cal. Res. add 6%

MISC TTL COM'T			
74LS165	1.85	LM556	6.85
74LS197	.75	LM718N/K	.38
74S03	.63	LM720R	2.75
74S05	.63	LM723N	.53
74S51	.60	LM725B	3.15
74S182	.99	LM733R	.95
		LM741B/B	.38
LM102B	3.00	LM747R	.80
LM108H	4.50	LM9300	.75
LM300H	1.25	TRANSISTORS	DIGITORS
LM301R	.35	2N2222A	5/1.00
LM311R	.79	2N2907A	5/1.00
LM320TS	1.25	2N3055	.85
LM320MS	1.25	2N3904	8/1.00
LM320T12	1.25	1N5906	6/1.00
LM320T19	1.25	2N4401	8/1.00
LM322K	1.75	2N4403	8/1.00
LM323R	5.50	1N4003	15/1.00
LM320K3	5.00	1N4005	12/1.00
LM340T5	1.25	1N4007	10/1.00
LM340T12	1.25	1N4128	20/1.00
LM340T15	1.25	1N5278	10/1.00

CIRCLE 33 ON FREE INFORMATION CARD



# BSR SYSTEM X-10

## REMOTE CONTROL for Lights & Appliances

- No wires: plug-in operation
- Microprocessor based design
- Built-in keyboard control
- Central Command Console (standard)
- Wireless ultrasonic command system (deluxe)
- Electronic Security & convenience at your fingertips.



4 Pc Standard Starter Kit • One (1) Standard Command Console • Two (2) Lamp Modules • One (1) Appliance Module  
Reg \$87.95... **OUR PRICE \$79.50**

5 Pc Ultrasonic Starter Kit • One (1) Deluxe Ultrasonic Command Console • One (1) Hand Held Remote Unit • Two (2) Lamp Modules • One (1) Appliance Unit  
Reg \$112.95... **OUR PRICE \$99.95**

Lamp Modules Reg \$18... **OUR PRICE \$14.95**

Appliance Modules Reg \$16... **OUR PRICE \$14.95**

Wall Switch Modules Reg \$18... **OUR PRICE \$14.95**

Standard Command Console Reg \$39.95... **OUR PRICE \$36.95**

Ultrasonic Command Console with Hand Held Remote Reg \$65.00... **OUR PRICE \$59.95**

# FORDHAM

855 Conklin Street  
Farmingdale, New York 11735  
MasterCharge • VISA • Check • Money Order • COD  
Add \$3.00 for shipping and insurance • COD's extra.  
N.Y. Res. add sales tax.

Call TOLL FREE (800) 645-9518  
In N.Y. State call (516) 752-0050

# AUTO best buys STEREO



In-Dash 8-Track Stereo Player with AM/FM MPX Radio  
• Push Button eject  
Model C777  
**\$52.50**

In-Dash Cassette Stereo Player with AM/FM MPX Radio  
• Push button eject  
Model CAS 888  
**\$57.50**

In-Dash Auto Reverse Cassette Stereo Player with AM/FM MPX Radio  
• Fast forward rewind  
• Push button eject  
Model CAS 999  
**\$79.95**

Stereo Power Booster Model POW-40  
• 40 Watts Stereo • 20 Watts/Channel  
**\$24.95**



Miniature High Fidelity Stereo Speaker System



6" x 9" 3-Way Speaker  
**\$14.95** ea.  
Model BP 2000-69TR

- 20 oz. ceramic magnet
- Freq Response 60-18000 Hz
- Peak Watts 25W
- Impedance 8 ohms



3-Way Reg \$139.00  
**\$69.50** Per Pr with brackets

- The mini speaker with the MAXI sound
- Soft dome tweeter
- Long throw woofer
- 50 Watts • 8 ohms

# FORDHAM

MasterCharge • Bank America Card • COD • Check • Money Order  
Add \$3.00 for shipping and insurance  
E.O. 12812 Enforce New York State  
residents add applicable sales tax

Call TOLL FREE (800) 645-9518  
In N.Y. State call (516) 752-0050

**HICKOK 3 1/2 Digit Mini-Multimeter**  
Model LX 303  
**\$69.50**

**GOULD 15 MHz Dual Trace**  
Triggers in excess of 25 MHz  
Model OS 25

**SENCORE TV-VTR-MATV and Video Analyzer**  
Model VA48  
**\$945.75**

**ESB CONTINENTAL SPECIALTIES 100 MHz 8-Digit Counter** \$127.50  
• 30 Hz 100 MHz Range • 8 LED Display • Fully Automatic  
• Includes 100 IPC base and most popular manual

**Sinclair PDM35 digital MultiMeter**  
Reg \$68.95  
**\$49.95**

**Weller Controlled Output Soldering Station**  
Model OS 25  
Reg \$115.00  
**\$79.95**

**ESB Digital Capacitance Meter**  
Model 929  
**\$249.95**

**PS500 500MHZ Prescaler**  
Model MAX 100  
**\$59.95**

**CODE-PHONE Telephone Answering Devices**  
Model 1400  
**\$199.95**

**ESB PRECISION 3 1/2-Digit Portable DMM**  
• On-board Processor & Battery for AC operation • 3" High LED Display  
• Auto Zeroing  
Model 9088  
• 3000 counts with 9999  
• 1000 counts with 9999  
• 1000 counts with 9999

**Weller Xcelite**  
Model 100  
**\$195.00**

**Logic Monitor**  
Model 141  
**\$59.95**

**Wahl NEW ISO-TIP "Quick Charge"**  
Model 7000  
**\$29.95**

**Microflame Deluxe Gas Torch Kit**  
Model 4400  
Reg. \$39.95  
**\$29.95**

**NLS 15 MHz Mini Oscilloscope**  
Model MS 15  
Reg \$319.00  
**\$269.95**

**Service Master Attache Style Tool Kit**  
Model 955M  
Reg \$69.95  
**\$47.50**

**Roll Kit**  
Model 959 R  
Reg \$24.95  
**\$19.95**

**HICKOK Oscilloscopes 30 MHz Dual Trace**  
Model 995  
Reg \$199.00  
**\$97.50**

**HICKOK Function Generator**  
Model 270  
Reg \$181.90  
**\$181.90**

**ESB Logic Probe**  
Model LP 1  
Reg \$118.00  
**\$44.95**

**New 3 1/2-Digit DMM with LCD Readout**  
Model 2815  
**\$28.95**

**ESB SUPER SPECIAL Bearcat Scanner**  
Model 250  
Reg \$299.95  
**\$299.95**

**ESB Touch K100 Scanner**  
Reg \$218  
**\$199.95**

**ESB Stereo Power Booster POW-40**  
Reg \$24.95  
**\$24.95**

**ESB 30MHz Dual Trace with Delay Line**  
Reg \$1180.00  
**\$892.50**

**Magnifier LAMP**  
Model MC 10A  
Reg \$49.50  
**\$49.50**

**RC Circuit Box/BCA VIZ**  
• 36 resistors  
• 18 capacitors  
• 100 ohm 1/2 watt  
Model MC 412A  
Reg \$45.95  
**\$42**

**ESB 30MHz Portable Frequency Counter**  
Reg \$130.00  
**\$65.00**

**ESB FREE 1979 Catalog**

**ESB Function Generator**  
Model SCC  
Reg \$127.50  
**\$127.50**

**ESB Chess Challenger**  
Model SCC  
Reg \$74.95  
**\$74.95**

**ESB 700 Series Precision ground and polished magnification lens. Uses 72W T-8 Coolidge Replacement**  
Model 700  
**\$49.50**

**ESB 30MHz Dual Trace**  
Model 995  
Reg \$199.00  
**\$97.50**

**ESB 15 MHz Dual Trace**  
Model 911  
Reg \$76.00  
**\$67.50**

**ESB Logic Probe**  
Model LP 1  
Reg \$118.00  
**\$44.95**

**ESB 3 1/2-Digit DMM with LCD Readout**  
Model 2815  
**\$28.95**

**ESB SUPER SPECIAL Bearcat Scanner**  
Model 250  
Reg \$299.95  
**\$299.95**

**ESB Touch K100 Scanner**  
Reg \$218  
**\$199.95**

**ESB Stereo Power Booster POW-40**  
Reg \$24.95  
**\$24.95**

**ESB 30MHz Dual Trace with Delay Line**  
Reg \$1180.00  
**\$892.50**

**ESB Magnifier LAMP**  
Model MC 10A  
Reg \$49.50  
**\$49.50**

**ESB RC Circuit Box/BCA VIZ**  
• 36 resistors  
• 18 capacitors  
• 100 ohm 1/2 watt  
Model MC 412A  
Reg \$45.95  
**\$42**

**ESB 30MHz Portable Frequency Counter**  
Reg \$130.00  
**\$65.00**

**ESB FREE 1979 Catalog**

**ESB Function Generator**  
Model SCC  
Reg \$127.50  
**\$127.50**

**ESB Chess Challenger**  
Model SCC  
Reg \$74.95  
**\$74.95**

**ESB 700 Series Precision ground and polished magnification lens. Uses 72W T-8 Coolidge Replacement**  
Model 700  
**\$49.50**

**ESB 30MHz Dual Trace**  
Model 995  
Reg \$199.00  
**\$97.50**

**ESB 15 MHz Dual Trace**  
Model 911  
Reg \$76.00  
**\$67.50**

**ESB Logic Probe**  
Model LP 1  
Reg \$118.00  
**\$44.95**

**ESB 3 1/2-Digit DMM with LCD Readout**  
Model 2815  
**\$28.95**

**ESB SUPER SPECIAL Bearcat Scanner**  
Model 250  
Reg \$299.95  
**\$299.95**

**ESB Touch K100 Scanner**  
Reg \$218  
**\$199.95**

**ESB Stereo Power Booster POW-40**  
Reg \$24.95  
**\$24.95**

**"We Will Beat Any Advertised Price"**

# FORDHAM

855 Conklin St Farmingdale, N.Y. 11735



# BULLET ELECTRONICS

P.O. Box 401244-R Garland, Texas 75040 (214) 278-3553

## AY3-8910 PROGRAMMABLE SOUND GENERATOR

The AY3-8910 is a 40 pin LSI Chip with three oscillators, three amplitude controls, programmable noise generator, three mixers, an envelope generator, and three D/A converters that are controlled by 8 BIT WORDS. No external pots or caps required. This chip hooked to an 8 bit microprocessor chip or Bus (8080, Z80, 6800 etc) can be software controlled to produce almost any sound. It will play three note chords, make bangs, whistles, siren's, gunshots, explosions, bleets, whines, or grunts. In addition, it has provisions to control its own memory chips with two IO ports. The chip requires +5V @ 75ma and a standard TTL clock oscillator. A truly incredible circuit.

**\$14.95 W/Basic Spec Sheet (4 pages)**  
60 page manual with S-100 interface instructions and several programming examples. \$3.00 extra

4 DIGIT 1/2 INCH CHARACTER LED DISPLAY  
Bowmar readout stick with colons. COMMON CATHODE ONLY. 100% Prime. All segments and colons brought out to edge pads. With pinout. LIMIT 5 PER CUSTOMER



SPECIAL  
**\$1.90**

9500\*75V Filter Cap  
Computer Grade  
**2.95**

## ZENER GRAB BAG

A very nice assortment of 1/4, 1/2 & 1W zeners. Voltage ranges are from 2.7 to 30 VDC. Most have house # but we provide a cross over list to standard numbers. A great buy for any shop. **12 different types.**

**.50 ea.**

## MC14688 POSITIVE VOLTAGE REGULATOR

1 AMP COMPLETE SPECS AND APPLICATIONS SHOW HOW TO BUILD FIXED OR VARIABLE POWER SUPPLY FROM 3 TO 20VDC DRIVE EXTERNAL SERIES PASS FOR CURRENT TO 20 AMPS

1.35 EA.  
10/10.00



## SE-01 SOUND EFFECTS KIT

• 76477 CHIP IS INCLUDED (EXTRA CHIPS \$2.95 EACH)

• \$16.95  
LESS SPEAKERS & BATTERY

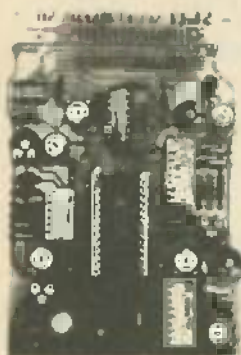

The SE-01 is a complete kit that contains all the parts to build a programmable sound effects generator. Designed around the new Texas Instruments SN76477 Sound Chip, the board provides banks of MINI DIP switches and pots to program the various combinations of the S/F Oscillator, VCO, Noise, One Shot, and Envelope Controls. A Quad Op Amp IC is used to implement an Adjustable Pulse Generator, Level Comparator and Multiple Oscillator for even more versatility. The 3 1/2" x 5" PC Board features a prototype area to allow for user added circuitry. Easily programmed to duplicate Explosions, Phasor Guns, Steam Trains, or almost an infinite number of other sounds. The unit has a multiple of applications. The low price includes all parts.

assembly manual, programming charts, and detailed 76477 chip specifications. It runs on a 9V battery (not included). On board 100mA amp will drive a small speaker directly, or the unit can be connected to your stereo with incredible results! (Speaker not included)

ALLOW 3 WKS. FOR DELIVERY

From T.I. TL490 BAR/DOT DRIVER IC. Drives 10 LED's with adjustable analog steps. Units are cascadable up to 10 (100 steps). Drives LED's directly. Great for voltage, current, or audio displays. Similar in features to LM3914 with specs and circuit notes.

**2.95**

NEW!



## XAN SUPER DIGITS

.6" JUMBO LED  
7 SEGMENT  
RED

**99¢**

6640 COMMON ANODE  
6920 COMMON CATHODE



NOW A SUPER READOUT AT A SUPER BUY! These are factory fresh prime LED readouts, not seconds or rejects as sold by others. Compare our price and send for yours today, but hurry, the supply is limited!

SPECIFY: COMMON ANODE OR COMMON CATHODE

## NEW ITEMS

LM3046	(CA3046) Transistor Array	.75
LM3909	LED Flasher	.50
CA3086	RCA Transistor Array	.80
MC14388	Power Op Amp/Driver	.50
1N4148	Prime, Full Lead	100/2.50
LM3302	Quad Comparator	.89
2SC1649	High Freq NPN TO-92	6/1.00

## POTENTIOMETER ASSORTMENT

A mix of new, panel mount 3/8" bushing pots in various values. Some dual, some with switches.

10/2.00

## 1/2W RESISTOR ASSORTMENT

A good mix of 5% and 10% values in both full lead and PC lead devices. All new, first quality.

(Ass't) 200 pieces/ 2.00

## SLIDE SWITCH ASSORTMENT

An outstanding bargain. Includes miniature and standard sizes and multiposition units. All new first quality, name brand switches. Try one pack and you'll reorder more. SPECIAL — 12 for \$1.20 (Assortment)

- ADD 5% FOR SHIPPING
  - TX RES. ADD 5% STATE SALES TAX
  - FOREIGN ORDERS ADD 10% (EXCEPT CANADA) (20% AIRMAIL) U.S. FUNDS ONLY
  - 30% WE CANNOT SHIP INSURED TO MEXICO
- PRICE'S SUBJECT TO CHANGE WITHOUT NOTICE

## QUAD MATCHED DIODES

4 1N914 type diodes that have been closely matched for use in bridge and balanced modulator circuits.

**50¢ ONE SET (4)**

## PARTS

301 OP AMP @ LEAD CAN	3/2.00
725 VOLT REG. 10 LEAD CAN	.50
1N741 1K5 INPUT ZEN DIODE @ 1/2	1/1.10
30 000 OHM 1/2W COMPUTED GRAD	2.10
78440Z NPN CEN. PURPOSE	8/1.00
78440Z PNP COMPLEMENT	8/1.00
78625 P.M.T. W/SPECS	.50
LM330 2W FUSION IC W/SPECS	1.00
LM337 DUAL LM330 W/SPECS	2.50
7815 VOLT REG. 10 LEAD	.80
7815 LOW NOISE OP AMP	.95
7815 OPTO ISOLATOR 1000V OP	.80
7815 DUAL GATE MOSFET	
DIODE PROTECTOR SWITCH	
TO 40673	.50
MY1824 VARCAP 1000V 10 PFD	.45
1N4003 1K 200V DIODE	15/1.00
TP301 100K PNP POTA	3/1.00
MC1318 P.M.T. @ OSC IC	.50

\*MPC4118 17M @ HOUSE NUMBER

## LED'S

JUMBO GREEN	4/ .99
JUMBO RED	5/ .85
MEDIUM RED 1/4"	15
MEDIUM GRN OR YELLOW	18

## 7 WATT AUDIO AMP KIT

SMALL SINGLE HYBRID IC AND COMPONENTS FIT ON A 2" x 3" PC BOARD (INCLUDED). RUNS ON 12 VDC GREAT FOR ANY PROJECT THAT NEEDS AN INEXPENSIVE AMP. LESS THAN 3% THD @ 5 WATTS. COMPATIBLE WITH SE-01 SOUND KIT

**\$5.95**

## 8 DIGIT AUTO/VAN CLOCK

- 8 CHARACTER LED'S
- QUARTZ REAL TIME BASE
- ALARM & SNOOZE OPTIONS
- BATTERY TESTING
- EASY TO ASSEMBLE
- 4" x 2" x 1 1/2"
- BATTERY & PLASTIC PC BOARD

COMPLETE KIT  
12 VDC **\$16.95**

## ULTRASONIC RELAY KIT

UNUSUAL SOUND WORKS LIKE A PHOTO ELECTRIC EYE. USE UP TO 75 FT APART. COMPLETE KIT. ALL PARTS @ PC BOARD

**\$21.50**

## A RARE FIND! LAMBDA HIGH POWER REGULATOR 3205 MODULE

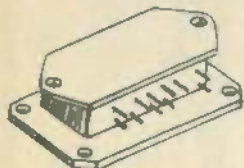

**\$12.95**  
W/SPECS  
LIMITED QTY.

- 5V @ 10A with 8-30VDC Input
- Current limiting, thermal shutdown and short protection
- 2% Load regulation
- Only 2 external components needed.

All you need to add is a transformer, rectifier, heatsink and filter cap to have a super regulated supply for 5 volts at 10 amps!

**SPECIAL BONUS!** Order the 3205 Module and get FREE a LAMBDA L-20-5 overvoltage protector that triggers at 6.6 volts up to 20 amps.

**LAS15U - 1.5A Four Terminal Adjustable Regulator, 3-30V W/current limiting, short protection and thermal shutdown. TO-3 style. All units are prime. Spec sheets included. \$2.50**

- NO COD'S
- SEND CHECK M.O. OR CHARGE CARD NO.
- PHONE ORDERS ACCEPTED ON VISA AND MASTERCARD ONLY (214) 278-3553 9:00 AM - 6:00 PM CST
- ORDERS OVER 1 LB. SHIPPED VIA UPS

P  
O  
L  
I  
C  
I  
E  
S

## 100 W CLASS A POWER AMP KIT

Dynamic Bias Class "A" circuit design makes this unit unique in its class. Crystal clear, 100 watts power output will satisfy the most picky fans. A perfect combination with the TA-1020 low T.I.M. stereo pre-amp.

### Specifications:

- Output power: 100W RMS into 8-ohm
- 125W RMS into 4-ohm
- Frequency response: 10Hz - 100 KHz
- T.H.D.: less than 0.008%
- S/N ratio: better than 80dB
- Input sensitivity: 1V max.
- Power supply:  $\pm 40V @ 5 amp$



**TA-1000 KIT**  
\$51.95  
Power transformer  
\$15.00 each

## SANWA

COMPACT - LIGHTWEIGHT - ULTRA SLIM  
BATTERY CHECKER - LED TESTER  
T-550 (w/o temp probe) \$44.50  
T-55THD (temp probe) \$66.50

### SPECIFICATIONS

#### Ranges

DC Voltage: 150mV, 500mV, 1.5V, 5V, 15V, 50V, 250V, 1kV (All 20k  $\Omega/V$ )

25kV \*Using HV probe)

DC Current: 50mA, 2.5mA, 25mA, 250mA (500mV drop)

AC Voltage: 15V, 50V, (9k  $\Omega/V$ )

AC Current: 6mA, 6A (2V and 55mV drop)

Resistance: 10k $\Omega$ , 100k $\Omega$ , 1M $\Omega$ , 5M $\Omega$  (max. calbtn)

1000 1k $\Omega$

10k $\Omega$ , 50k $\Omega$  (mid scale)

10k $\Omega$ , 100k $\Omega$

Load Current: 30mA 3mA 300mA

Load Voltage: 3V 3V 3V

Decibels: -10 to +55dB

Batt Check: 0.9 to 1.5V (100 load)

LED Check: (Available)

Temperature: -50° to +100°C and 0° to +200°C

Probe not supplied with T-55D)

### Accuracy

DC Voltage:  $\pm 2.5%$  f.s.d.

DC Current:  $\pm 2.5%$  f.s.d.

Batt Check:  $\pm 2.5%$  f.s.d.

AC Voltage/Power on 1.5V range:  $\pm 5%$  f.s.d.

AC Voltage/Power above 15V range:  $\pm 3.5%$  f.s.d.

AC Current:  $\pm 5%$  f.s.d.

Resistance/Temperature:  $\pm 3%$  of arc

Dimensions: 146 x 97 x 28mm thick

Weight: 240g

Instrument supplied with Batteries 1.5V (UM-3 or R6)x2

Fuse & Spare: 500mA 250V

Temperature Probe: TT-55THD Only)

## NEW MARK III 9 Steps 4 Colors LED VU

Stereo level indicator kit with arc-shape display panel!!! This Mark III LED level indicator is a new design PC board with an arc-shape 4 colors LED display (change color from red, yellow, green and the peak output indicated by rose). The power range is very large, from -30dB to +50B. The Mark III indicator is applicable to 1 watt - 200 watts amplifier operating voltage is 3V - 9V DC at max 400 MA. The circuit uses 10 LEDs per channel. It is very easy to connect to the amplifier. Just hook up with the speaker output!

IN KIT FORM \$18.50

## MARK II SOUND ACTIVATED SWITCH KIT



A new designed circuit employed 2 I.C., a DPDT relay with a led indicator. A condenser microphone comms with the kit. The relay can handle up to 200 watts contact to allow to control most things. Just click the finger, the relay will close, the second click will release it. Sensitivity can be adjusted by an on board trim-pot. Operating voltage 9V D.C. TY-18 \$8.50 PER KIT

## MARK IV 15 STEPS LED POWER LEVEL INDICATOR KIT

This new stereo level indicator kit consists of 36 4-color LED (15 per channel) to indicate the sound level output of your amplifier from -36dB to +36B. Comes with a well-designed silk screen printed plastic panel and has a selector switch to allow floating or gradual output indicating. Power supply is 6-12V D.C. with THG on board input sensitivity controls. This unit can work with any amplifier from 1W to 200W!

Kit includes 70 pcs. driver transistors, 38 pcs. matched 4-color LED, all other electronic components, PC board and front panel.



MARK IV KIT \$31.50

## 30W + 30W STEREO HYBRID AMPLIFIER KIT

It works in 12V DC as well! Kit includes 1 PC SANYO STK-043 stereo power amp. IC LM 1458 as pre amp, all other electronic parts. PC Board, all control pots and special heat sink for hybrid. Power transformer not included. It produces ultra hi-fi output up to 60 watts (30 watts per channel) yet gives out less than 0.1% total harmonic distortion between 100Mhz and 10KHz



\$32.50 PER KIT

## BATTERY POWERED FLUORESCENT LANTERN

MODEL 888 R

### FEATURES

- Circuitry: designed for operation by high efficient, high power silicon transistor which enable illumination maintain in a standard level even the battery supply drops to a certain low voltage.
- 9" 6W cool/daylight miniature fluorescent tube.
- 8 x 1.5V UM-1 (size D) dry cell battery.
- Easy sliding door for changing batteries.
- Stainless reflector with wide angle increasing illumination of the lantern.

\$10.50 EA

## STEREO AMPLIFIER



60 W

60 W

### COMPLETED UNIT - NOT A KIT!

DCL pre amp, & power stereo amp. with bass, middle, treble 3-way tone control. Fully assembled and tested, ready to work. Total harmonic distortion less than 0.5% at full power. Output maximum is 60 watts per channel at 8 $\Omega$ . Power supply is 24 - 36V AC or DC. Complete unit. Assembled \$49.50 ea. Power transformer \$ 8.50 ea.

## 5W AUDIO AMP KIT



2 LM 380 with Volume Control  
Power Supply 6 18V DC  
ONLY \$6.00 EACH

## PROFESSIONAL PANEL METERS



Type MU-52E All meters white face with black scales. Plastic cover.

- |             |          |
|-------------|----------|
| A. 0-50uA   | 8.50 ea. |
| B. 0-30VDC  | 8.50 ea. |
| C. 0-50VDC  | 8.50 ea. |
| D. 0-3ADC   | 9.00 ea. |
| E. 0-100VDC | 9.00 ea. |

## 0.5" LED ALARM CLOCK MODULE

### ASSEMBLED! NOT A KIT!

Features: • 4 digits 0.5" LED Displays • 12 hours real time format • 24 hours alarm audio output • 59 min. countdown timer • 10 min. snooze control



ONLY \$7.00 EACH  
SPECIAL TRANSFORMER FOR CLOCK \$1.50 EACH

## DIGITAL AUTO SECURITY SYSTEM

4 DIGITS  
PERSONAL CODE!!  
SPECIAL \$19.95



- proximity triggered
- voltage triggered
- mechanically triggered

This alarm protects you and itself! Entering protected area will set it off, sounding your car horn or siren you add. Any change in voltage will also trigger the alarm into action. If cables within passenger compartment are cut, the unit protects itself by sounding the alarm.

### 3-WAY PROTECTION!

All units factory assembled and tested - NO! a KIT!

## A NEW LED ARRAY AND DRIVER FOR LEVEL METERS

This series covers a wide range of level indication uses, output and input voltage, time related change, temperature, light measurement and sound level. The problem of uneven brilliance often encountered with LED arrangements as well as design problems caused by using several units of varying size are substantially reduced 12 LEDs in one bar.

LED ARRAY	\$5.50
GL-112R3 Red, Red, Red	\$5.50
GL-112N3 Green, Yellow, Red	\$6.50
GL-112M2 Green, Green, Red	\$6.50
GL-112G3 Green, Green, Green	\$6.50

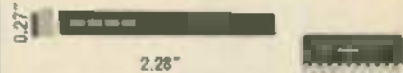

## LED DRIVERS

IR 2406G is an I.C. specially designed to drive 12 LED. The number of LED is linearly illuminated according to the control voltage input terminal 21. Operating voltage is 9 12V D.C. \$5.35 EACH

## PROFESSIONAL FM WIRELESS MICROPHONE

TACT model WEM-16 is a factory assembled FM wireless microphone powered by an AA size battery. Transmits in the range of 88-108MHz with 3 transistor circuits and an omni-directional electric condenser. Element built-in plastic tube type case; mike is 5 1/2" long. With a standard FM radio, can be heard anywhere on a one-acre lot; sound quality was judged very good.

\$16.50

## FLASHER LED

Unique design combines a jumbo red LED with an IC flasher chip in one package. Operates directly from 5V-7V DC. No dropping resistor needed. Pulse rate 3Hz @ 5V 20mA.

2 for \$2.20

## LCD CLOCK MODULE!

• 0.5" LCD 4 digits display • X'tal controlled circuits • D.C. powered (1.5V battery) • 12 hr. or 24 hr. display • 24 hr. alarm set - 60 min. countdown timer • On board dual back-up lights • Dual time zone display • Stop watch function.

NIC1200 (12 hr) \$24.50 EA.  
NIC2400 (24 hr) \$26.50 EA.



## MINI-SIZED I.C. AM RADIO

Size smaller than a box of matches!  
Receives all AM stations.  
Batteries and ear phones included.

Only \$10.50



## 12 DC MINI RELAY

6V	SPDT	2 AMP	1.30
12V	SPDT	3 AMP	1.60
12V	DPDT	2 AMP	2.50
12V	4PDT	3 AMP	3.50



## LINEAR SLIDE POT

5000 SINGLE  
Metal Case 3" Long  
2 FOR \$1.20



## CONDENSER MICROPHONE

Sub-Mini Size  
FET Transistor Built-in \$2.50 each



### FLUORESCENT LIGHT DRIVER KIT



With Case Only  
\$6.50 Per Kit

12V DC POWERED  
Lights up 8 - 15 Watt Fluorescent Light Tubes. Ideal for camper, outdoors, auto or boat. Kit includes high voltage coil, power transistor, heat sink, all other electronic parts and PC Board. Light tube not included!

### THE MOST ADVANCED TIMEPIECE OF ITS KIND IN THE WORLD!

LCD Quartz Alarm Chronograph with calendar and dual time zone!! Watch is the same as Seiko but you pay a lot more for the name!



One Year Full Warranty

- 24 hour alarm • Chronograph counts up to 12 hrs., 59 mins. 59.9 sec. • Precision of chrono up to 1/10 sec. indicated by 10 moving arrows!! • Lap time (with chrono running uninterrupted) • Time displays by LCD for hour, min., sec., day, date of the week and AM/PM • Calendar gives out date-day • Dual time zone for any two cities of the world at your own choice. • With light switch to allow you to see the time in the dark!

Regular Price \$85.50  
SPECIAL \$49.95

### ELECTRONIC DUAL SPEAKER PROTECTOR



Cut off when circuit is shorted or over load to protect your amplifier as well as your speakers. A must for OCL circuits.

KIT FORM  
\$8.75 EA.

### "FISHER" 30 WATT STEREO AMP



Super Buy  
Only \$18.50

MAIN AMP (15W x 2)  
Kit includes 2 pcs. Fisher PA 301 Hybrid IC all electronic parts with PC Board. Power supply ± 16V DC (not included). Power band with (KF 1% ± 3dB). Voltage gain 33dB. 20Hz - 20KHz

### SUPER 15 WATT AUDIO AMP KIT

Uses STK-015 Hybrid Power Amp

Kit includes: STK-015 Hybrid IC, power supply with power transformer, iron! Amp with tone control, all electronic parts as well as PC Board. Less than 0.5% harmonic distortion at full power 1/2dB response from 20-100,000 Hz. This amplifier has DUAET - Complementary class B output. Output max is watt (10 watt RMS) at 4Ω. ONLY \$23.50 each



### HICKOK LX303 DIGITAL LCD MULTIMETER

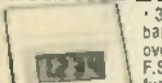

• 3 1/2 digits display • 200 hours 9V battery life • Auto zero; polarity; overrange indication • 100MV DC F.S. sensitivity • 19 ranges and functions • D.C. volt: 0.1 MV to 1000V • A.C. volt: 0.1 V to 600 V • Resistance: 0.1Ω to 20 MΩ • D.C. current: 0.01 A to 100 MA

OUR PRICE \$71.45

### PUSH-BUTTON SWITCH

N/Open Contact  
Color: Red, White, Blue, Green, Black  
3/\$1.00

N/Close also Available  
50¢ each  
LARGE QTY. AVAILABLE

### HEAVY DUTY CLIP LEADS

10 pairs - 5 colors Alligator clips on a 22" long lead. Ideal for any testing

\$2.20/pack

### MANY SOUND DECISIONS!



Solid state sound indicator operating voltage 6V DC 30mA. Small size approximately 3/4" x 1/4".

Model EB2118 (Continuous)  
Model EB2126 (Slow Pulse)  
Model EB2136 (Fast Pulse)

\$3.60 EACH



### ELECTRET CONDENSER MICROPHONE W TIE-CLIP



Sensitivity: 65dB ± 3dB (At 1KHz)  
Impedance: 600 OHM Freq. Response:  
Material: Aluminum 50 15,000 Hz  
Cord: 10 ft. Length \$19.50 EACH

### ELECTRONIC ALARM SIREN COMPLETE UNIT



Ideal for use as an Alarm Unit or hook up to your car back-up to make a reverse indicator. Light Output up to 130dB. Voltage supply 6 12V

AU-999 \$7.50



Sub Mini Size  
PANEL METER  
500 UA  
ONLY \$1.60 ea.

### TRANSFORMERS ALL 117 VOLT INPUT

50V	4 AMP	\$8.50 EA.
36V CT	3 AMP	\$10.50 EA.
48V CT	3 AMP	\$10.50 EA.
24V CT	3 AMP	\$10.50 EA.
24V CT	0.8 AMP	\$2.50 EA.
12V CT	0.5 AMP	\$2.50 EA.
12V CT	120 MA	\$1.80 EA.

### AC POWER SUPPLY

Wall Type Transformer		
12V AC	Output 200 MA	\$2.75 EA.
16V CT AC	Output 100 MA	\$2.10 EA.
6V DC	Output 120 MA	\$1.90 EA.
12V DC	Output 100 MA	\$1.90 EA.

### ULTRASONIC SWITCH KIT



Kit includes the Ultra Sonic Transducers, 2 PC Boards for transmitter and receiver. All electronic parts and instructions. Easy to build and a lot of uses such as remote control for TV, garage door, alarm system or counter. Unit operates by 9-12 DC. \$15.50

### COMPLETE TIME MODULE

0.3" digits LCD Clock Module with month and date, hour, minute and seconds. As well as stop watch function!! Battery and back up light is with the module. Size of the module is 1" dia. Ideal for use in auto panel, computer, instrument and many others! \$8.95 EACH



### SOUND ACTIVATED SWITCH



All parts completed on a PC Board SCR will turn on relay, buzzer or trigger other circuit for 2 - 10 sec. (adjustable). Ideal for use as door alarm, sound controlled toys and many other projects. Supply voltage 4.5V 9V D.C. 2 for \$3.00

\$1.75 ea.

### FM WIRELESS MIC KIT



It is not a pack of cigarettes. It is a new FM wireless mic kit! New design PC board fits into a plastic cigarette box (case included). Uses a condenser microphone to allow you to have a better response in sound pick-up. Transmits up to 350 Ft! With an LED indicator to signal the unit is on. FMM2 KIT FORM \$7.95

### REGULATED DUAL VOLTAGE SUPPLY KIT

30V DC 800 MA adjustable, fully regulated by Fairchild 78MG and 79MG voltage regulator I.C.

Kit includes all electronic parts, filter capacitors, I.C., heat sinks and P.C. board.

\$12.50 PER KIT

3 AA size fast charge (4 hours) NI-CD by Sanyo. All brand new and fresh 450 mah per cell. Limited supply. \$5.40 PER PAK

### BECKMAN FET LIQUID CRYSTAL DISPLAY

Overall size 2" x 1 1/2" 0.5" characters reflective type.

Model 737-01 - for clock 4 digits with PM, alarm, snooze, colon indicators.  
Model 739-04 - for panel meter 4 digits.

Model 739-03 - for panel meter 3 1/2 digits with ± sign and over range indicator.

All displays include zeber connectors and front bezel. With data sheets  
Your choice - any model \$7.50 EACH

88:88

737-01

8888

739-04

888

### POWER SUPPLY KIT

0-30V D.C. REGULATED

Uses UA723 and ZN3055 Power TR output can be adjusted from 0-30V, 2 AMP. Complete with PC board and all electronic parts.

Transformer for Power Supply 0-30 Power Supply  
2 AMP 24V x 2 \$8.50 \$10.50 each



### I.C. TEST CLIPS

Same as the E-2 clips  
With 20" Long Leads  
In Black and Red Colors Per pair

\$2.75



### SOUND GENERATOR I.C.

Creates almost any type of sound - gun shot, explosion, train, car crash, star war, birds, organ ext. A built-in audio amplifier provides high level output. Operates from one 9V battery, 28 pin dip; we supply the datas. \$2.90 EACH



### ELECTRONIC SWITCH KIT

CONDENSER TYPE  
Touch On Touch Off  
uses 7473 I.C. and  
12V relay  
\$5.50 each



### 1 WATT AUDIO AMP

All parts are pre-assembled on a mini PC Board. Supply Voltage 6 9V D.C. SPECIAL PRICE \$1.95 ea.



### LOW TIM DC STEREO PRE-AMP KIT TA-10 20

Incorporates brand-new D.C. design that gives a frequency response from 0Hz - 100KHz ± 0.5dB! Added features like tone delect and loudness control let you tailor your own frequency supplies to eliminate power fluctuation!

Specifications: • T.H.D. less than .005% • T.T.M. less than .005% • Frequency response: DC to 100KHz ± 0.5dB • RIAA deviation: ± 0.2dB • S/N ratio: better than 70dB • Sensitivity: Phono 2MV 47K/Aux. 100MV 100K • Output level: 1.3V • Max. output: 15V • Tone control: bass ± 10dB @ 50Hz/treble ± 10dB @ 15Hz • Power supply: ± 24 D.C. @ 0.5A  
Kit comes with regulated power supply, all you need is a 46V C.T. transformer @ 0.5A

ONLY \$44.50 X'former



### SOLID STATE ELECTRONIC BUZZER

Mini size 1" x 3/4" x 3/4"  
Supply voltage 1.5V - 12V  
Ideal for Alarm or Tone Indicator



\$1.50 each



### FORMULA INTERNATIONAL INC.

1/80

SHIPPING AND HANDLING CHARGES  
Under \$30.00 purchase 1 Over \$30.00 purchase

Send \$1.00 For Detailed Catalogue

12803 CRENSHAW BLVD., HAWTHORNE, CA 90230  
PHONE: (310) 973-1921 • (213) 579-6192

# NEW FROM PTS

## HIGH CURRENT POWER SUPPLIES



**DG-2 Regulated Digital Power Supply/Digital Voltmeter.**  
Single source regulated high current supply with 200V voltmeter for internal and external voltage measurement.



**DG-5 Regulated Voltage Control Center/Digital Voltmeter.** Same high current features as DG-2 plus four independent, variable DC supply voltages. Includes 200V voltmeter for internal and external voltage measurement.



**MSP-501 Regulated Microprocessor Power Supply.** Supply preset to 5 VDC. Adjustable from 4.5 VDC-6.0 VDC. 5 amp.



**PTS ELECTRONICS, INC.**  
The Only Name You Need To Know

P.O. BOX 272, BLOOMINGTON, IN 47402  
See the Yellow Pages for the PTS stocking distributor or Tuner/Module Servicenter nearest you.

CIRCLE 61 ON FREE INFORMATION CARD

### POTTER BRUMFIELD 4 PDT RELAYS

- 14 pin style
  - 2 amp contacts
  - 74 volt d. c. or
  - 120 volt a. c.
- Call  
**\$1.29 each**  
Specify pin style  
LARGE QUANTITIES AVAILABLE



### ELECTRONIC SIREN MODULE \$7.95 each

12-15 vdc 400-750 ma  
warranty period 1000 hrs  
operating 1000-2000 cpm  
and drive has 8 ohm load  
7 1/2 pin DIN



### LINEAR SLIDE POTS

- Approx. 1 1/4 inch long
  - 1 1/8 inch wide
  - 10K or 20K
- 50¢ each SPECIFY VALUE**

### 10 MEG POTS

- Standard 1/4 Watt Size
  - 1 1/2" Long Shaft
  - 1/2" Dia
- 25 For \$6.00 5 For \$1.00**

### 50K AUDIO SLIDE POTS

- 3 1/2 inch long
  - 2 3/8 inch wide
- 75¢ Each**

### COMPUTER GRADE CAPACITORS

- As Brand New
- 60,000 mfd 75 vdc \$1.15
  - 8,000 mfd 75 vdc \$1.45
  - 3,000 mfd 150 vdc \$1.45
  - 2,000 mfd 150 vdc \$1.45
  - 1,000 mfd 150 vdc \$1.45
  - 100,000 mfd 5 vdc \$1.45
  - 20,000 mfd 5 vdc \$1.45



### TANTALUM CAPACITORS

- 15 for \$1.00
- 10 mfd
- 4 vdc

### HEAT SINK DRILLED FOR TWO TO-3 TRANSISTORS

Approx. 4" x 4" x 1"



**SPECIAL PRICE \$1.50 each**

### 1 OHM 175 WATT WIREWOUND RESISTOR \$1.75 each

3 1/2" long, 1 1/8" dia.



### HOUSE MARKED DARLINGTON TRANSISTOR

16 Amps 60 Volts

150 Watts  
Similar to: M4020 PNP \$1.50  
M4023 NPN each  
Specify NPN or PNP



### ROTRON 3 BLADE COOLING FANS

• 115 vdc 14 watts  
• 115 vdc 14 watts  
• 1 1/2" dia

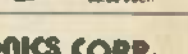

## ALL ELECTRONICS CORP.

SEND FOR OUR FREE FLYER  
905 S. Vermont Ave.  
Los Angeles, CA 90008  
(213) 380-8000  
Store & Warehouse Hours  
9 AM - 5 PM  
Monday thru Friday

- Quantities Limited
- Min. Order \$10.00
- Add \$1.50 Shipping USA
- Calif. Res. Add 6%
- Same Day Shipping with Cert. Check or M.O.

CIRCLE 29 ON FREE INFORMATION CARD

# YOU DESERVE IT!

## GET IT EVERY MONTH!

Come on, treat yourself—and save money, too. Subscribe to Radio-Electronics today, and make sure you get all of the most interesting, most exciting and authoritative electronics reporting in any magazine, month after month. Don't miss a single one of the upcoming issues jam-packed with new-equipment test reports, projects to build, servicing ideas, and news of solid state, computers, hi-fi, hobbies and everything electronic. Save money, too—as much as \$11 off the newsstand price when you subscribe to Radio-Electronics. Come on, you deserve it—check off the money-saving offer you prefer on the handy coupon, and start enjoying Radio-Electronics every month.

## Radio-Electronics



### Get The Authority—Every Month

Name (Please print)

Address

City

State

Zip Code

Indicate the offer you prefer:

- 1 Year—12 issues ONLY \$8.99 (You save \$5.00 off newsstand price.)
- 2 Years—24 issues ONLY \$19.00 (Save More! \$11.00 off newsstand price.)

- Payment enclosed (send one extra issue)
- Bill me
- Check here if you are extending or renewing your subscription.

Extra Shipping Canada \$3.00 per year, all other countries \$5.00 per year.

Mail to: Radio-Electronics  
SUBSCRIPTION DEPT., P.O. BOX 2520 BOULDER, COLO. 80322

These rates are not guaranteed after 9 months.

# Active Electronic Sales Corp.

## Zilog

- Z8001 \$195.00 18 Bit CPU with segmented address space to 8 Megabytes
- Z8002 \$150.00 18 Bit CPU with non segmented address space to 64K bytes
- Z8000DB \$1500.00 A complete single board Z8000 microcomputer system. Contains the Z8002 microprocessor, 16K words of dynamic RAM, 2K word monitor PROM, dual serial interfaces, four counter/timers and 32 programmable parallel I/O lines.

### All Products Stocked in Depth Largest Zilog Inventory

Z80-CPU	2.8 MHz	\$ 9.95	Z80-DMA	2.5 MHz	\$26.95
Z80A-CPU	4.0 MHz	11.95	Z80A-DMA	4.0 MHz	33.80
Z80-PIO	2.5 MHz	7.20	Z80-SIO/0	2.5 MHz	38.00
Z80A-PIO	4.0 MHz	8.40	Z80A-SIO/0	4.0 MHz	39.50
Z80-CTC	2.5 MHz	7.20	Z80-SIO/1	2.5 MHz	38.00
Z80A-CTC	4.0 MHz	8.40	Z80A-SIO/1	4.0 MHz	39.50
			Z80-SIO/2	2.5 MHz	36.00
			Z80A-SIO/2	4.0 MHz	36.50

## MICROPROCESSOR CHIP SETS

Part No.	Price	Part No.	Price	Part No.	Price
8080A	\$5.95	6800	\$8.95	6502	\$9.95
8085	12.95	6802	11.95	6504	9.95
				6505	9.95
8212	3.45	6810	3.95		
8214	3.95	6820	3.95	8520	6.95
8218	3.25	6821	3.95	8522	9.95
8224	2.95	6850	4.25	8532	13.95
8226	2.25	6852	3.95	8551	13.95
8228	3.98				
8238	4.75				
8251	5.75	1802LE	9.95	1854LE	6.95
8253	14.95	1824LE	3.50	1858LE	1.95
8255	5.75	1852LE	1.50	1858LE	1.95
8257	10.95	1853LE	1.45	1859LE	1.50
8259	14.95				

## METAL POWER TRANSISTORS

Homotaxial — Best Quality

2N3054	.85	60V	NPN	TO-66
2N3055	.69	70V	NPN	TO-3
2N3442	1.50	160V	NPN	TO-3
2N3771	1.95	50V	NPN	TO-3
2N3772	1.95	100V	NPN	TO-3
2N3773	2.50	160V	NPN	TO-3

### Universal SCR

C106D	.34	400V	3.0 AMP	TO-220
-------	-----	------	---------	--------

## EPROM'S

C2708	1K x 8	450 ns	\$ 9.95
TMS2716	16K (2K x 8)	450 ns	\$24.95
	(3 power supplies) T.I. Version		
C2716/TMS2516	16K (2K x 8)	450 ns	\$29.95
	(Single 5V supply — Intel version)		



## MOS MEMORIES

Part No.	MOS Static RAM's	Price
2101	1K (256 x 4) 350ns 22 PIN	\$1.95
2102L.FPC	1K (1K x 1) Low Power 350ns 16 PIN	1.18
2102L.HPC	1K (1K x 1) Low Power High Performance 250ns 16 PIN	1.29
2102-1PC	1K (1K x 1) 450ns 16 PIN	0.94
2102-2PC	1K (1K x 1) 850ns 16 PIN	0.91
P2111-25	1K (256 x 4) 250ns 18 PIN	2.25
P2112-35	1K (256 x 4) 350ns 18 PIN	2.25
<b>MOS Dynamic RAM's</b>		
418-B	18K (16K x 1) 300ns 16 PIN	9.95
TMS4060-30	4K (4K x 1) 300ns 22 PIN	2.95
TMS4040-30	4K (4K x 1) 200ns 22 PIN	2.95

### UART's

AVS-1013A	0 to 40K BAUD 40 PIN	4.50
AVS-1015	0 to 30K BAUD 40 PIN Single 5v supply	8.50

### 1K CMOS RAM

5101	1K (256 x 4) 450ns 22 PIN Low Power	3.95
------	-------------------------------------	------

### 4K CMOS RAM

P4315-45L	4K (4K x 1) 450ns 18 PIN	14.85
-----------	--------------------------	-------

### SHIFT REGISTERS

3341PC	FIFO 700 KHz	4.95
3341APC	FIFO 1 MHz	5.50
3342PC	64 Bit Shift Register	4.95
3347PC	80 Bit Shift Register	4.95

### ECL RAM

10410ADC/HM2106	256 x 1 Bit Fully Decoded 15ns 16 PIN	Special 1.85
-----------------	---------------------------------------	--------------

## LINEAR I.C.'s

LM324N	.50	LM741CN-8	.20
LM339N	.50	LM747CN-14	.50
LM348N-14	.99	LM749CN-6	.30
LM555N-8	.29	TL0810DAS	1.29
LM556N-14	.50	LM1458N-8	.40
LM723CN-14	.40	LM3403N-14	.90
LM726CN-8	1.25	LM3900N	.80
LM739CN-14	.29	LM4138N-14	.90

## SOUND & MUSIC GENERATOR I.C.

Creates almost any type of sound, from music to gunshots and explosions. High level amp output. 28 pin DIP. Operates from one 9V battery. With data.

"Lowest Price Offered Anywhere"

SN76477N (.800" centers)	\$2.49
SN76477NF (.400" centers) New small package	\$2.29

## TEXAS INSTRUMENTS Low Profile Sockets

Lowest prices anywhere for the highest quality, an unbeatable combination. Over one million pieces in stock.

Contacts	Price	Contacts	Price
8 PIN	.08	22 PIN	.22
14 PIN	.12	24 PIN	.24
16 PIN	.14	28 PIN	.33
18 PIN	.18	40 PIN	.40
20 PIN	.20		



## Special of the Month 4K STATIC RAM

2114L Low Power \$4.95  
4K (1024 x 4) 300ns

## 1980 IC MASTER

JUST RELEASED over 2700 PAGES

Complete integrated circuit data selector. Master guide to 8th edition I.C.'s including microprocessors and consumer circuit device types listed. 8,000 PDM device types added. Complete new section on MPU boards & Systems.

\$69.95

Free Quarterly Updates

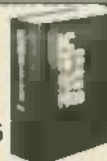

## MICROCOMPUTER BOARDS

### NEC MICROCOMPUTERS TK80A \$299.00

Based on the 8080A the board has both 1K RAM and 1K electrically erasable PROM expandable to 4K x 8 and 8K x 8 on board. Completes with keyboard with 25 row keys and 8 bright 500' digits for display.



### Rockwell International AIM65 \$375.00

As a learning aid AIM65 gives you an assembled, tested and warranted P6502 based microcomputer system with a full sized keyboard, an alphanumeric 20 character display and uniquely, an alphanumeric 20 column thermal printer. An on board Advanced Interface Monitor program provides extensive control and program development functions. 1K RAM.



### Sybertek SYM-1 \$239.00

Fully assembled, tested, documented and expandable. Powerful 6502 8-bit microprocessor. 8 digit test LED display. K&I-1 hardware compatibility. Single plus 5V power requirements.



### Texas Instruments TM990/109 \$333.00 UNIVERSITY MODULE

A complete learning aid that in conjunction with the Tutorial Text offers hands on experience with microprocessors, I/O, memory and assembly language programming. Offers advanced features such as 45 fully alphanumeric keyboard, a powerful instruction set, multiply and divide, vectored interrupts, single bit I/O manipulation, parallel I/O and 7 addressing modes.

## L.E.D. LAMPS

LED209	T-1 3 mm Red	.80
LED211	T-1 3 mm Green	.14
LED212	T-1 3 mm Yellow	.14
LED220	T-1 1/2 5 mm Red	.11
LED222	T-1 1/2 5 mm Green	.19
LED224	T-1 1/2 5 mm Yellow	.18

### DISPLAYS

FND357	375	Common Cathode	1.00
FND367	360	Common Cathode (high brightness)	1.29
FND500	500	Common Cathode	1.09
FND507	500	Common Anode	1.00
FND560	500	Common Anode (high brightness)	1.29
FND567	500	Common Cathode (high brightness)	1.28
DL704	300	Common Cathode	1.29
DL707	300	Common Anode	1.29
DL747	630	Common Anode	2.29

### ISOLATORS

ILD74	Dual Opto Isolator	1500V	1.29
ILD74	Dual Opto Isolator	1500V	3.85
IBCT8	Dual Opto Isolator	1500V	1.29
TC118	Opto Coupler	1500V	.80
4N28	Opto Isolator	2500V	.55
4N28	Opto Isolator	5000V	.50
4N29	Opto Isolator	2500V	.69
4N32	Opto Isolator	2500V	.65

# Active Electronic Sales Corp.

P.O. BOX 1035 FRAMINGHAM, MASSACHUSETTS 01701

Over-the-counter sales.  
12 Mercer Rd. North, Mass. 01750  
Behind Zaynes on Rt. 9  
Telephone Orders & Enquiries (617) 879-0077

MINIMUM ORDER \$10.00 + ADD \$2.00 TO COVER POSTAGE & HANDLING

Foreign customers please remit payment on an international bank draft or international postal money order in American dollars.

### IN CANADA

5851 FERRIER ST.  
MONTREAL, QUEBEC  
H3P 2K5  
Tel. (514) 731-7441

1800 DUFFERIN ST.  
DOWNSVIEW, ONTARIO  
M3H 5S9  
Tel. (416) 661-1115

BAXTER CENTRE  
1050 BAXTER ROAD  
OTTAWA, ONTARIO  
K2C 3P2  
Tel. (613) 820-9471

3076 KINGSBAY  
VANCOUVER B.C.  
V5R 3Y7  
Tel. (604) 436-3321



# COMPARE THESE PRICES!



## OFFERS YOU:

- MONEY SAVING DISCOUNT PRICES
- HARD TO GET COMPONENTS
- TOP SELECTION OF FIRST QUALITY POPULAR COMPONENTS
- ALL COMPONENTS GUARANTEED TO BE FACTORY PERFECT (MONEY BACK GUARANTEE)

<b>WARTS</b>	
AV-8-1013A	84.20
TR18028	2.95
AV-8-10150	6.20
AV-3-1014A	6.75

<b>TELECOMMUNICATIONS</b>	
AV-8-1106 Push Button Telephone Dialer Circuit	13.95
AV-8-9208 Repeater Dialer	13.95
AV-8-9500 C-605 Generator	4.75

<b>GENERATOR/ENCODERS</b>	
AD-3-2513 Character Generator (upper & lower case)	6.60
AV-5-2376 Keyboard Encoder	12.10
AV-5-3090 Keyboard Encoder	12.95

<b>8080/8085/8085 SUPPORT CHIPS</b>	
UPD8080A/C 8-Bit 8-Channel Microprocessor	5.95
UPD8080B/C Single Chip 8-Bit 8-Channel Microprocessor	17.75
UPD8085 Single Chip 8-Bit Microprocessor	13.95
UPD154C 2048 Bit Static CMOS RAM with I/O Ports & Timer	16.95
UPB8212C 8-Bit I/O Port	3.95
UPB8214C Priority Interrupt Controller	3.90
UPB8218C 4-Bit Parallel Bidirectional Bus Driver	13.95
UPB8228C Chip Enable & Strobe for 8088 Processor	2.65
UPB8278C 4-Bit Parallel Bidirectional Bus Driver	3.35
UPB8279C 8088 System Controller & Bus Driver	3.95
UPB8280C 8088 System Controller & Bus Driver	3.95
UPD8243C I/O Expander for Single Chip 8-Bit Microcomputer	6.90
UPD8251C Prog. Communication Interface	6.60
UPD8253C Prog. Interval Timer	13.95
UPD8255C Prog. Peripheral Interface	8.50
UPD8271C Prog. DMA Controller	29.95
UPD8272C Prog. Interrupt Controller	14.90

<b>MICROPROCESSOR CHIPS</b>	
UPD1801CEB 8-Bit 8-Channel Microprocessor-280 compatible	13.50
UPD1801CEB 8-Bit 8-Channel Microprocessor-280 compatible (Alt. dist.)	13.95

<b>CONTROLLER CHIPS</b>	
UPD185 Single Density Density Floppy Disk Controller	58.95
FD17718 Single Density Floppy Disk Controller	58.95
FD17918 Dual Density Floppy Disk Controller (IBM compatible)	58.95
CR15027 CRT Controller	29.95
UPD3720 Floppy Disk Controller	39.95

<b>RAMS</b>	
UPD2102A/C 1024 Bit Fully Decoded Static CMOS RAM (low power)	2.60
UPD2101A/C 1024 Bit (256x4) Static CMOS RAM with 8-bit data I/O (low power)	2.75
UPD2114A/C 1024 Bit (256x4) Static CMOS RAM with common I/O & buffer (low power)	3.50
2114A/CB 4K Static RAM (low power)	1.95
UPD2147D 4K x 1 Bit Static RAM	14.75
UPD4104C 4K x 1 Bit CMOS RAM	11.85
UPD5101C 1024 Bit (256x4) Static CMOS RAM	4.35
UPD4114C 4K Dynamic RAM	4.95
UPD416C 18K (18384x1) Bit Dynamic CMOS RAM	12.75

<b>BAUD RATE GENERATORS</b>	
COM5016 Dual Baud Rate Generator	15.50
COM5036 Dual Baud Rate Generator	19.50
BR1941L Dual Baud Rate Generator	9.90

<b>PROM</b>	
C2716-TMS2516 UV Prom	44.75

<b>SOUND GENERATOR</b>	
SA78477 Complex Sound Generator	3.65

<b>ASTRO</b>	
COM1871 Asynchronous-Synchronous Receiver Transmitter	24.50

<b>LINEAR</b>	
SG3524x/d Switching Regulator Converter	5.40

**TO ORDER:** Specify part number, name, price & quantity. Check or money order must accompany order. Add \$1.75 for postage & handling. New York State residents add 7% sales tax. Foreign Customers: Payment must be in U.S. dollars by international postal money order or cashier's check. Add 20% for shipping & handling.

**FREE GIFT WITH EACH ORDER. WE WELCOME INQUIRIES FROM MANUFACTURERS, DISTRIBUTORS, & INSTITUTIONS. NO C.O.D., MINIMUM ORDER \$10.00.**

(PRICES GOOD THRU JANUARY 15, 1980)

Order Today from:

**POPULAR COMPONENTS INC.**  
1145 WALT WHITMAN RD.  
P.O. BOX 866 DEPT. RE10  
MELVILLE, N. Y. 11747

CIRCLE 54 ON FREE INFORMATION CARD

# ADVERTISING INDEX

RADIO-ELECTRONICS does not assume any responsibility for errors that may appear in the index below.

Free Information Number	Page
30	AMC Sales ..... 90
—	ATV Research ..... 81
57	AP Products, Inc. .... 34
20	Active Electronics ..... 99
—	Advance Electronics ..... 2
5	Advanced Computer Products ..... 87
29	All Electronics ..... 98
13	American Antenna ..... Cov. 4
53	B & K Precision Dynascan Corp. .... 79
32	Babylon Electronics ..... 90
—	Bagnall Electronics ..... 82
—	Karel Barta ..... 81
—	Buller Electronics ..... 95
—	Burdex Security ..... 81
42	CFR Associates ..... 100
—	Calvert Electronics ..... 92
—	Chandler's ..... 13
35	Chaney Electronics ..... 94
18	Channellock ..... 26
—	CIE—Cleveland Institute of Electronics ..... 18-21
—	Command Productions ..... 82
—	Computer Professionals' Book Club— McGraw Hill Book Club Div. .... 67
33	Concord—Computer Components ..... 92
11	Continental Specialties ..... Cov. 2
—	Dage Scientific ..... 82
49	Delta Electronics ..... 90
44	Deltroniks ..... 92
14	Digi-Key ..... 88
—	Digital Research Corporation—DRC ..... 100
47	Electronic Book Club—Tab Books ..... 27
—	Electronic Development Lab ..... 92
—	Electronic Measurements Corp.—EMC ..... 78
34	Fluke ..... 6-7
—	Fordham Radio Supply ..... 93
6-7	Formula International ..... 96-97
59	Fuji-Svea ..... 91
36	Godbout Electronics ..... 92
—	Grantham College of Engineering ..... 75
75, 100, 50	Heath ..... 25, 35, 75
55	Hickok ..... 69
51	Hitachi-Denshi ..... Cov. 3
38	Hobby World ..... 33
—	Information Unlimited ..... 82
29	International Crystal Mfg. Co. .... 77
—	J & A ..... 1
22-23	Jameco Electronics ..... 84-85
10	Jan Crystal ..... 94
—	Lakeside Industries ..... 82
39	McKay Dymek ..... 75
19	Meshna ..... 86
46	Micro Mart ..... 86
—	National Radio Institute (NRI)—Dir. of McGraw Hill ..... 8-11
—	National Technical Schools (NTS) ... 28-31
26, 27	Netronics ..... 71, 76
15, 25	O.K. Machine & Tool ..... 4, 24
—	Olson Electronics ..... 82
8	Optoelectronics ..... 36
56	PAIA ..... 23
61	PTS Electronics ..... 98
40	Pac-Com ..... 80
45	Panavise ..... 78
28	Poly Paks ..... 86
54	Popular Components ..... 102
9	Quest ..... 83
—	RCA ..... 22, 23
17	Radio Shack ..... 89
31	Ramsey Electronics ..... 101
3	Rye Industries ..... 77
16	SGL Waber ..... 73
—	Sabtronics ..... 15, 17
2	Schober Organ ..... 70
24	Solid State Sales ..... 94
—	Spacecoast Research ..... 94
48	Sprague Products ..... 80
—	Surplus Center ..... 94
43	Tek-El Corp. .... 100
52	Texas Tuner Service ..... 78
12	Tri-Star ..... 100
41	Vector ..... 70
21	Went Electronics ..... 73
4	Zemco ..... 37

## MOVING?

Don't miss a single copy of Radio-Electronics. Give us:

Six weeks' notice

Your old address and zip code

Your new address and zip code

ATTACH LABEL HERE

name (please print) \_\_\_\_\_  
address \_\_\_\_\_  
city state zip code \_\_\_\_\_

Mail to: Radio-Electronics  
SUBSCRIPTION DEPT., P.O. BOX 2520,  
BOULDER, COLO. 80322



## HITACHI OSCILLOSCOPES

Single and dual trace, 15 and 30 MHz. All four high sensitivity Hitachi oscilloscopes are built to demanding Hitachi quality standards and are backed by a 2-year warranty. They're able to measure signals as low as 1mV/division (with X5 vertical magnifier). It's a specification you won't find on any other 15 or 30 MHz scopes. Plus: Z-axis modulation, trace rotation, front panel X-Y operation for all four scope models, and X10 sweep magnification. And, both 30 MHz oscilloscopes offer internal signal delay lines. For ease of operation, functionally-related controls are grouped into three blocks on the color coded front panel. Now here's the clincher: For what you'd expect to pay more, you actually pay less. Suggested list price of our top line V-302 dual trace 30 MHz is only \$945.00. The other models comparably less. Check our scopes before you decide.

## Hitachi...The measure of quality.

- V-302 30 MHz Dual Trace \$945.00
- V-301 30 MHz Single Trace \$745.00
- V-152 15 MHz Dual Trace \$695.00
- V-151 15 MHz Single Trace \$545.00



**HITACHI**  
Hitachi Denzhi America, Ltd.

For more information, contact  
Hitachi Denzhi America, Ltd.,  
175 Crossways Park West, Woodbury, N.Y. 11797  
(516) 921-7200.

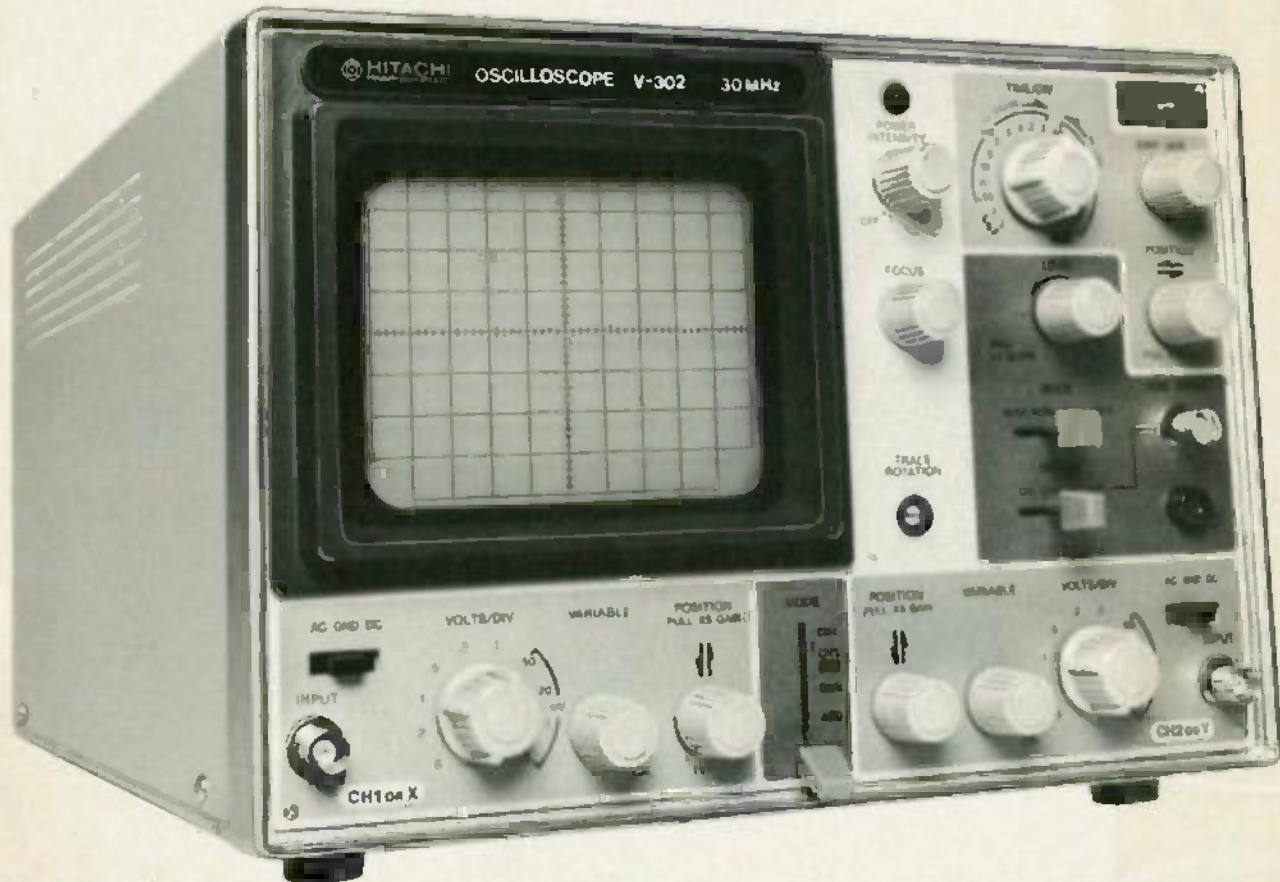

# More sensitive to your input.

CIRCLE 51 ON FREE INFORMATION CARD.

# In one year our **K40** antenna has become the largest selling CB antenna in the world!

**1. It's the most expensive...**

**2. It's made better...**

**3. It's proven best!**

...Here's what the leading CB publications said.

**\$42.50**

suggested retail

**And when you pay more, you expect more!**

**MORE PERFORMANCE:**

The K40 is guaranteed to transmit further or receive clearer than any antenna it replaces. We know it will. We've tested it with 771 CB'ers just like you for one year.

**MORE FLEXIBILITY:**

You can fit your K40 to any mounting surface. It will fit any vehicle you'll ever own! That includes choppers, dune buggies, gutters, mirror mounts, luggage racks, trunks, hatchbacks, through roofs, semis, pick ups and RV's.

**MORE QUALITY:**

It's not imported. It's not made in Taiwan, Korea or Japan. It's American made in an American town. It's made with better materials that cost more and by professional people we pay more. And we designed it right here in the U.S.A.

\*Including optional mounts at extra cost.

**...This Antenna is so DYNAMITE you receive a ...**

**DOUBLE GUARANTEE**

**GUARANTEE I:** The K-40 will transmit further and receive more clearly than the antenna it replaces or the customer will receive a prompt cash full refund from the Registered K-40 Dealer who installed and tuned it.

**GUARANTEE II:** Unconditionally guaranteed for 12 months. Guaranteed against: grinding, chipping, or rubbing. Guaranteed against mechanical failure. Guaranteed against electrical failure. Guaranteed against accidental breakage. No exclusions. No gimmicks. For a full 12 months.



**CB TIMES:** "... it's not often that a product bursts onto the market scene, dominates and improves CB'ing for everyone. American Antenna and the K40 are doing it—repeated tests showed the K40 could out-perform the major competitive brands."

**RADIO-ELECTRONICS:** "The results of our tests showed that in three different positions of the monitoring receiver, the model K40 equaled or out-performed the competitive antenna. Apparently, American Antenna's advertising is not merely Madison Avenue showmanship."

**PERSONAL COMMUNICATIONS:** "... an impressive 95% of the trials, the K40 out-performed the existing mobile antennas. We had to try one for ourselves. ... In every case, the K40 either equaled or out-performed its competitor."

"No ifs, ands, or butts! The K40 Antenna from American Antenna would have to be just about the best antenna around."

**CB MAGAZINE:** "Introduced in October, 1977, the K40 quickly became the top seller and in mid 1978, became the number one selling antenna in the nation."

**...Here's what CB'ers all across the country said.**

**ANTENNA SPECIALISTS:** "... truck driver and CB'er for 10 years ... 50% further than my M410 'Big Momma'."

—J.H. Collett, 207 McFee, Bastrop, LA

**AVANTI:** "I'm an electronic technician with a Second Class FCC license ... I was able to transmit 70% further and tune the SWR 75% lower than my AvantiL."

—H.R. Castro, YRB, Monserrate D-87, Salinas, Puerto Rico

**PAL:** "... 20% better in transmission and reception than my 5/B wave Pal Firestik."

—John A. Baum, Box 448, Zanesville, PA

**SHAKESPEARE:** "... I've been a CB'er for three years and the K40 is the best I've ever had. Better in reception and transmission than my Shakespeare."

—H. Becherl, Jr., 15 King Rd., Park Ridge, NJ

**HUSTLER:** "Compared to my Hustler XBLT-4, the K40 can consistently transmit 40% further and the reception was better. The K40 is the perfect way to complete a CB system."

—Jerome R. Brown, 7800 S. Linder, Burbank, IL

GOOD STUFF FOR PROS ONLY!



**(SPECIAL NOTE) IF YOU'RE A BEGINNER:**

Our K40 Dealers will be happy to sell you any of the older style and less expensive antennas that are great bargains for any beginning CB'er.

**AMERICAN ANTENNA**  
ELGIN, IL 60120  
COPYRIGHT AMERICAN ANTENNA 1979

**K40 POWER!**

... Sold exclusively by American K40 Dealers throughout the U.S. & Canada.

CIRCLE 13 ON FREE INFORMATION CARD